

Running Board Installation Instructions 82081 (1" Drop)

Dodge Ram 2014-Current

Read instructions before beginning installation (No Drilling)

INSTALLATION PACKAGE

Running Board	2
Brackets (Driver Front / Passenger Rear)	2
Brackets (Passenger Front / Driver Rear)	2
Bracket (Driver Middle)	1
Bracket (Passenger Middle)	1
Bolt Pack (Boards & Brackets)	2

Necessary Tools

Combination wrench or sockets with 13mm & 1/2"
Safety glasses

Bolt Pack Brackets

5/16 x 1" (Black)	12
M8 x 1.25 x 25mm	6
5/16 or 1/4" USS Flat Washer	30
5/16 Serrated Flange Nut	18
Bolt Plate 1 3/4" x 1/2" with a 5/16 x 1 1/4" Bolt	6
Plastic Bolt Retainer 3" long hole on end	6
Plastic Bolt Retainer hole in center	6

Bolt Pack Running Boards

5/16" x 3/4" Hex Bolt	12
5/16" Serrated Flange Nut	12

Step 1: Reference picture of bracket positions for later steps. Regular cabs use only 4 brackets (Driver & Passenger Middle brackets are not used).

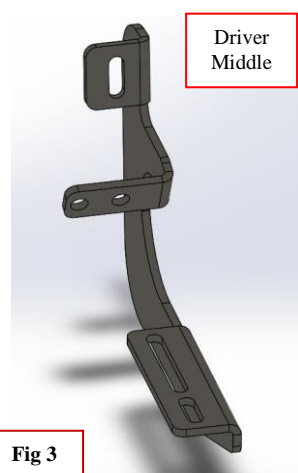
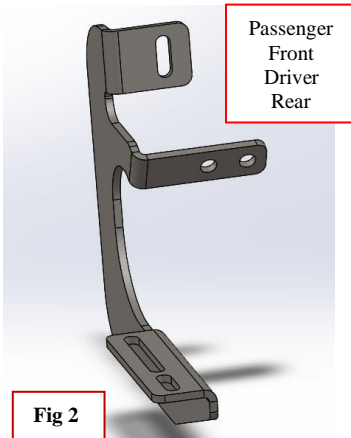
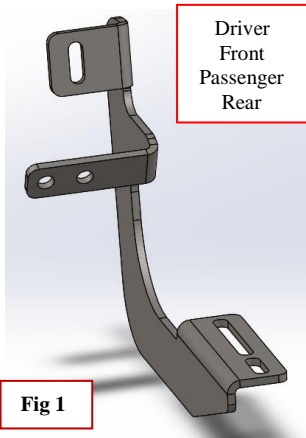

Step 2: There are 3 factory mounting location underneath your truck below the doors pictured below (Fig 5 & 6) Front, Middle and Rear on each side of the vehicle. Look for 2 hex holes or 8mm threaded inserts and a bigger oval hole with tape over it. We will only use these factory locations to mount the brackets.

A) If your truck looks like (Fig 5) threaded inserts. Skip to Step 6.

B) If your truck looks like (Fig 6). Continue to Step 3.

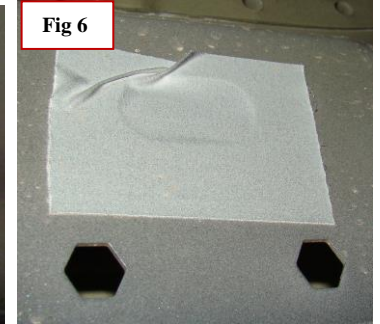
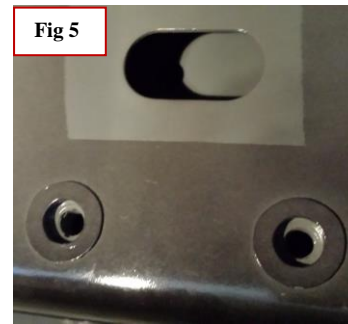

Step 3: We need to remove the factory tape at each location. Peel it off and keep it clean. It can be put back to its original place after the bolt plate is installed.

Step 4: Obtain the bolt plate and longer plastic retainer with hole on end. Twist on bolt like a nut until plastic almost touches metal plate. Then bend end at angle about 3/4" from end. When complete it looks like (Fig 8) and is ready to install.

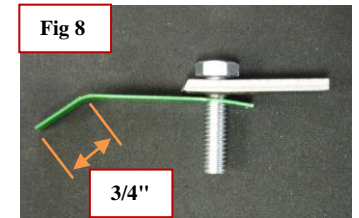
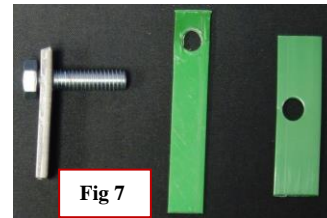

Step 5: Next insert the bolt plate as shown (Fig 9). You are going to rotate or twist the plastic retainer and get it to come out through the hex hole and hold it in place (Fig 11). Take one of the plastic retainers with the hole in the center (Fig 7) and screw it on to hold the bolt in place and stop it from falling in the rocker panel (Fig 12). Install as indicated below.

A) Driver Front, Driver Middle & Passenger Rear locations (Fig 11)

B) Passenger Front, Passenger Middle & Driver Rear the bolt plate should be installed in the right side hole not shown.

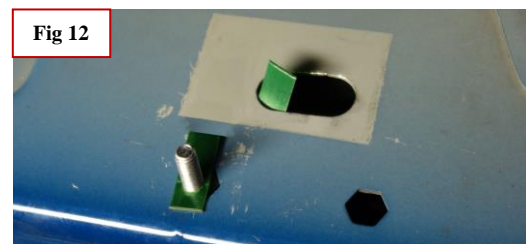
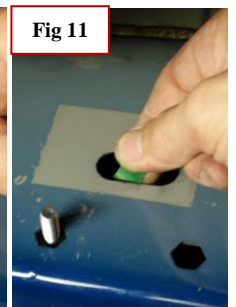
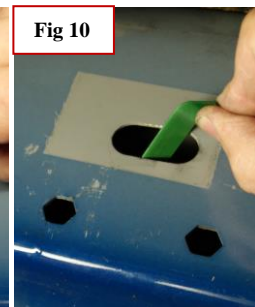

Step 6: Trucks that are equipped with threaded inserts do not require the bolt plates.

Front Driver: Place bracket over bolt plate and attach with M8 nut with washer. If treaded insert attach with M8 x 25mm bolt with washer. Now install Black 5/16 x 1" bolt with washer through lower pinch weld hole and bracket. Then secure with washer and 5/16 nut. Hand tighten or snug all fasteners to hold bracket in place but do not tighten.

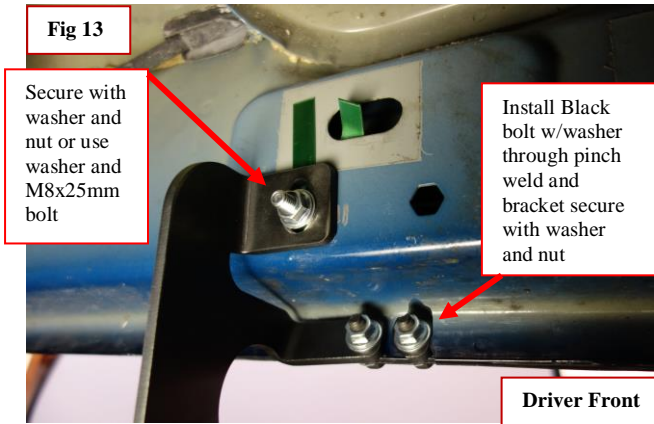

Step 7: Middle Driver will install the same as the front it will use (2) bolts in the pinch weld. Snug all fasteners to hold bracket but do not tighten.

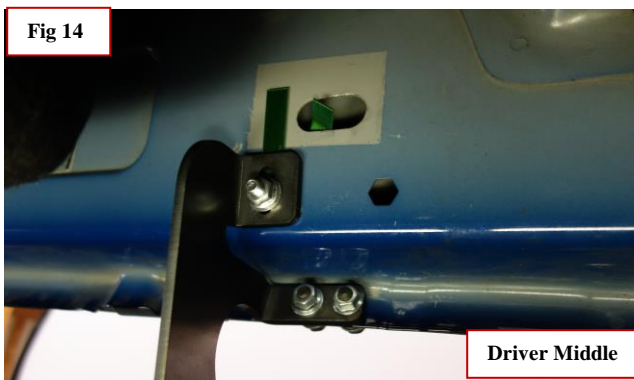

Step 8: Rear Driver will install the same as the front and middle brackets. It will use (1) bolts in the pinch weld. Snug all fasteners to hold bracket but do not tighten.



Step 14: This will show you the location and what the brackets should look like after you have them installed on the vehicle. The driver and passenger will look the same.

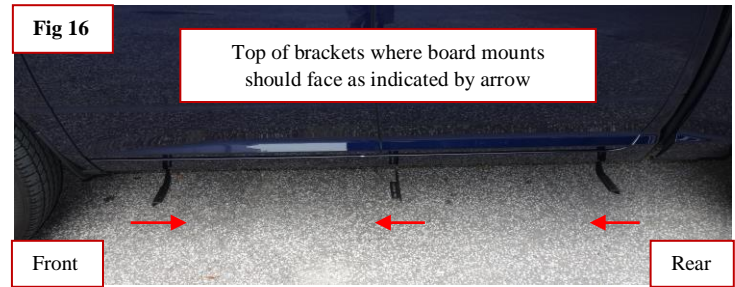

Step 9: Now install running boards on the brackets. Obtain the bracket to board bolt pack. Take out the provided 5/16" x 3/4" bolts. Slide the head of the bolts down the channels on the underside of the board.



Step 14: Place the board on the installed mounting brackets. Align the bolts with the slots on the brackets and drop them into place. Next thread the provided 5/16" flange nuts onto the bolts to hold the board and leave loose. Adjust the board in or out, right or left to meet your needs. Once the boards are in place to your liking, tighten all fasteners on the brackets. Front and rear first and then the center brackets finally the boards. This will complete your installation. Enjoy!

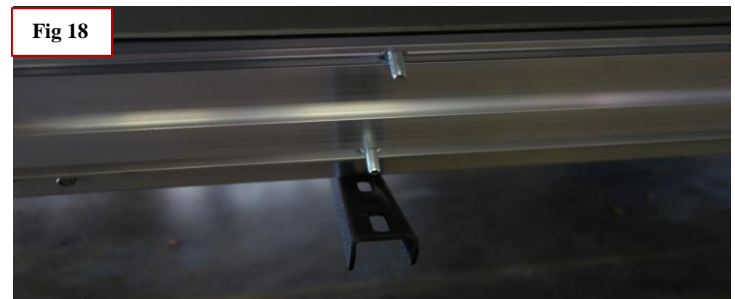

Step 15: To view the instructions with clear pictures that can be zoomed in and out. Please visit our instruction page at the web address below.

www.runningboardwarehouse.com/installationinstructions.aspx