

744000

RUNNING BOARD

Components:

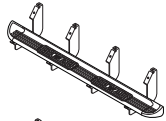

Driver Side
Running Board Assembly
Qty. 1
(Brackets already attached)

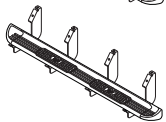

Passenger Side
Running Board Assembly
Qty. 1
(Brackets already attached)

Hardware:



M8 X 30MM
Hex Head Bolts
Qty 16

1. Remove all contents from the package and check stainless steel running boards for any damage. Also, verify that all components and hardware listed above are included before you begin installation.

2. Begin installation on driver's side of vehicle.

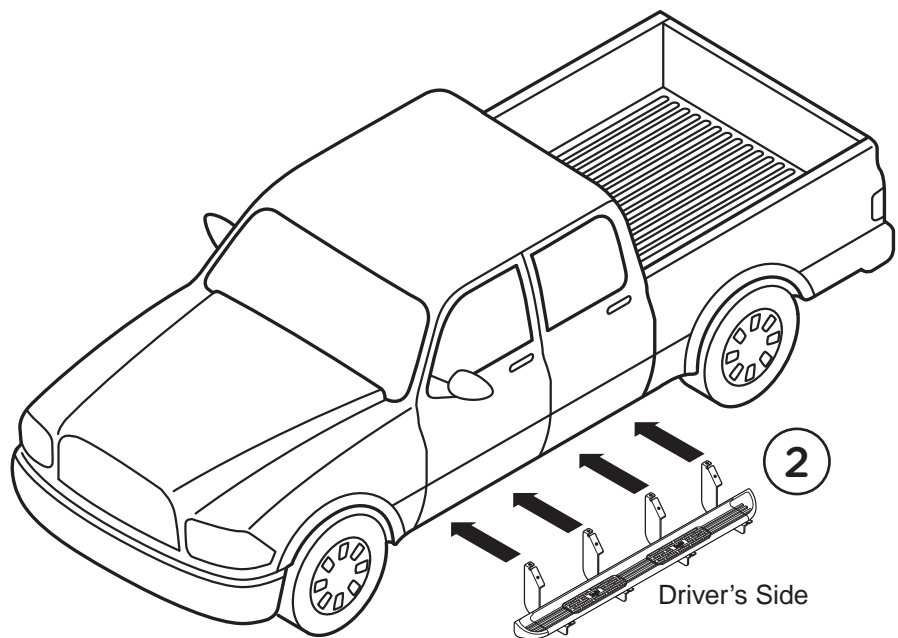

3. Align all four (4) Driver's Mounting Brackets with the pre-threaded holes located in the rocker panel on the under side of the truck.

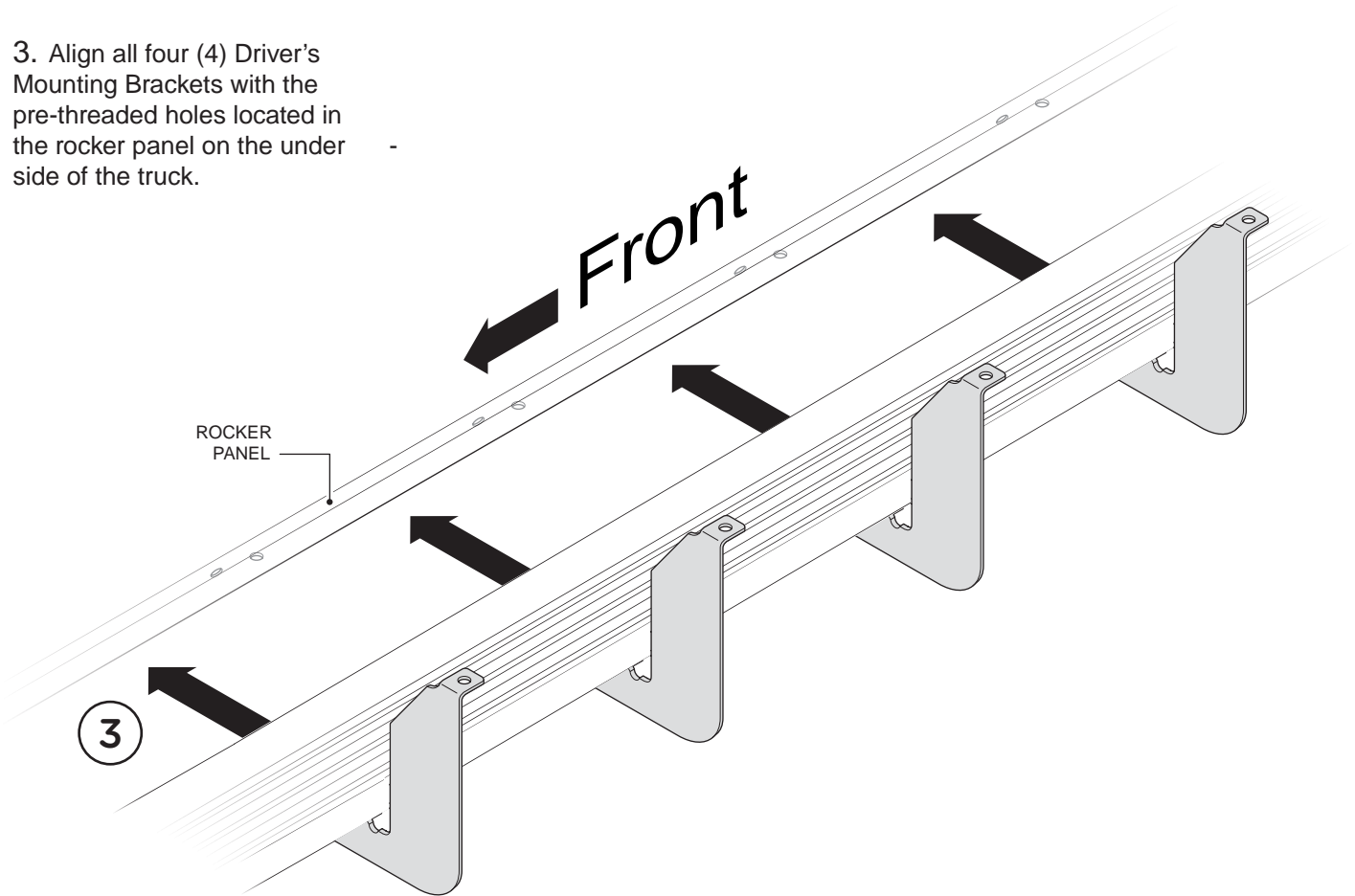

4. Fasten Driver's Side Brackets to the Rocker Panel using two (2) M8 x 30MM Hex Head Bolts, two (2) M8 Lock Washers, and two (2) M8 Flat Washers per bracket.

Repeat these steps for driver side installation. When all hardware is in place, everything must be tightened. See Page 1 for Torque Specifications.

