

RUNNING BOARD

Components:

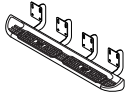

Driver Side
Running Board Assembly
Qty. 1
(Brackets already attached)

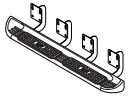

Passenger Side
Running Board Assembly
Qty. 1
(Brackets already attached)

Hardware:



M8 x 30 mm
Hex Head Bolts
Qty 24



Teon
Washer
Qty 4



M8 Flat
Washers
Qty 24



M8 Lock
Washers
Qty 24



M8 U Nut Clip
Qty 24

1. Remove all contents from the package and check stainless steel running boards for any damage. Also, verify that all components and hardware listed above are included before you begin installation.

2. Read installation manual and installation drawing completely. Understand all brackets and bolts before installation.

3. Begin installation on passenger side.

4. Existing mounting holes are located on the interior wall of the rocker panel. These mounting holes will be used per the following instruction.

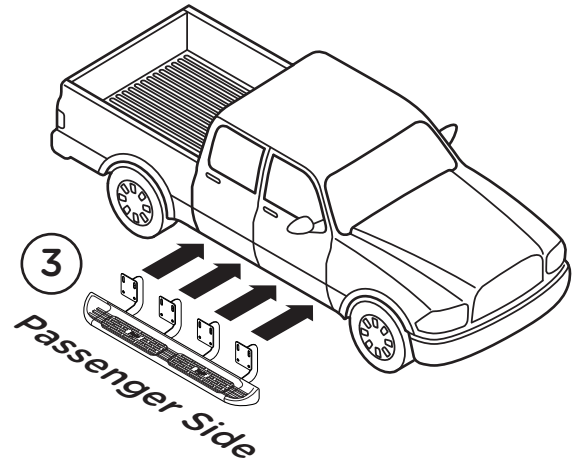

5. For the Front Brackets on the vertical wall of each rocker panel, install the three (3) U-Nuts as shown. Two (2) U Nut Clips are to be installed covering the two (2) mount holes and one (1) U Nut Clip is to be installed on the bottom of the body panel. Install these U Nut Clips so that the threads are to the inside of the rocker panel. Be careful not to drop the U Nut Clip inside of the rocker panel.

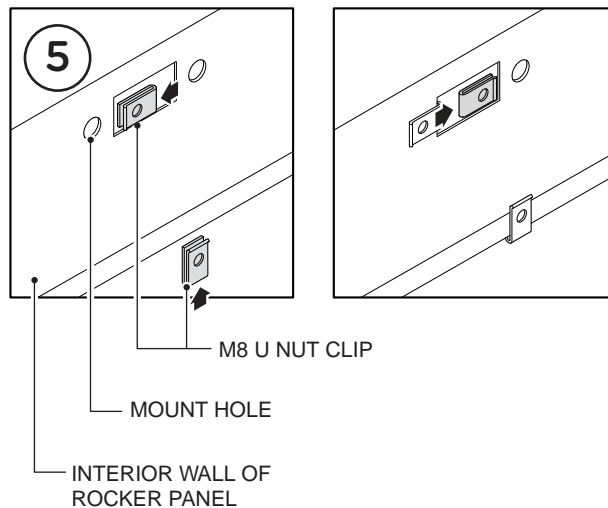

6. For the Center and Rear Brackets, on the vertical wall of each rocker panel, install the three (3) U Nut Clips as shown.

One (1) U Nut Clip is to be installed covering the one (1) mount hole toward the front of vehicle and two (2) U Nut Clips are to be installed on the bottom of the body panel. Install these U Nut Clips so that the threads are to the inside of the rocker panel. Be careful not to drop the U Nut Clip inside of the rocker panel.

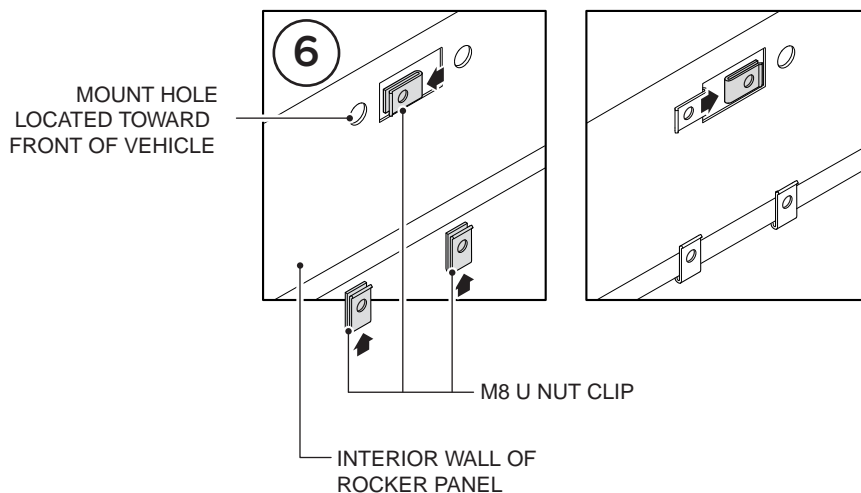

7. Install the passenger side Front Bracket by fastening two (2) M8 x 30 mm Hex Head Bolts, two (2) M8 Flat Washers, two (2) M8 Lock Washers and two (2) Te on Washers through the top two oblong holes and into the M8 U-Nuts.

8. Complete the installation of the Front Bracket by fastening one (1) M8 x 30 mm Hex Head Bolt, one (1) M8 Flat Washer and one (1) M8 Lock Washer through the bottom hole facing to rear of vehicle and into the M8 U Nut Clips.

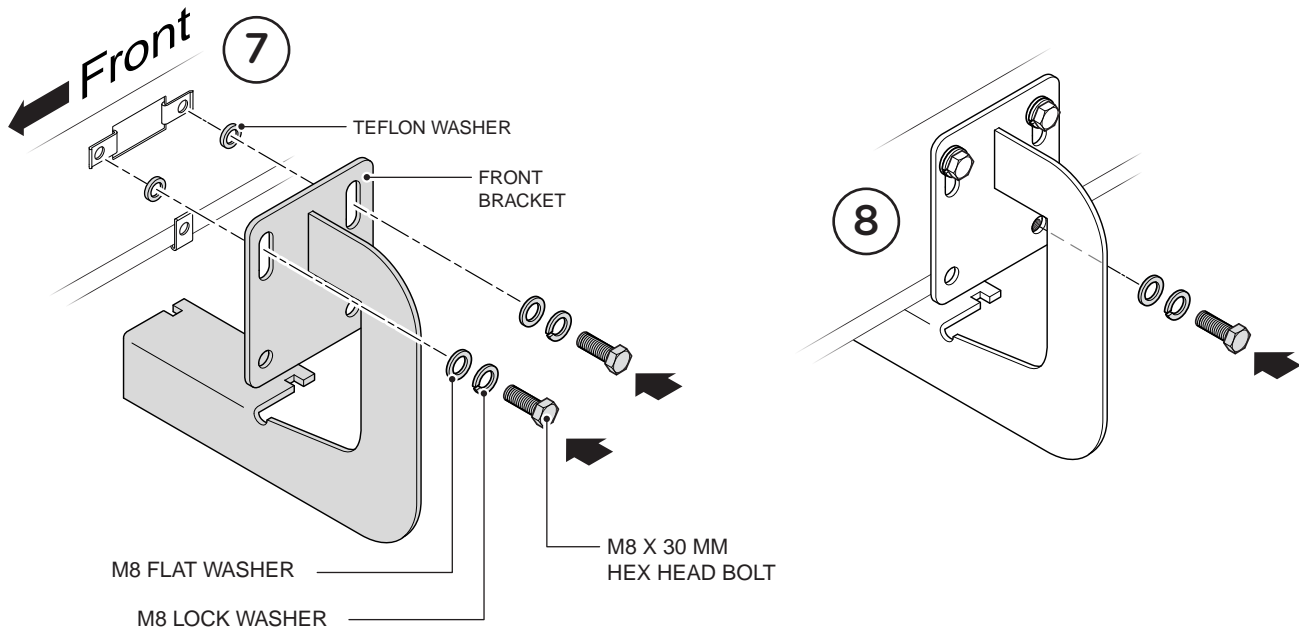

9. Install the passenger side Center and Rear Brackets by fastening one (1) M8 x 30 mm Hex Head Bolt, one (1) M8 Flat Washer and one (1) M8 Lock Washer into top oblong hole located toward the front of vehicle and into the M8 U Nut Clips.

10. Complete the installation of the Front Bracket by fastening two (2) M8 x 30 mm Hex Head Bolts, two (2) M8 Flat Washers and two (2) M8 Lock Washers through the bottom holes and into the U Nut Clips.

Repeat these steps for driver side installation. When all hardware is in place, everything must be tightened. See Page 1 for Torque Specifications.

