

RUNNING BOARD

Components:

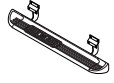

Driver Side
Running Board Assembly
(Brackets already attached)
Qty 1



Passenger Side
Running Board Assembly
(Brackets already attached)
Qty 1

Hardware:



M8 x 30MM
Hex Head Bolt
Qty 16



M8 Flat Washer
Qty 16



M8 Lock Washer
Qty 16



M8 U Nut Clip
Qty 16

1. Remove all contents from the package and check stainless steel running boards for any damage. Also, verify that all components and hardware listed above are included before you begin installation.

2. Read installation manual and installation drawing completely. Understand all brackets and bolts before installation.

3. Existing mounting holes are located on the interior wall of the rocker panel. These mounting holes will be used per the following instruction.

4. On the vertical wall of each rocker panel, install the U Nut Clips into two round holes. Install these U Nut Clips so that the threads are to the inside of the rocker panel. Be careful not to drop the U Nut Clips inside of the rocker panel.

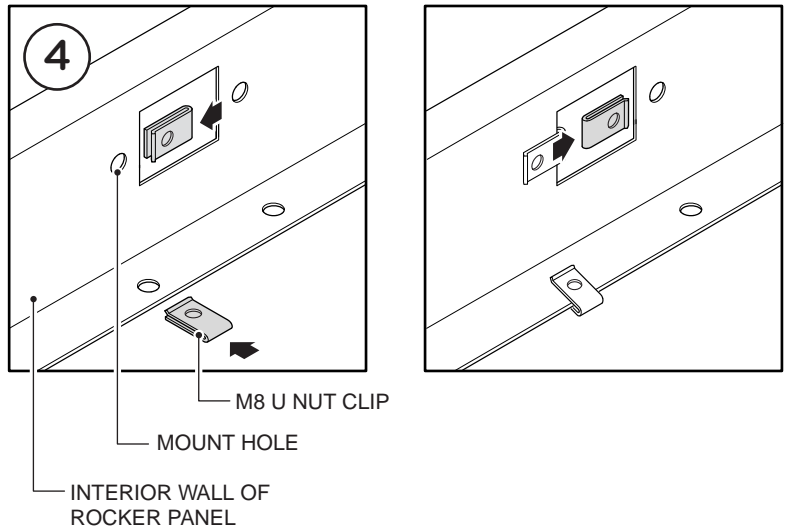

5. Install the Passenger Side Brackets by using two (2) M8 x 30MM Hex Head Bolts, two (2) M8 Flat Washers and two (2) M8 Lock Washer through the top two oblong holes and into the M8 U Nut Clips.

6. Complete the installation of the Brackets by fastening two (2) M8 x 30MM Hex Head Bolts, two (2) M8 Flat Washers and two (2) M8 Lock Washers through the bottom two oblong holes and into the M8 U Nut Clips.

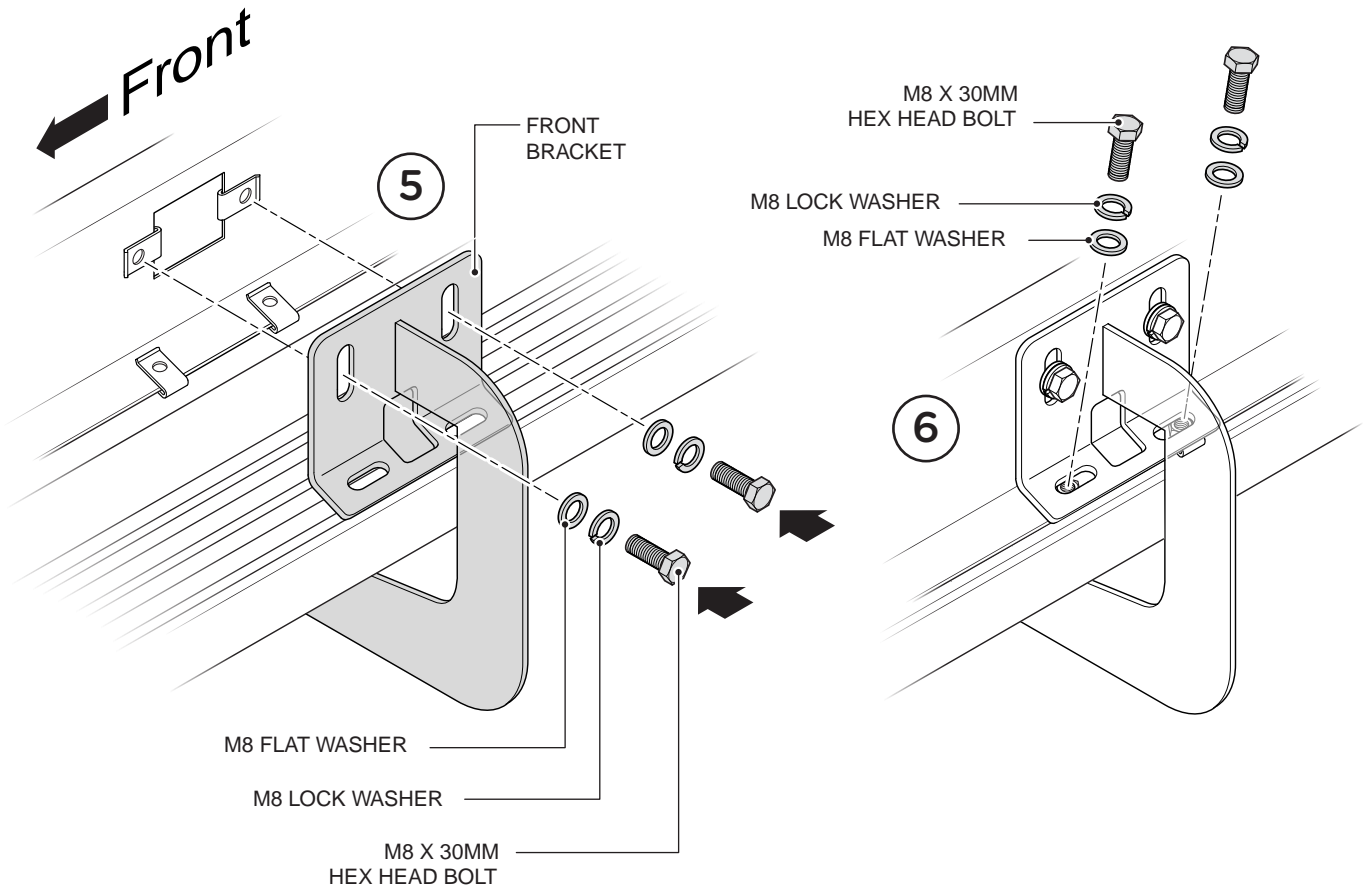

Repeat these steps for driver side installation. When all hardware is in place, everything must be tightened. See Page 1 for Torque Specifications.