

6" OVAL BAR

Components:

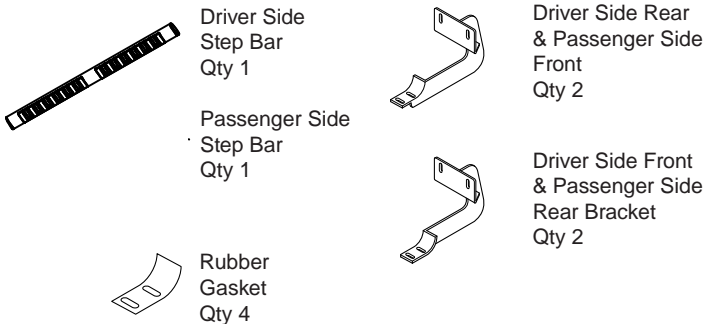

Hardware:



1. Remove all contents from the package and check stainless steel tubes for any damage. Also, verify that all components and hardware listed above are included before you begin installation.

2. Remove the black tape and large rubber grommets over the mounting holes located on the inside face of the rocker panel.

3. Existing mounting holes are located on the interior wall of the rocker panel. These mounting holes will be used per the following instruction.

On the vertical wall of each rocker panel, install the U Nut Clips as shown for both front and rear brackets for the top hole positions of only. Install these U Nut Clips so that the threads are to the inside of the rocker panel. Be careful not to drop the U Nut Clips inside of the rocker panel.

4. On the passenger side of the vehicle, align the Front and Rear brackets as shown.

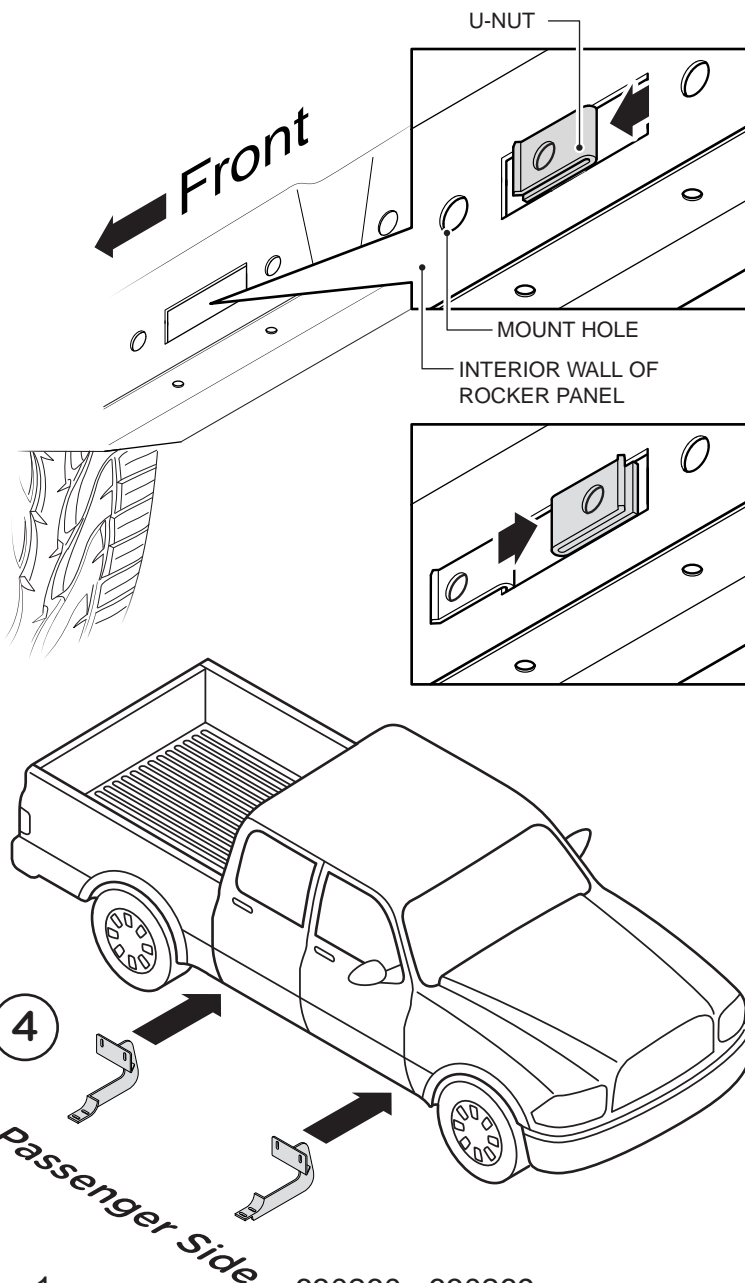

5. Install the Top Flange of the passenger side Front Bracket by fastening two (2) M10 x 30 mm Hex Head Bolts, two (2) M10 Flat Washers and two (2) M10 Lock Washers into M10 U Nut Clips.

6. Complete the installation of the Front Bracket by using two (2) M10 Hex Head Nuts, four (4) M10 Flat Washers and two (2) M10 Flat Washers. Repeat this process for the Rear Bracket. Hand tighten all hardware.

7. Place the Step Bar and Rubber Gaskets onto the Brackets. Each Step Bar is marked Driver and Passenger.

8. Install the Step Bar onto each Bracket using two (2) M10 X 30MM Button Head Bolts, two (2) M10 Lock Washers and two (2) M10 Flat Washers.

Tighten until the split lock washer is at against bracket and snug. DO NOT over tighten and strip the threaded insert in the tube.

Repeat these steps for passenger side installation. When all hardware is in place, everything must be tightened. See Page 1 for Torque Specifications.

