















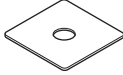
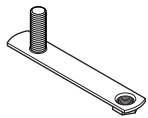

5" OVAL BAR





Components:

-  Driver Side Step Bar Qty 1
-  Passenger Side Step Bar Qty 1
-  Driver Side - Rear Bracket Qty 1
-  Driver Side - Front & Center Bracket Qty 2
-  Passenger Side - Front & Center Bracket Qty 2
-  Passenger Side - Rear Bracket Qty 1
-  Rubber Gasket Qty 6

Hardware:

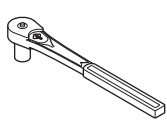
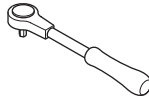
-  M8 x 40MM Hex Head Bolt Qty 6
-  Plastic Push Nut Qty 6
-  M12 Bolt + M10 Nut Plate Qty 6
-  M10 x 40MM Hex Head Bolt Qty 6
-  M12 Flat Washers Qty 6
-  M10 x 30MM Button Head Bolts Qty 12
-  M12 Lock Washers Qty 6
-  M10 Flat Washers Qty 18
-  M12 Hex Head Nut Qty 6
-  M10 Lock Washers Qty 18

Tools Required:

-  RATCHET
-  TORQUE WRENCH
-  19MM SOCKET
-  17MM SOCKET
-  6MM HEX BIT

Torque Specifications:

For Rocker Panel Mount Installations
M8 through M12 bolts and nuts are set to 15-20 ft lbs.

Note: When installing the brackets and bars, all hardware must be left loose until all the items are attached.

1. Remove all contents from the package and check stainless steel tubes for any damage. Also, verify that all components and hardware listed above are included before you begin installation.

2. Locate factory holes in six (6) places underneath body mount.

Passenger Side

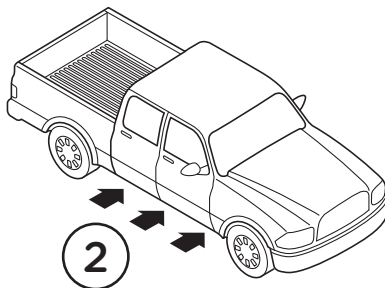

Driver Side

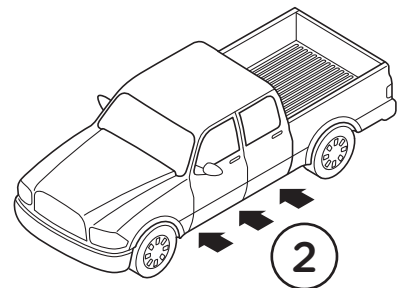

3. Remove the **Tape** covering the factory oblong hole in the rocker panel located above the two (2) hex holes.

4. Place the Plastic Push Nut onto the stud of the M12 Bolt + M10 Nut Plate (4b). Then, slide the M12 Bolt + M10 Nut Plate into the hole in the rocker panel as shown (4a).

5. Front & Center Bracket Cradle face to the rear of truck and Rear Bracket Cradle truck.

6. Begin installation on passenger side. Position Front Bracket, Center Bracket and Rear Bracket as shown along passenger side.

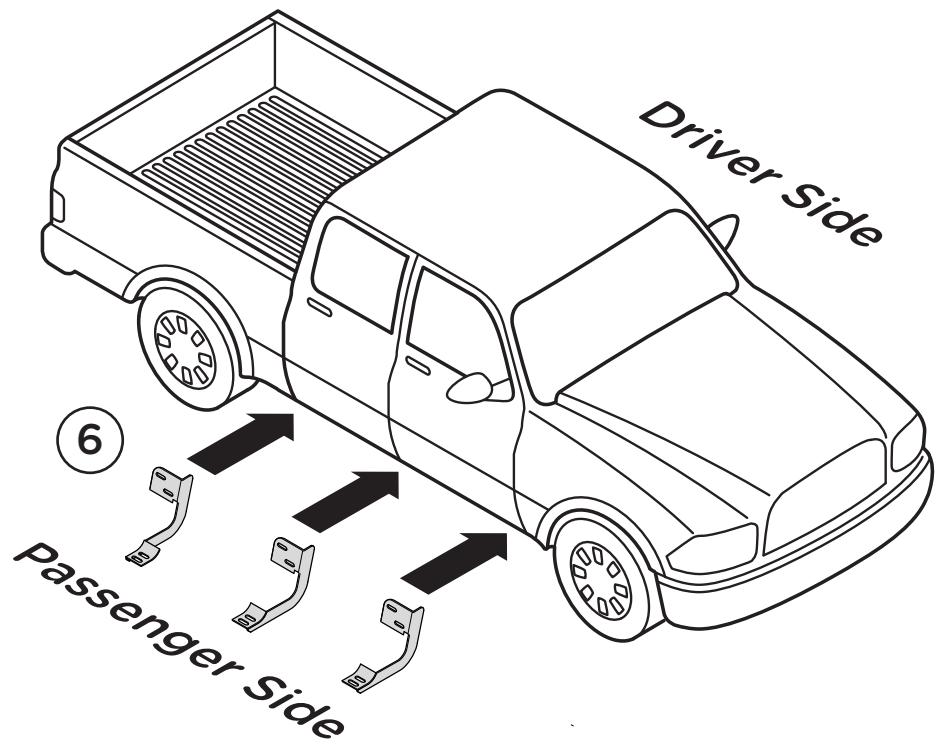
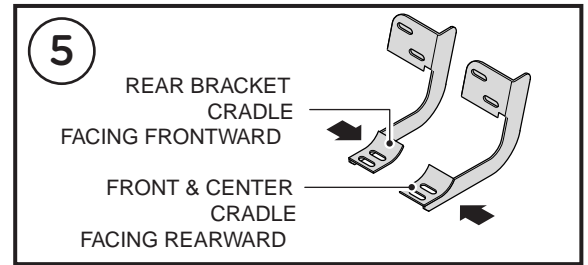
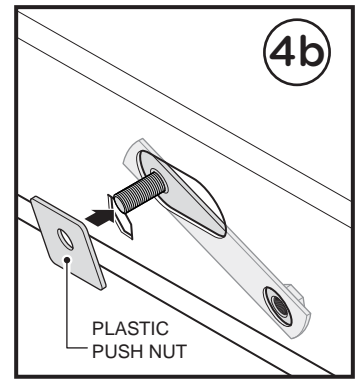
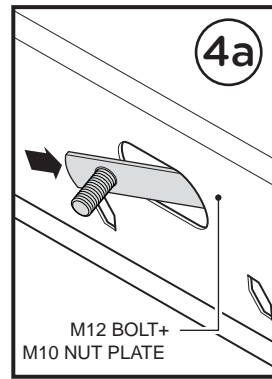
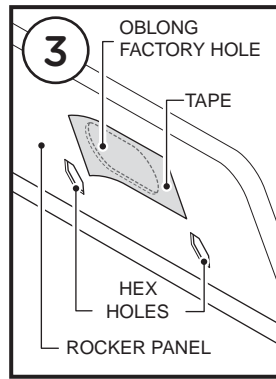

7. Line up each bracket to the 12 Bolt + M10 Nut Plate located in the rocker panel.

Fasten the Bracket onto the M12 Bolt using one (1) M12 Flat Washer, one (1) M12 Lock Washer and one (1) M12 Hex Head Nut.

Fasten the Bracket to the threaded nut using one (1) M10 Flat Washer, one (1) M10 Lock Washer and one (1) M10 x 30MM Hex Head Bolt.

If threaded inserts already exist in rocker panel holes, use (1) M8 Flat Washer, one (1) M8 Lock Washer and one (1) M8 x 40MM Hex Head Bolt.

8. Place the Rubber Gaskets onto each Bracket Cradle (8a.) Then, place the Step Bar onto the Brackets and fasten using two (2) M10 Flat Washers, two (2) M10 Lock Washers and two (2) M10 x 30MM Button Head Bolts (8b).

Tighten until the split lock washer is at against bracket and snug. **DO NOT** over tighten and strip the threaded insert in the tube.

Repeat these steps for driver side installation. When all hardware is in place, everything must be tightened. See Page 1 for Torque Specifications.

