



TRUCK STORAGE SOLUTIONS
SECURING YOUR REPUTATION

INSTALLATION MANUAL

ALUMINUM & STEEL SADDLE/CROSS BOXES

ATTENTION: PLEASE READ AND UNDERSTAND ALL INSTRUCTIONS AND WARNINGS
BEFORE ASSEMBLING, INSTALLING OR USING THIS PRODUCT.



⚠️ WARNING

*Please read page 2 before inserting
the provided keys into any of the locks.*

⚠️ NOTICE

Use specific aluminum upfit components when installing WEATHER GUARD® products to aluminum truck beds. Follow additional instructions if mounting to an aluminum truck bed. There may be left over components depending on upfit.

Any modification or unintended use of this product shall immediately void all manufacturers warranties. Manufacturer disclaims all liability for injuries to persons or property resulting from any modification to, or unintended use of this product.

⚠️ DANGER

Danger of explosion. Do not use this product for storing or transporting flammables, explosives, hazardous materials, or hazardous waste, such as containers of gasoline, solvents, gun powder, dynamite, propane tanks, acetylene tanks and cutting torches. This product is only intended and safe for use in storing and transporting small tools, equipment and other similar materials. Any modifications made to, or unintended use of this product, could create a hazardous condition that can cause death, serious personal injury or property damage.

READ AND UNDERSTAND ALL INSTRUCTIONS BEFORE INSERTING A KEY INTO THE LOCKS

This box has code-able locks installed. These locks have no pre-set key code, and only the keys provided can be used to code the locks. These locks will “learn” the code, and only the code, of the first key that the lock is coded with (see CODING THE LOCKS below).

One pair of identical keys will be provided per box.

If you have multiple boxes with code-able locks, you can:

1. Code each of the boxes with a single key. All other keys without the same code cannot be used.

OR

2. Code each box or set of boxes with their own set of keys.

Any new additional boxes with code-able locks can be coded with the keys from your original box.

Register your box and key code at weatherguard.com, and keep personal record of your key code, as there is no way to determine your key code should you lose your keys.

Extra sets of keys can be purchased by contacting one of the following:

Customer Service: 1-800-456-7865

Website: weatherguard.com

⚠ WARNING: ONCE A LOCK IS CODED IT CANNOT BE CHANGED! ⚠

CODING THE LOCKS - Easy 3-step guide

① START

Read, then remove the label, open box lid, then insert key.

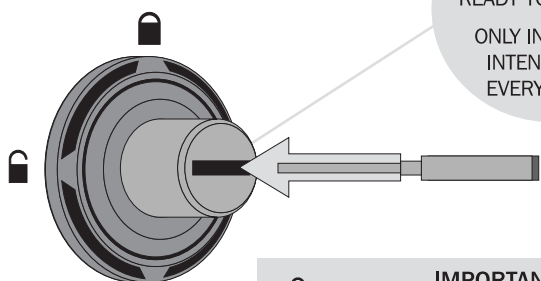

IMPORTANT:
Once a lock is coded it cannot be changed.
Make sure to register your key code

② CODING THE LOCK

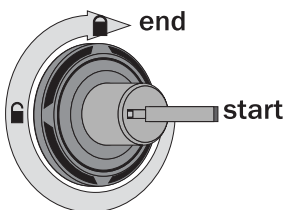

Turn key clockwise a full 3 quarters of a circle

USEFUL HITS:
When the key is coding there will be a ‘clicking’ sound
Do not stop turning the key during the coding process as this can cause issues with the lock performance

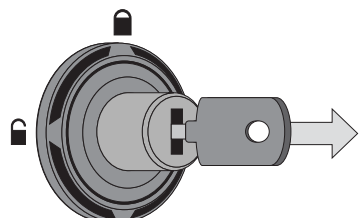

The box is now locked with the key **permanently** coded.
Remove key.

③ TESTING THE LOCK

Fully insert key again.

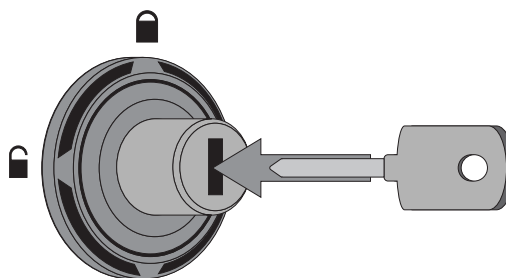

Turn key counter-clockwise 1/4 turn to unlock.

Turn key clockwise 1/4 turn to lock.

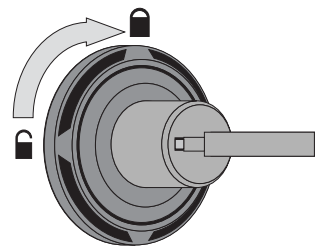
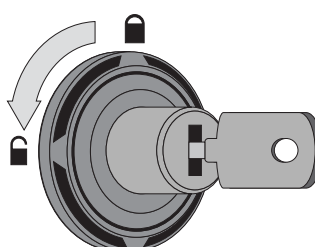

USEFUL HINT:
Lock and unlock the box 5 times to ensure it works.
Remove key fully between each test.



TOOLS REQUIRED

- Ratchet Wrench - 1/2"
- Ruler

PARTS LIST

| | | | | |
|---|--|--|--|--|
|  (2) Key |  (1) Tray | | | |
|---|--|--|--|--|

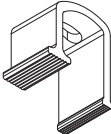
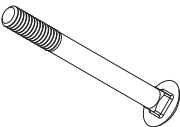
BOLT KIT

| | | | | |
|---|--|--|--|--|
|  (4) Fender Washer |  (4) Mounting Clamp |  (4) 5/16-18 x 3" Carriage Bolt |  (4) 5/16-18 Nylon Lock Nut | |
|---|--|--|--|--|

INSTALLATION INSTRUCTIONS

Note:

- If the truck is fitted with a plastic drop-in bed liner, it may need to be drilled, trimmed or cut for proper installation of truck box.
- Install boxes with vehicle parked on level ground.
- Truck box cover may not properly latch until box is fully bolted to truck bed in (4) places.
- Because truck bed configurations vary, (8) mounting slots have been provided, to ensure the use of (4) mounting clamps.
- Periodically check tightness of mounting clamps to ensure proper attachment.
- Use touch-up paint on any drill holes to prevent oxidation.

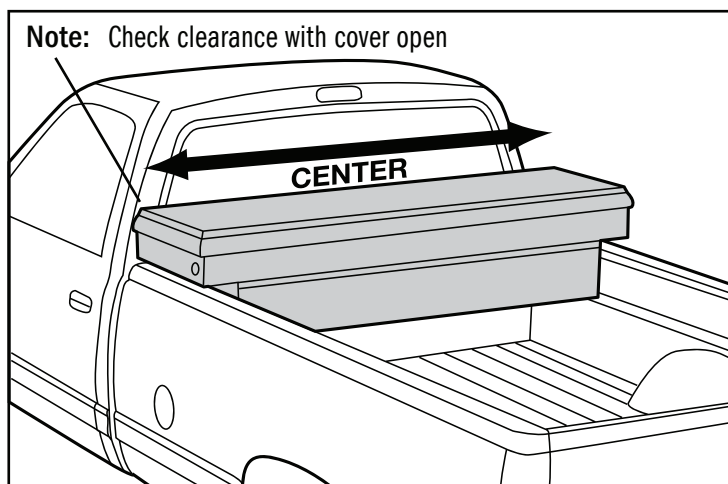

STEP 1 Locate Box in Truck Bed

Place box into position on top of the bed rails. Use ruler to ensure box is centered in truck bed and that cover opens fully without interference.

ALUMINUM TRUCK BED INSTALLATION:

If you drill holes into an aluminum truck bed to use through bolts or J-bolts, use zinc rich primer (not included) to coat the holes before assembly.

STEP 2 Attach Box to Truck Bed

Attach mounting clamps, bolts, washers and nuts as shown in figure to the right, torquing the nut to 5 ft. lbs. Start with the slot at driver side front and work clock-wise until all four clamps have been installed. One clamp should be installed in each of the 4 corners of the box for the most secure installation.

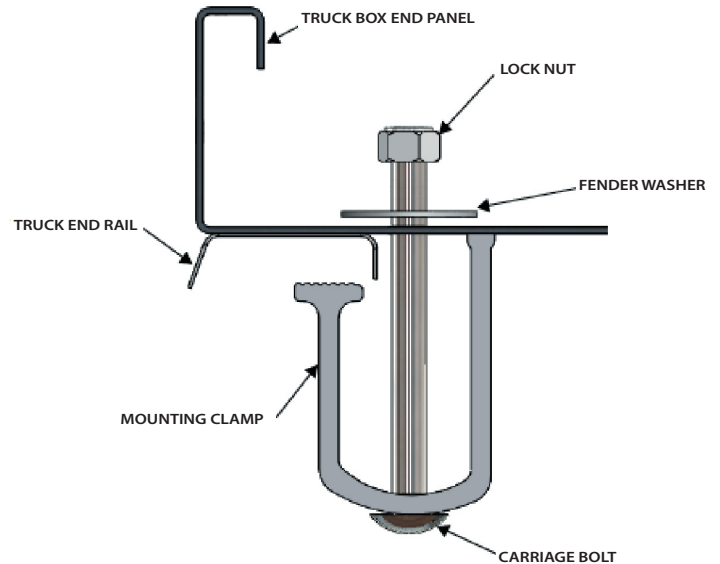

Lock System

The WEATHER GUARD® 1KEY ULTRALOCK™ Lock is designed to provide maximum security, while providing ease of use and years of reliable service. When the button is pressed in the unlock mode, the latches are activated and the cover opens.

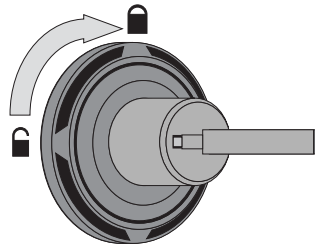

Lock

Turn the key clockwise to the locked position as indicated on the lock bezel.

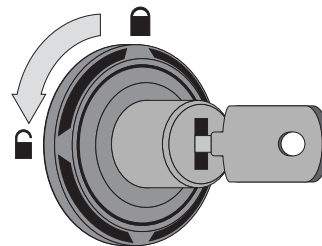

Unlock

Turn the key counter-clockwise to the unlocked position as indicated on the lock bezel. It is now ready to release the latches when pressed.

Latch System

The WEATHER GUARD® Latch System utilizes automotive grade latches in conjunction with high strength latch strikers to ensure maximum security. The WEATHER GUARD® Latch System is designed to open with a single touch of the button, and close securely. Expect years of reliable service from the WEATHER GUARD® Latch System with only minimal maintenance: Lubricate latch pivot points bi-annually with white grease. If latch strikers are accidentally knocked out of alignment, simply use a mallet to re-align.

12V Electrical Access

WEATHER GUARD® Truck Boxes are equipped with a 12 volt electrical access grommet for easy electrical accessory fit-ups. To use, simply cut along one or more perforations in the rubber grommet and run wire through.

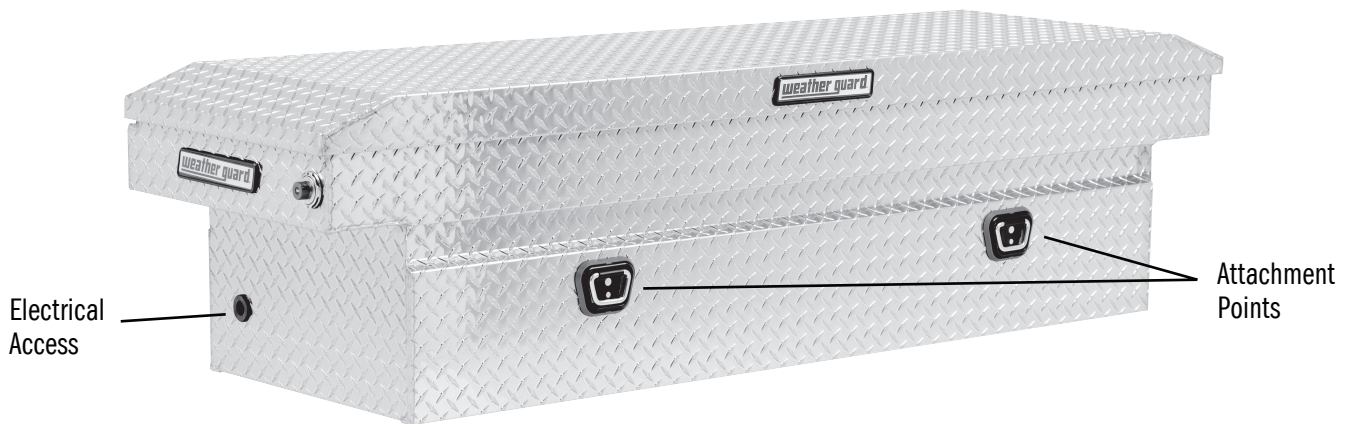

⚠ WARNING

Extension Cord

- Follow all Extension Cord manufacturer's warnings and instructions.
- DO NOT insert extension cord through hole without grommet in place.
- Only use a three-wire extension cord with all three prongs intact. Never remove the round grounding prong.
- Extension cord must be connected to a 120 Volt GFCI protected outlet with proper ground. If GFCI outlet is not available, use an extension cord with GFCI protection built in.
- Check the insulation and plugs of extension cord before using. DO NOT use cord if it is worn or damaged.
- DO NOT overload extension cord.
- Remove extension cord from the grommet hole before moving or transporting saddle/cross box.
- Only use an extension cord that is rated for outdoor use.
- DO NOT connect extension cord to outlet that also supplies critical safety equipment with power.

Cordless Power Tool Battery Chargers

- See Charger's Owner's Manual for proper use and care of charger and batteries. Follow all warnings and instructions provided with your battery charger.
- Chargers are dry location use only. DO NOT expose to liquid, vapor or rain. Should your charger become wet, DO NOT attempt to use.
- Unplug extension cord from supply before handling wet charger or cords.
- Only use chargers and batteries that are intact and operating properly.
- DO NOT touch metal prongs when plugging charger into extension cord.
- Keep flammable materials like paper or rags away from charger, cords or connections.
- DO NOT place or attempt to charge lead acid, car type batteries in saddle/ cross box.

WERNER CO. LIMITED LIFETIME WARRANTY FOR WEATHER GUARD® PRODUCTS

WEATHER GUARD® Products - Limited Lifetime Warranty

WERNER CO. (the “Manufacturer”) warrants to the original purchaser only that WEATHER GUARD® Truck and Van Products (the “WEATHER GUARD® Product”) will be free from defects in material and workmanship from the date of purchase and continuing for the expected lifetime of the WEATHER GUARD® Product. A copy of the original sales receipt must be supplied to the Manufacturer at the time a warranty claim is made. This warranty terminates if the original purchaser transfers the WEATHER GUARD® Product to any other person.

What is Covered

All WEATHER GUARD® Products identified above that are purchased on or after January 1, 2009.

What We Will Do To Correct Problems

Subject to the limitations and exclusions described in this limited warranty, the Manufacturer will remedy defects in materials or workmanship by providing one of the following remedies at its option and without charge to the original purchaser for parts or labor: (a) repairing the defective portion of the WEATHER GUARD® Product or (b) replacing the entire WEATHER GUARD® Product. In addition, the Manufacturer may elect at its option, not to repair or replace the WEATHER GUARD® Product, but rather issue to the original purchaser a refund equal to the purchase price paid for the WEATHER GUARD® Product or a credit to be used toward the purchase of a new WEATHER GUARD® Product.

What is Not Covered

This limited warranty expressly excludes:

Defects caused by normal wear and tear, cosmetic rust, scratches, accidents, unlawful vehicle operation, or modification to the product, or any types or repair of a WEATHER GUARD® Product other than those authorized or provided by the Manufacturer.

Defects resulting from conditions beyond the Manufacturer’s control including, but not limited to misuse, overloading, or failure to assemble, mount or use the WEATHER GUARD® Product in accordance with the Manufacturer’s written instructions or guidelines included with the WEATHER GUARD® Product or made available to the original purchaser.

Damage to the contents of the box or vehicle.

TO THE EXTENT PERMITTED BY LAW, IN NO EVENT SHALL THE MANUFACTURER BE LIABLE FOR ANY INCIDENTAL, SPECIAL, INDIRECT, OR CONSEQUENTIAL DAMAGES, INCLUDING ANY ECONOMIC LOSS, WHETHER RESULTING FROM NONPERFORMANCE, USE, MISUSE OR INABILITY TO USE THE WEATHER GUARD® PRODUCT OR THE MANUFACTURER’S NEGLIGENCE.

No Other Express Warranty Applies

This Limited Lifetime Warranty is the sole and exclusive warranty for WEATHER GUARD® Products. No employee, agent, dealer, or other person is authorized to alter this warranty or make any other warranty on behalf of WERNER CO.

Notification Procedures

If the WEATHER GUARD® Product does not conform with the terms of this limited warranty, the original owner must promptly notify the Manufacturer in writing upon discovery of the nonconformity. In order to receive the remedies under this limited warranty, the warranty claim must describe the nature of the nonconformity, and a copy of the original sales receipt, invoice, bill or other proof of purchase must accompany the claim. Repairs or modifications made to the WEATHER GUARD® Product by other than the Manufacturer or its authorized agent will nullify this limited warranty. Coverage under this limited warranty is conditioned at all times upon the owner’s compliance with these required notification and repair procedures. Warranty claims must include reciprocal contact information and may be made via certified mail to:

WERNER CO.
ATTN: Warranty Claims
420 E. Terra Cotta Avenue
Crystal Lake, IL 60014



If you have any questions,
please call toll free at 1-800-456-7865

WERNERCO™