

PARTS LIST:

1	Grille Guard	4	12mm Lock Washers
1	Passenger Side Mounting Bracket	4	12mm Nylon Lock Nuts
1	Driver Side Mounting Bracket	2	10-1.50mm x 25mm Button Head Bolts GR 10.9
1	Passenger Side Top Bracket for Titan and 04-07 Armada	4	10mm x 20mm OD x 2mm Flat Washers
1	Driver Side Top Bracket for Titan and 04-07 Armada	2	10mm Nylon Lock Nuts
1	Passenger Side Top Bracket for 08 Armada	2	8-1.25mm x 35mm Hex Bolts
1	Driver Side Top Bracket for 08 Armada	4	8mm x 16mm OD x 1.6mm Flat Washers
4	12-1.25mm x 45mm Fine Thread Hex Bolts GR 10.9	2	8mm Nylon Lock Nuts
4	12-1.75mm x 35mm Hex Bolts	2	2" x 1-1/4" Adhesive Foam Strips
4	12mm x 32mm OD x 3mm Large Flat Washers	1	6mm Allen Wrench
8	12mm x 24mm OD STD Flat Washers		

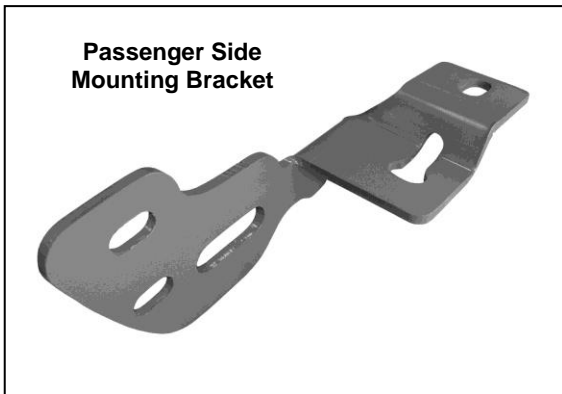

PROCEDURE:

1. **REMOVE CONTENTS FROM BOX. VERIFY ALL PARTS ARE PRESENT. READ INSTRUCTIONS CAREFULLY. ASSISTANCE IS RECOMMENDED.**
2. If vehicle is equipped with factory tow hooks, remove the hex bolts and tow hooks, **(Figure 1)**.
 - a. **Titan PRO 4X (and all models with factory skid plate):** Remove the skid plate to get to the tow hooks by removing the four Torx bolts in the front, **(Figure 2)**, and the two hex bolts holding the factory skid plate toward the rear and any other hardware, **(Figure 3)**. Next remove the tow hooks and skid plate mounting brackets from vehicle.
3. Select the driver side Mounting Bracket and position it onto frame. Reinstall the driver side tow hook, (if equipped), over the Mounting Bracket, **(Figures 4 & 5)**.
 - a. **Titan PRO 4X (and all models with factory skid plate):** Reinstall the skid plate mounting bracket and re-attach it to the frame using the factory tow hook bolts, **(Figures 4 & 5)**.
 - b. **Vehicle without factory tow hooks:** Use the included (2) 12-1.25mm x 45mm **Fine Thread** Hex Bolts, (2) 12mm Lock Washers and (2) 12mm x 32mm Large Flat Washers to attach Mounting Bracket to frame, **(Figure 6)**.
4. Do not tighten hardware at this time. Repeat **Step 3** for passenger side Bracket installation.
5. Open the hood and remove the factory grille shell from the vehicle. **NOTE:** Carefully squeeze the plastic clips holding the grille shell in place to release. Once clips are released and top clips removed, carefully pull on grille shell to remove it, **(Figures 7A & 7B)**.
6. **Very important:** Determine correct Top Bracket and apply foam strips to the bottom and top surface of the Bracket to protect the finish of the bumper and grille shell, **(Figure 8)**.
 - a. **08-on Armada:** There are two plastic fasteners on each side of the top inside of the bumper. Remove the outer plastic fastener on each side, (the fastener closer to the headlight). Attach driver side Top Bracket to bumper using the included (1) 8mm x 35mm Hex Bolt, (2) 8mm Flat Washers and (1) 8mm Nylon Lock Nut, **(Figure 9)**. Do not tighten hardware at this time.
 - b. **All Titan & up to 07 Armada:** Remove the two factory bolts located on the top inside of the bumper. Attach Top Brackets using the existing bolts, **(Figure 10)**. Do not tighten at this time.
7. Repeat **Step 6** for passenger side Top Bracket installation.
8. Re-install the factory grille shell. **NOTE:** To make reinstallation easier, first reattach the fasteners to the back of the grille, **(Figure 11)**. Hold the grille in place and align the fasteners with the original mounting holes. Carefully push the grille into position. Reinstall all factory hardware.
9. With help, position the Grille Guard onto the outside of the Frame Mounting Brackets. Attach the Grille Guard to the Mounting Brackets with the included (4) 12-1.75mm x 35mm Hex Bolts, (8) 12mm x 24mm STD Flat Washers and (4) 12mm Nylon Lock Nuts, **(Figure 12)**. Do not tighten at this time.
10. Attach the Top Brackets to the Grille Guard with the included (2) 10-1.5mm x 25mm Button Head Bolts, (4) 10mm Flat Washers and (2) 10mm Nylon Lock Nuts, **(Figure 13)**. Do not tighten at this time.
11. Level and adjust the Grille Guard and tighten all hardware at this time including all Top Bracket and Support Bracket hardware.
12. **For PRO 4X** and other models with factory skid plate, reinstall the skid plate using the factory hardware. Tighten all skid plate hardware.
13. Do periodic inspections to the installation to make sure that all hardware is secure and tight.

To protect your investment, wax this product after installing. Regular waxing is recommended to add a protective layer over the finish. Do not use any type of polish or wax that may contain abrasives that could damage the finish.

For stainless steel: Aluminum polish may be used to polish small scratches and scuffs on the finish. Mild soap may be used also to clean the Grille Guard.

For gloss black finishes: Mild soap may be used to clean the Grille Guard.

Driver side installation pictured

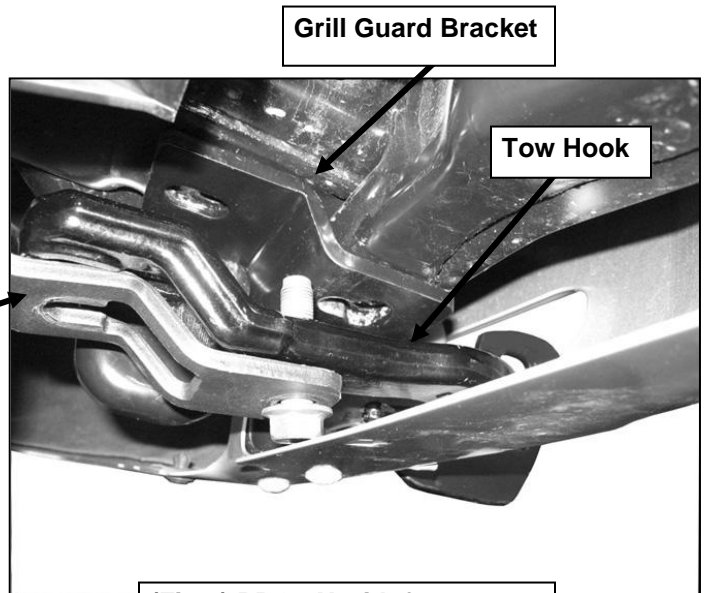
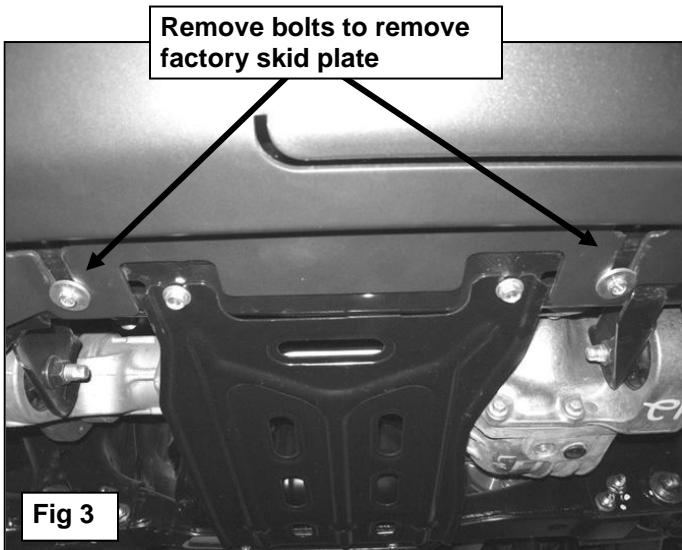
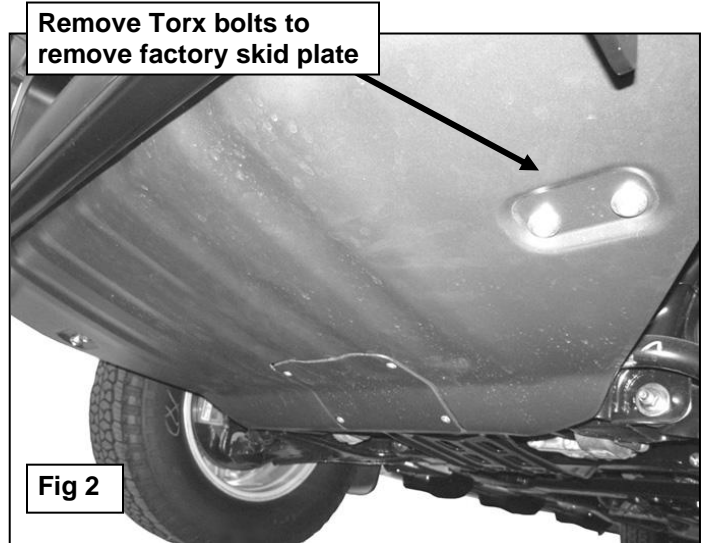
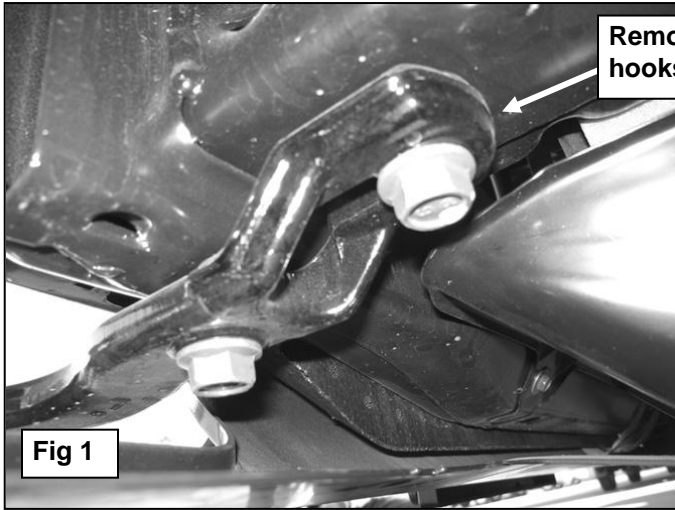

(Fig 4) PRO 4X with factory skid plate pictured (removed)

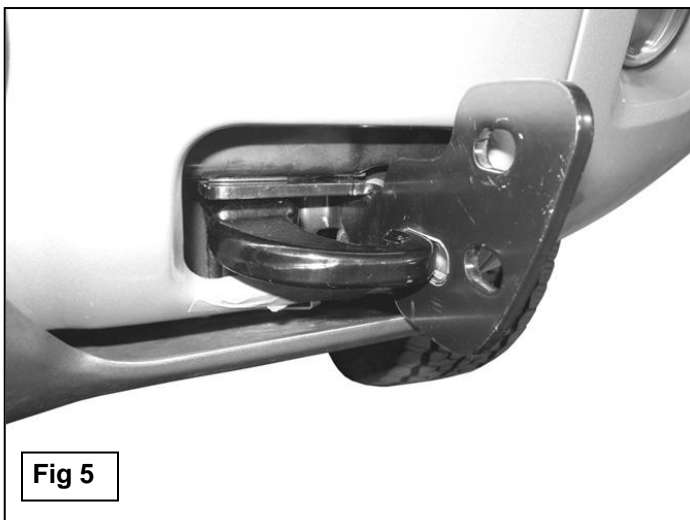



12-1.25mm x 45mm Fine Thread
Hex Bolts
12mm Lock Washers
12mm x 32mm Large Flat Washers

(Fig 6) Driver side pictured-models without tow hooks

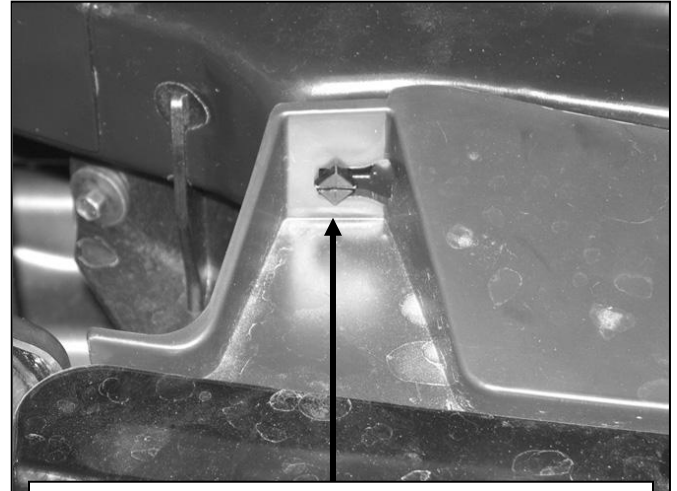

(Fig 7A) Top fastener on grille insert pictured

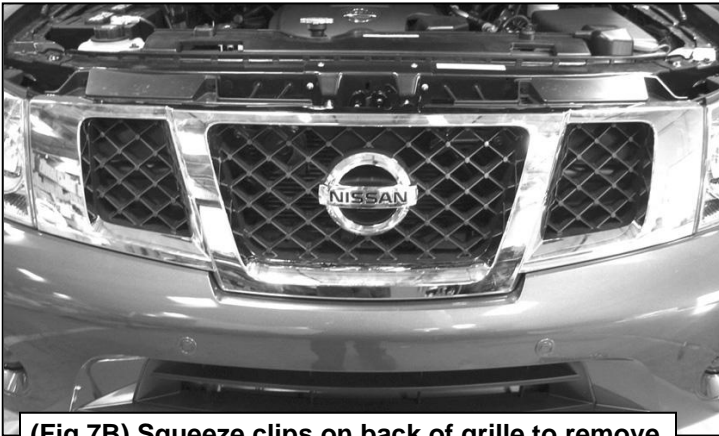

(Fig 7B) Squeeze clips on back of grille to remove

Place adhesive foam here
to protect bumper cover

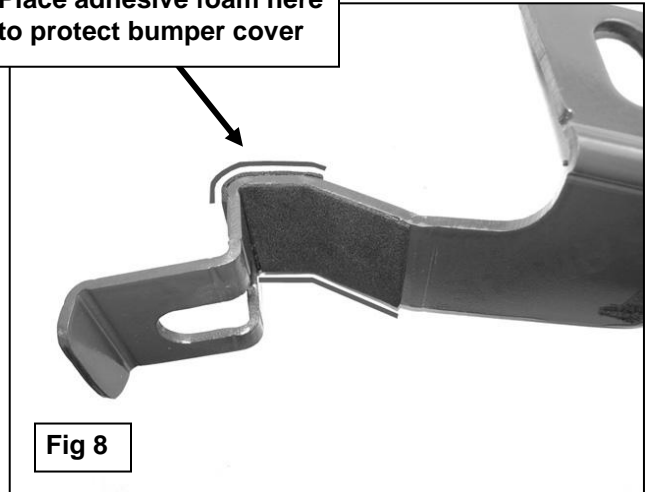
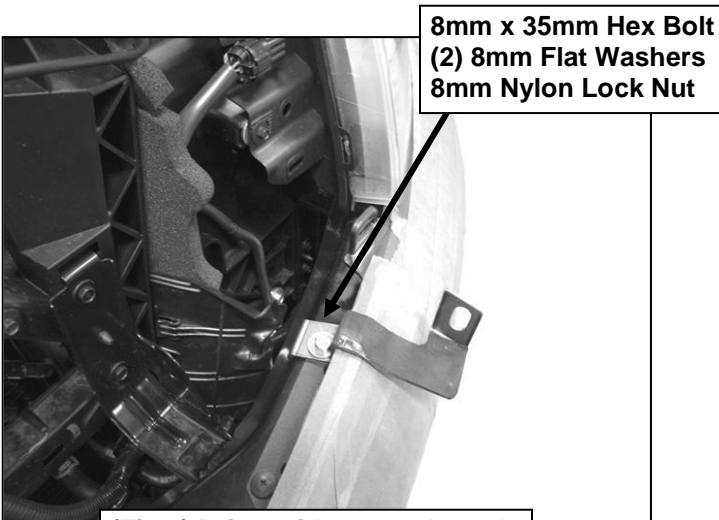

Fig 8

Passenger side 08-up Armada
Top Bracket pictured



8mm x 35mm Hex Bolt
(2) 8mm Flat Washers
8mm Nylon Lock Nut

(Fig 9) Driver side 08-up Armada
Top Bracket pictured



Line bottom of Bracket
with foam tape

Fig 10

Titan & 04-07 Armada. Use Factory
Hex Bolts to install Top Bracket

- (2) 12mm x 35mm Hex Bolts
- (4) 12mm Flat Washers
- (2) 12mm Nylon Lock Nuts

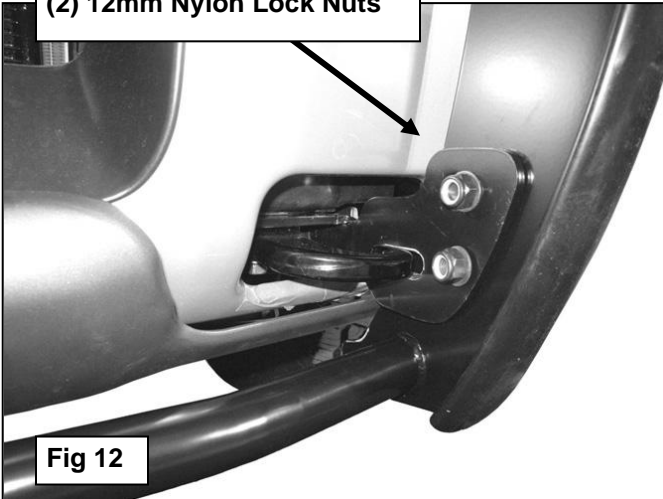
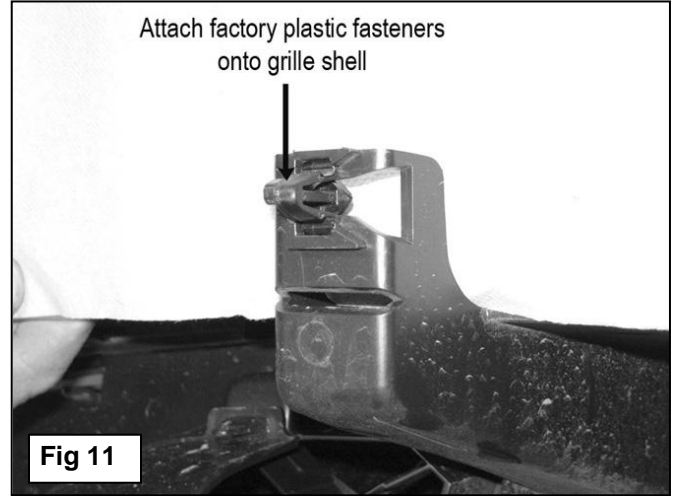

Fig 12



Attach factory plastic fasteners
onto grille shell

Fig 11

- 10mm x 25mm Button Head Bolt
- (2) 10mm Flat Washers
- 10mm Nylon Lock Nut



Fig 13

Titan & 04-07 Armada pictured without
grille for photo purposes only. Reinstall
grille before attaching Grille Guard



Installation Complete