

PARTS LIST:

1	Extreme Grille Guard	6	12mm Lock Washers
1	Driver/Left Frame Mounting Bracket	6	12mm Hex Nuts
1	Passenger/Right Frame Mounting Bracket	8	10-1.5mm x 45mm Gr. 10.9 Hex Bolts
1	Driver/Left Lower Mounting Bracket	16	10mm x 27mm OD x 3mm Flat Washers
1	Passenger/Right Lower Mounting Bracket	8	10mm Lock Washers
6	12-1.75mm x 40mm Gr. 10.9 Hex Bolts	8	10mm Hex Nuts
12	12mm x 32mm OD x 3mm Flat Washers		



PROCEDURE:

- 1. REMOVE CONTENTS FROM BOX. VERIFY ALL PARTS ARE PRESENT. READ INSTRUCTIONS CAREFULLY BEFORE STARTING INSTALLATION. ASSISTANCE IS RECOMMENDED. CUTTING IS REQUIRED.**
- Starting under the front bumper, carefully remove the plastic splash guard from the bottom of the bumper. Depending on the model of truck, the splash guard may be attached to the bumper with hex bolts and several two-piece plastic push-in clips. First, remove all hex bolts, then locate the clips behind and across the front of the bumper, **(Figure 1A)**. Pry up on the center pin of the clip with a flat blade screwdriver to release the pin then remove the entire clip, **(Figure 1B)**. **NOTE:** Pay close attention to the type and location of all factory hardware for reinstallation. Move the splash guard to a clean stable work area.
- Remove the driver side tow hook, **(Figure 2)**. **NOTE:** The factory hex bolts and nuts securing the inner (2) tow hook bolts may be difficult to remove. Assistance is recommended. Use a socket with a long extension to reach the hex nuts on the inner tow hook bolts. Once the tow hook has been removed, **(Figure 3)**, select the driver side Frame Bracket and place it between the tow hook and the frame. Secure the tow hook and Frame Bracket to the vehicle with (4) 10mm x 45mm Hex Bolts, (8) 10mm Flat Washers, (4) 10mm Lock Washers and (4) 10mm Hex Nuts, **(Figure 4)**. Snug but do not tighten hardware at this time.
- Select the driver side Lower Mounting Bracket. Remove the (2) factory hex nuts securing the lower part of the bumper to the bumper bracket. Line up the mounting hole and slot in the Bracket with the (2) bumper bolts and secure with the factory hex nuts, **(Figure 5)**. Snug but do not tighten hardware at this time. Repeat Step 3 – 4 for passenger side Mounting Bracket installation.

**EXTREME GRILLE GUARD
2010 DODGE RAM 2500-3500**

5. Hold the plastic splash guard up in the approximate position. Mark the areas indicated onto the driver and passenger side of the splashguard, **(Figure 6)**. Cut out (2) openings for the lower Mounting Brackets, **(Figure 7)**. Reinstall the splash guard using the factory hardware.
6. With assistance, position the Grille Guard up to the Frame Mounting Brackets. Use the included (4) 12mm x 40mm Hex Bolts, (8) 12mm Flat Washer, (4) 12mm Lock Washers and (4) 12mm Hex Nuts to attach the Grille Guard to the Frame Mounting Brackets, **(Figure 8)**. Insert the lower tabs on the Grille Guard through the openings cut into the splash guard in **Step 5**. Trim plastic as necessary to properly clear brackets. Snug but do not tighten hardware at this time.
7. Line up the holes and attach the Grille Guard to the Lower Mounting Brackets using the included (2) 12mm x 40mm Hex Bolts, (4) 12mm Flat Washers, (2) 12mm Lock Washers and (2) 12mm Hex Nuts, **(Figure 9)**. Snug but do not tighten at this time.
8. With assistance, align and adjust the Grille Guard and tighten all hardware. **IMPORTANT:** Do not allow the Frame Mounting Brackets to contact the bumper. Align the Frame Mounting Brackets so that they are centered, side-to-side and that there is an even gap between the Brackets and the steel bumper.
9. Do periodic inspections to the installation to make sure that all hardware is secure and tight.

To protect your investment, wax this product after installing. Regular waxing is recommended to add a protective layer over the finish. Do not use any type of polish or wax that may contain abrasives that could damage the finish.

For stainless steel: Aluminum polish may be used to polish small scratches and scuffs on the finish. Mild soap may be used also to clean the Grille Guard.

For gloss black finishes: Mild soap may be used to clean the Grille Guard

Driver Side Installation Pictured

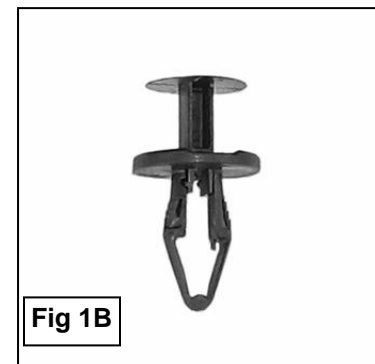
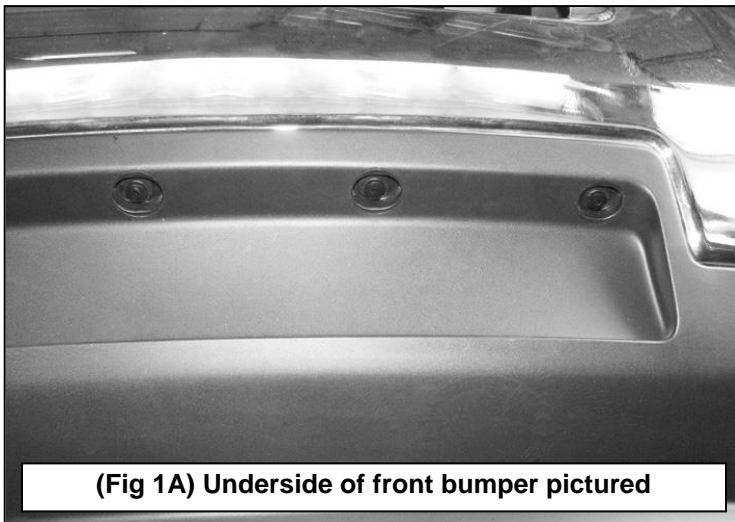

**Pictured for example only,
actual clip may differ**

Driver Side Installation Pictured



- (4) 10mm x 45mm Hex Bolts
- (8) 10mm Flat Washers
- (4) 10mm Lock Washers
- (4) 10mm Hex Nuts

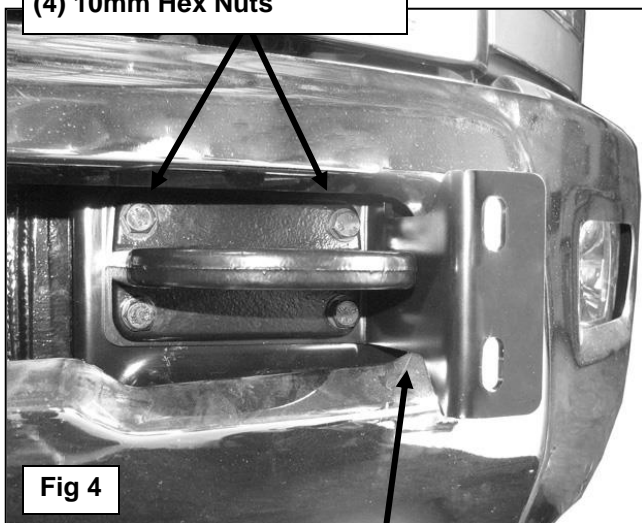

IMPORANT: To prevent damage to the bumper and/or Frame Mounting Brackets, do not allow the Brackets to come in contact, top or bottom, with the steel bumper

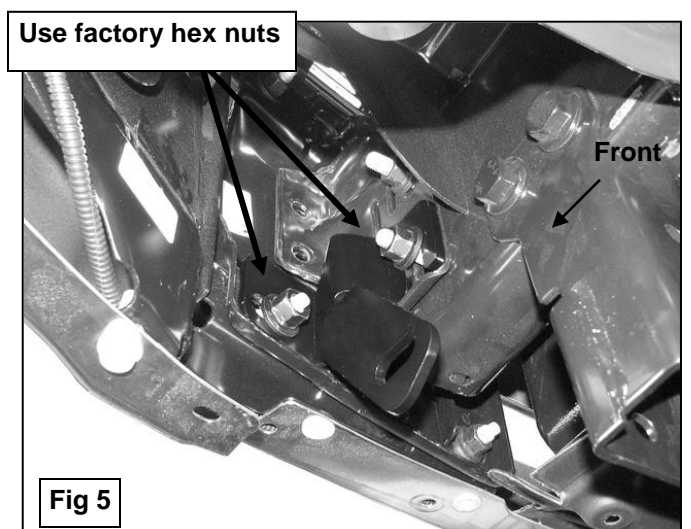

**EXTREME GRILLE GUARD
2010 DODGE RAM 2500-3500**

Driver Side Installation Pictured

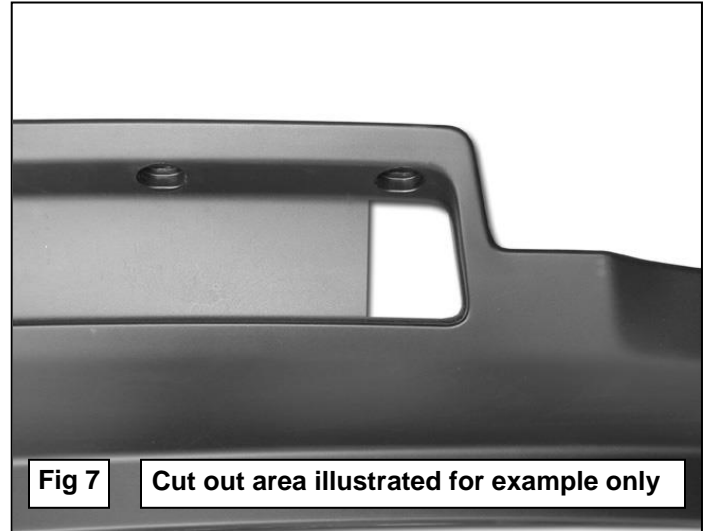
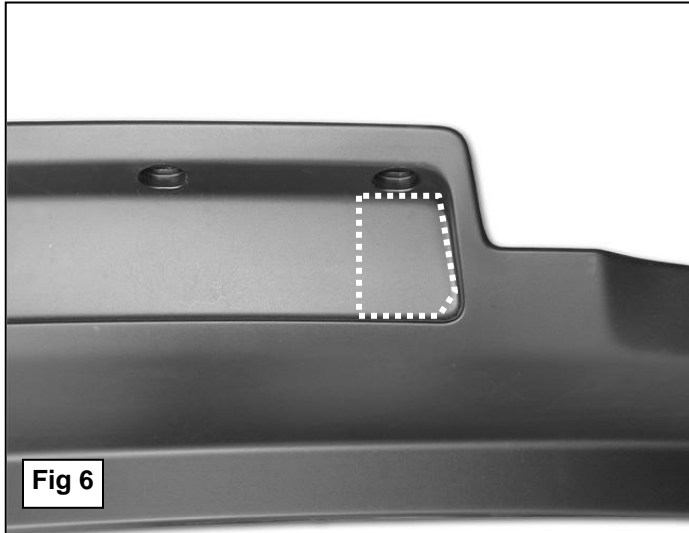

**12mm x 40mm Hex Bolt
(2) 12mm Flat Washers
12mm Lock Washer
12mm Hex Nut**

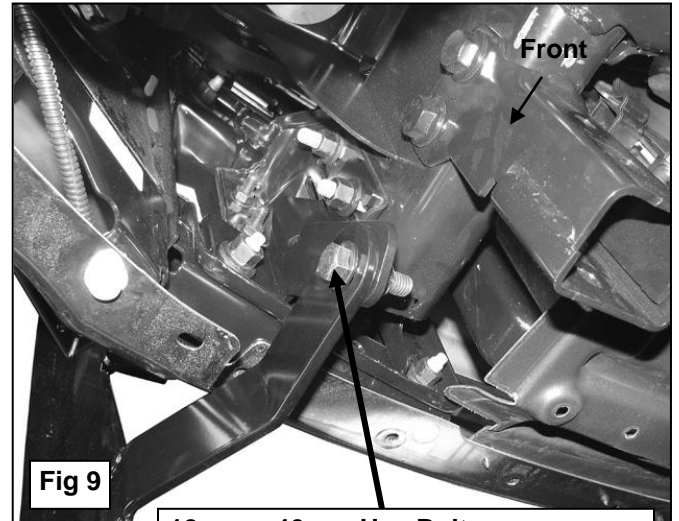
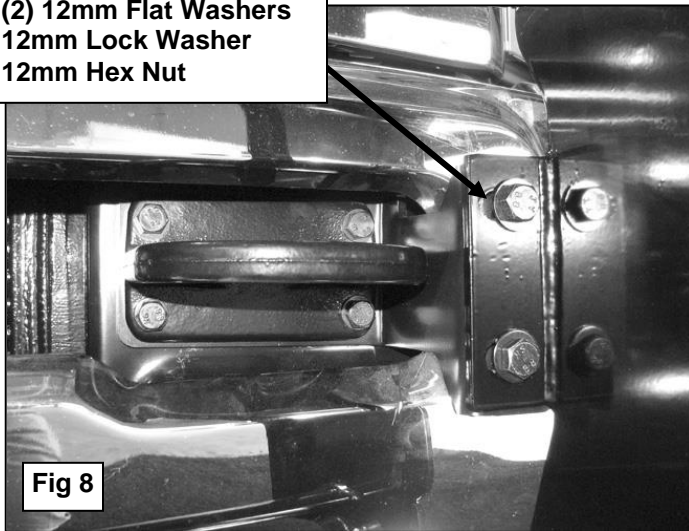

**12mm x 40mm Hex Bolt
(2) 12mm Flat Washers
12mm Lock Washer
12mm Hex Nut
(Pictured from below without splash guard for illustration purposes only)**

