



## INSTALLATION INSTRUCTIONS

### VEHICLE APPLICATION

Year: **2010 - 2012**  
 Make: **Dodge RAM**  
 Model: **2500/3500**  
 Engine: **6.7L Cummins**

### TOOLS REQUIRED

- 7mm Wrench or Socket
- 8mm Wrench or Socket
- 10mm Wrench or Socket
- 7/16" Wrench or Socket
- 5/16" Nut Driver or Flat Blade Screwdriver
- Phillips Screwdriver, Pliers or Channel locks

### S&B FILTER MAINTENANCE

- Cleanable (**KF-1053**). If the enclosed filter is Red, it came pre-oiled from the factory. Please visit [www.sbfilters.com](http://www.sbfilters.com) for the exact oil amount required after cleaning.
- Disposable (**KF-1053D**). If the enclosed filter is White, it is a disposable filter and should be discarded once it reaches capacity. This filter (**does not require oil**). For more info on S&B's disposable filter, visit [www.sbfilters.com](http://www.sbfilters.com).

### NOTES

Kit may not fit with the following Aftermarket Parts installed:

- Body Lift or Lowering Kit
- Custom Hood
- Intercooler or Turbo upgrades

### CARB STATUS - Pending

Product will be submitted to Air Resources Board for approval shortly.

**Not legal for use in CA or other states adopting CA emissions standards See Page 3 for more info.**

### BEFORE YOU START

- Please read the entire product guide before proceeding.
- Ensure all components listed on page 5 are present.
- If you are missing any of the components, call our customer support at (909) 947-0015.
- Do not work on your vehicle while engine is hot.
- Make sure the engine is turned off and the vehicle is in Park or the Parking Brake is set.

1. With the ignition switched off and the parking brake set, disconnect the negative battery cables on both batteries.

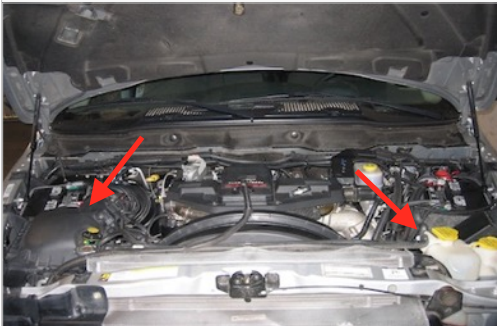

2. Disconnect the electrical harness connectors for the Intake Air Temp (IAT) and the Mass Air Flow (MAF) sensor then unsnap the wire loom from the tube. On the MAF sensor, slide the red locking tab up then press down on the tab and pull the connector out. For the IAT sensor, press down on the grey tab and pull the connector out.

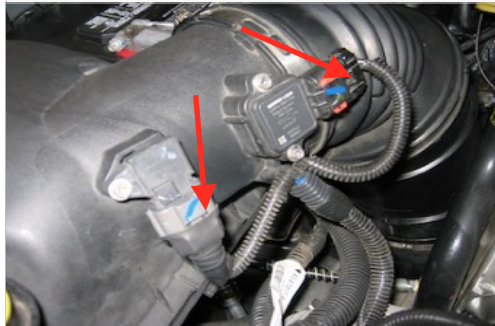

3. Loosen the hose clamp at the turbo inlet, next pinch the spring clamp and slide it up the CCV line. Pull off the silicone hose and remove spring clamp.

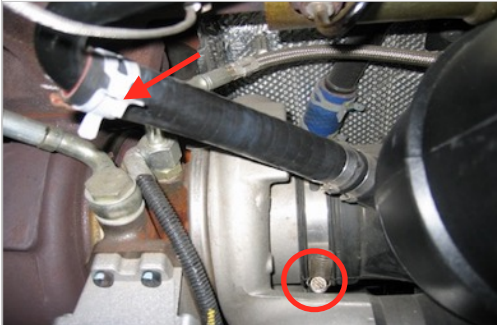

4. Remove the mounting nut on the core support securing the stock air box.



5. Lift up and out to remove the stock air box assembly from the vehicle.



6. Remove the plastic clip holding the coolant overflow tube to the fender. Remove the clip from the tube and rest the tube on the air inlet foam.



7. Carefully remove both MAF and IAT sensors from the stock air tube. Use the supplied Screws (E), MAF Gasket (V), IAT Sensor Spacer (U), and IAT Sensor Gasket (T) to install the sensors onto the Air Intake Tube (C). Do not over tighten.

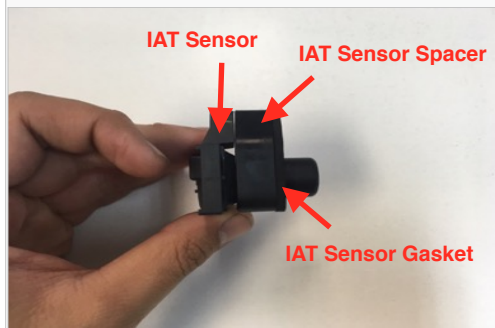

**SEE EXPLODED VIEW ON PAGE 4**



## INSTALLATION INSTRUCTIONS (CONTINUED)

8. Install the Tube Seal (B) onto the Air Box (A).



9. For those concerned about minimal engine heat; install the Box Plug (H) into the bottom of the Air Box (A) using the provided Screws (L), Lock Washers (K) and Flat Washers (J). For those seeking additional air flow, set the box plug aside.

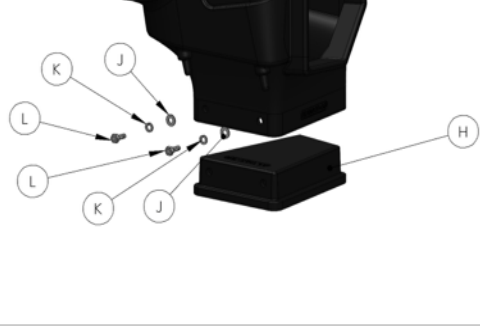

10. Slide the Coupler (G) and both #64 Hose Clamps (Q) onto the turbo as shown below. Tighten the clamp by the turbo. Leave the other clamp loose for now.



11. Place the Air Filter (D) and Air Box (A) into the truck.



12. Install the Air Intake Tube (C) onto the turbo and slide the Breather Hose (I) onto the CCV line with the two #12 Hose Clamps (R) and spout on the air intake tube. Insert the other end of the air intake tube into the Air Box (A). You may have to lift the air box up a little bit to get the air intake tube through the Tube Seal (B). Tighten the hose clamp at the turbo and two hose clamp for the breather hose. Align the box prongs on the bottom of the air box with the grommets on the side of battery tray and push down on the box to completely seat the prongs onto the grommet.



13. Use the supplied Allen Head Screw (F) to secure the Air Box (A).



14. Install the Air Filter (D) onto the Intake Tube (C) with the provided #88 Hose Clamp (S). Tighten the hose clamp.

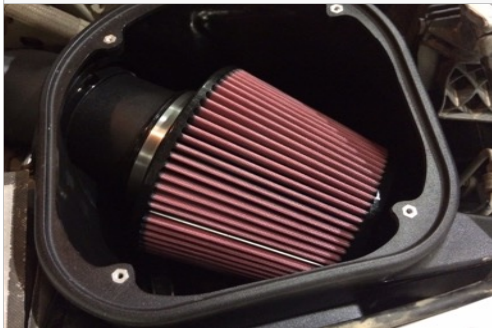

15. Reconnect the MAF and IAT electrical harness connectors. If necessary, zip tie the harness away from any engine components generating too much heat.



16. Remove the protective covering on the Clear Lid (M) and the install the Edge Trim (N).



17. Place the Clear Lid (M) on top of the Air Box (A) using the supplied Screws (P) and Washers (O).



18. Reconnect the negative terminal on both batteries. Inspect your installation, make sure the kit is properly positioned and all fasteners are secure. Affix the ID label near the intake kit. The installation is now complete.



SEE EXPLODED VIEW ON PAGE 4

## INSTALLATION INSTRUCTIONS (CONTINUED)

### RELATED ITEMS FOR YOUR PURCHASE



Air Filter Wrap  
SKU# WF-1032



Replacement Cotton Filter  
SKU# KF-1053



Replacement Dry Filter  
SKU# KF-1053D

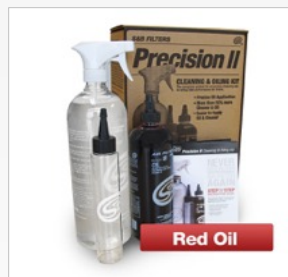

Precision II: Cleaning & Oil Kit  
SKU# 88-0008



Cold Air Intake Scoop  
SKU# AS-1002

Order online today at [www.sbfilters.com](http://www.sbfilters.com) or through your local S&B distributor.

### AIR BOX END CAP TESTING

Stock air boxes are a significant contributor to poor air flow which is why S&B designs custom air boxes with secondary and/or enlarged openings. With that said, S&B recognizes the benefits of cooler air, so we have included a plug to seal off the opening if so desired. For optimal performance, we recommend that the intake be used without the end cap except in conditions of extreme heat.

### PERFORMANCE TESTING

- Engage parking brake and start your engine. Listen for abnormal noises. If an air leak is detected, re-inspect hoses and connections as they may need to be repositioned and tightened.
- S&B FILTERS recommends that you keep your OE intake system in the event it is required in the future.
- In order to maintain your warranty, all connections and components must be checked periodically for alignment and for proper tension on all connections. Failure to do so may void your warranty.
- Use only S&B FILTERS cleaning and oil products to service your filter. Using any other brand oil and or cleaners on your S&B air filter may void your warranty.

### WARNING!

If your vehicle has a Vehicle Emission Control Information decal affixed to the factory airbox, a new replacement label must be obtained and installed in a readily visible position in the engine compartment in order to remain CARB compliant. Failure to do so will prevent the vehicle from passing a smog check. Replacement labels can be ordered from your local dealership. Regulations state that the VECI label shall not be affixed to any equipment which is easily detached from the vehicle. Label placement, under the hood on a painted surface is recommended.



### EMISSIONS STANDARD

The California Air Resource Board (CARB) requires that an E.O. identification label be applied to the vehicle in order to pass a smog check inspection when a Performance Intake Kit has been installed. You must place the E.O. label provided on or near the intake kit after installation so that a smog check technician can easily verify the E.O. number. As of April 2009, S&B has never had a product where CARB denied an exemption request; however, the exemption process with CARB can take as long as 18 months. Check the status of the exemption process by looking up a specific part number at [www.sbfilters.com](http://www.sbfilters.com). The CARB Exemption number and/or status is listed under the Product Details section for each part number. If the status shows as "Pending," CARB has yet to issue an exemption. Products that have not been issued an EO number are street legal in most states, but may not be used on emission controlled vehicles in the state of California and are for off road use only. If you purchased your kit from S&B Filters directly, we will automatically mail you your Exemption Sticker when it is issued to us. If you purchased your kit from an authorized S&B Filters Dealer, log onto our web site and register to receive your Exemption Sticker.

SEE EXPLODED VIEW ON PAGE 4



**EXPLODED VIEW**

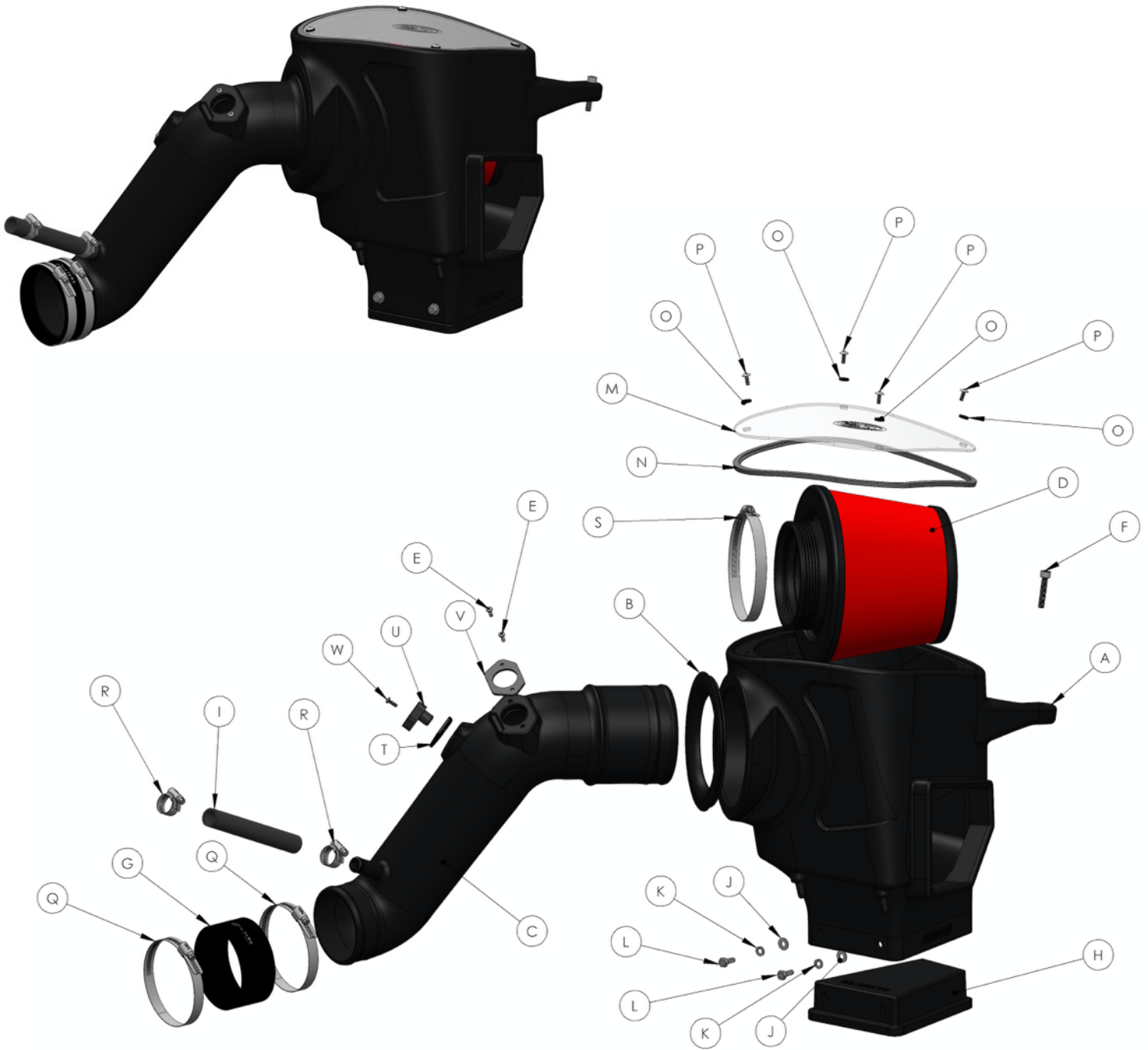

ITEM	QTY.	DESCRIPTION	P/N	ITEM	QTY.	DESCRIPTION	P/N
A	1	AIR BOX	AL1264B-00	O	4	WASHER, SEALING	AI1540-00
B	1	TUBE SEAL	AI1717C-00	P	4	SCREW, 10-24 X 1/2	AI1539-00
C	1	AIR INTAKE TUBE	AL1269-00	Q	2	HOSE CLAMP, #64	AI1018-00
D	1	AIR FILTER	KF-1053	R	2	HOSE CLAMP, #12	AG1030-00
E	2	SCREW, SS, 8-32 X 1/2	AI1479-00	S	1	HOSE CLAMP, #88	AG1011-00
F	1	SCREW, ALLEN HEAD	AI1369-00	T	1	IAT SENSOR GASKET	AI1954-00
G	1	COUPLER	AI1354C-00	U	1	IAT SENSOR SPACER	AI1955-00
H	1	BOX PLUG	AL1163-00	V	1	MAF SENSOR GASKET	AI1301-00
I	1	BREATHING HOSE	AI1040-00	W	1	SCREW, 8-32 X 1	AI1976-00
J	2	WASHER, FLAT 1/4-20	AI1073-00				
K	2	WASHER, LOCK 1/4-20	AI1309-00				
L	2	BOLT, HEX	AI1068-00				
M	1	LID	AI1613-00				
N	1	EDGE TRIM	AI1636-01				

AM0310-00 REV. C 02/17/2017