



## 2016-ON TOYOTA TACOMA INSTALLATION INSTRUCTIONS

Thank you for purchasing this set of two ROCKSTAR™ Splash Guard Mud Flaps. Agri-Cover, Inc. proudly manufactured these mud flaps using superior quality materials and workmanship. With proper care, your mud flaps will provide years of service and enjoyment.

**NOTICE TO INSTALLER:** Even if familiar with mud flaps, read instructions prior to installation as improvements may be made without notice. Always handle components with care. If you have questions or problems, call customer service. When done, these instructions must be given to the consumer.

**NOTICE TO CONSUMER:** Before using this product, read safety and maintenance section of these instructions. Save these instructions for future reference.

### FOR YOUR RECORDS

DATE PURCHASED: \_\_\_\_\_

WHERE PURCHASED: \_\_\_\_\_



Questions? 888-568-3709  
agricover.com

# PREPARATION

Unpack set of two mud flaps with components. Clean vehicle wheel wells. For additional installation assistance, go to [rockstarmudflaps.com](http://rockstarmudflaps.com) for install video.

## MUD FLAP COMPONENTS

- (2) Mud flaps
- (2) #10 x 1-1/4" Self-drilling hex screws
- (2) #10 x 1/2" Washers
- (2) Nylon hex nuts
- (6) #14 x 1-1/4" Phillips head hex screws

## TOOLS NEEDED

- Power drill/screwdriver
- #3 Phillips screwdriver
- 5/16 socket and 10 mm socket
- Protective eyewear

**NOTE:** Hardware components and appearance may vary.

**⚠ CAUTION:** These instructions involve drilling holes. Ensure all mounting hole sides are free of wiring, mechanical parts and are structurally sound.

## PARTS & FASTENER MOUNTING DIAGRAM

**NOTE:** Mud flaps may be purchased with or without pre-installed trim plates (not pictured). Trim plates are also available for purchase as an accessory.

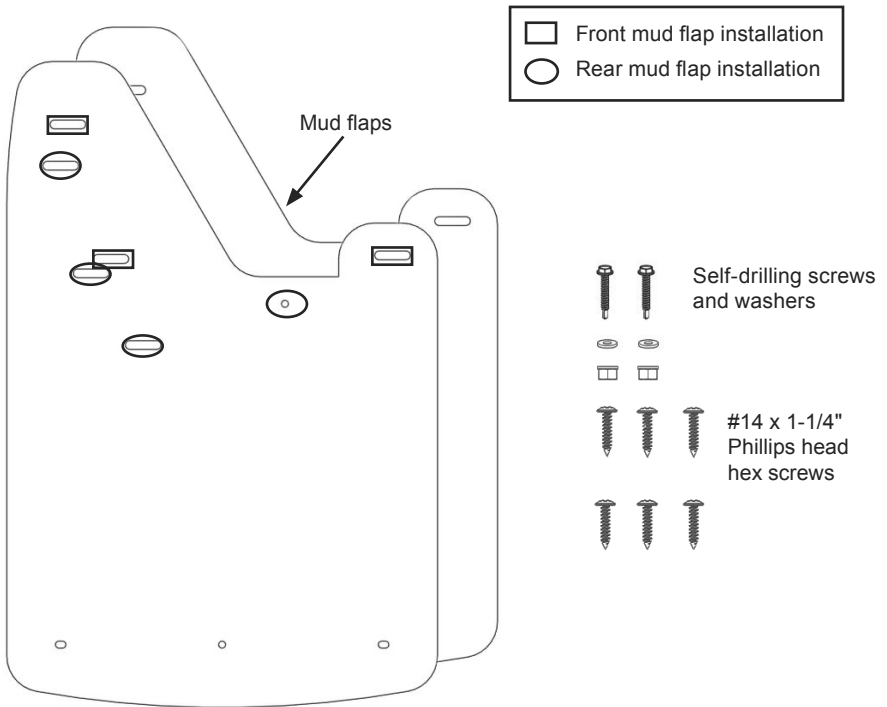

# 1: PREPARING FOR INSTALLATION

A. Park on level ground with firm surface.

B. Check free space behind front tires when fully turned. Ensure enough space and clearance to accommodate 5/16" thick mud flaps.



**NOTE:** If trim plates are pre-installed, face them toward tailgate during installation.

C. To install mud flaps, perform one of the following:

- See Step 2 for front wheel well installation
- See Step 3 (page 5) for rear wheel well installation

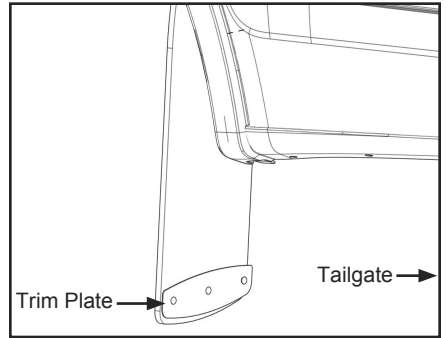

## 2: INSTALLING MUD FLAPS TO FRONT

**NOTE:** Front mud flap installation uses 3 holes per mud flap, see PARTS DIAGRAM (page 2) for locations.

A. Use 10 mm socket or Phillips screwdriver to remove lower factory screws indicated in adjacent image.

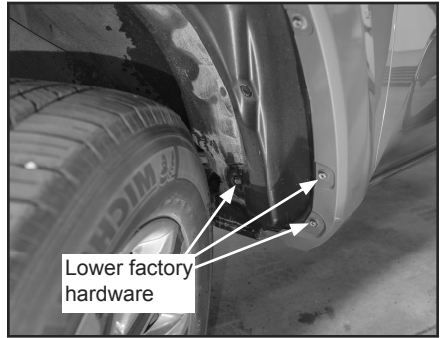

B. Install mud flaps with (3) #14 x 1-1/4" Phillips head hex screws through 1<sup>st</sup>, 3<sup>rd</sup> and inner most slotted holes into newly free holes in wheel well. Leave screws loose for now.

C. Level mud flap while adjusting placement to obtain best fit then tighten screws to hold in place.

D. Repeat for remaining front mud flap.

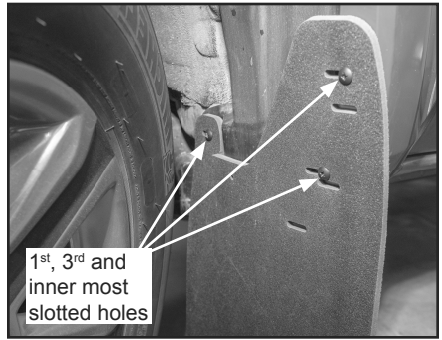

### 3: INSTALLING MUD FLAPS TO REAR

**NOTE:** Rear mud flap installation uses 4 mounting holes per mud flap, see PARTS DIAGRAM (page 2) for locations.

A. Use 10 mm socket or Phillips screwdriver to remove lower factory screws indicated in adjacent image.

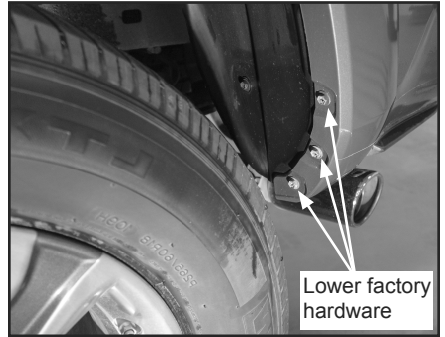

B. Install mud flaps with (3) #14 x 1-1/4" Phillips head hex screws through 2<sup>nd</sup>, 4<sup>th</sup> and 5<sup>th</sup> slotted holes into newly free holes in wheel well. Leave screws loose for now.

C. Level mud flap while adjusting placement to obtain best fit then tighten screws to hold in place.

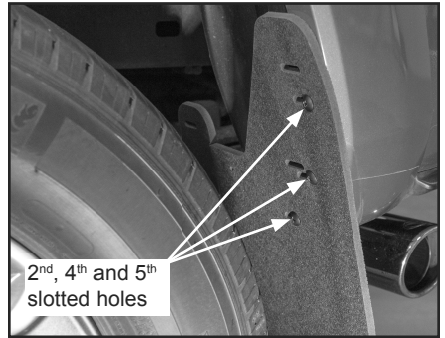

D. Verify mud flap is level then install #10 x 1-1/4" self-drilling hex screw with washer at pinhole guide. Secure with nylon hex nut.

E. Repeat for remaining rear mud flap.

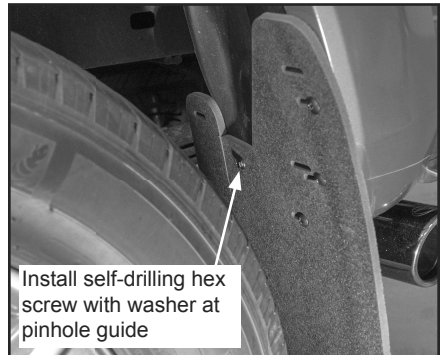

# SAFETY AND MAINTENANCE

The operator can perform most of inspection and maintenance. It may be necessary to review the installation instructions.

- Periodically check all screws, washers and nuts, retighten if needed.
- If mud flap has been damaged, replace with new one.

**NOTE:** Inspection and/or maintenance should be performed anytime a malfunction is observed or suspected. If you need assistance inspecting and/or servicing your mud flaps, call customer service at 888-568-3709. Always use original equipment replacement parts for your mud flaps.



# MANUFACTURER'S LIMITED WARRANTY

Agri-Cover, Inc. extends the following (1) year Limited Warranty for the ROCKSTAR™ Splash Guard Mud Flaps:

Agri-Cover, Inc. warrants a period of one (1) year from the date of manufacture that its ROCKSTAR™ Splash Guard Mud Flaps are free from defects in workmanship, under normal use for the truck model it was intended for. This Limited Warranty does not cover any damage due to accident, abuse, misuse, alteration, neglect, improper installation, or ordinary wear and tear.

Agri-Cover, Inc.'s sole obligation under this Limited Warranty is limited to the repair or replacement at its option, of defective parts only. No labor or service allowance is given or implied. IN NO EVENT SHALL AGRI-COVER, INC. BE LIABLE FOR INCIDENTAL, CONSEQUENTIAL, OR SPECIAL DAMAGES. AGRI-COVER, INC. EXPRESSLY DISCLAIMS ANY AND ALL IMPLIED WARRANTIES OF MERCHANTABILITY, AND THERE ARE NO WARRANTIES WHICH EXTEND BEYOND THE LIMITED WARRANTY DESCRIPTION CONTAINED HEREIN.

For warranty, have serial number ready and fill out the warranty claim form at [agricover.com/warrantyclaim](http://agricover.com/warrantyclaim) or call Customer Service Department at 888-568-3709 to determine if only a replacement part is needed or if the mud flaps needs to be returned for inspection and repair. Goods to be returned must have a pre-authorized RA # (Return Authorization Number) - obtained by calling the number above. Mark the number on the package and ship it freight prepaid to address below. Agri-Cover, Inc. will pay freight to return goods to sender.

This Limited Warranty gives you specific legal rights and you may have other rights, which vary, from state to state.

For replacement parts shop at [rockstarmudflaps.com](http://rockstarmudflaps.com) or call Customer Service at 888-568-3709.



Agri-Cover, Inc.  
Customer Service Dept  
3000 Hwy 281 SE  
Jamestown, ND 58401  
Phone: 888-568-3709

**Hours: 8:00 am - 5:00 pm CST Monday through Friday, except Holidays**