

Console Arm Rest/Phone Holder

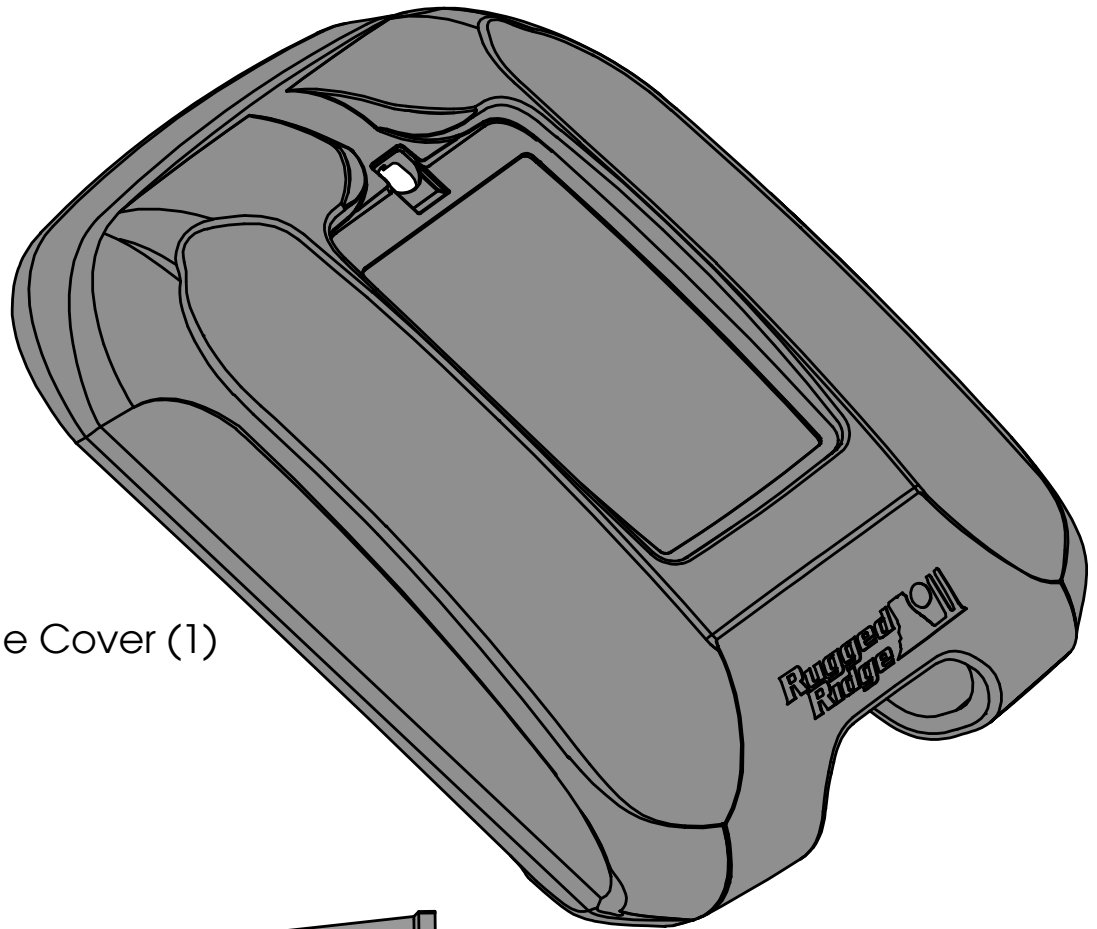

Console Cover (1)



Cable Retention Strip (2)

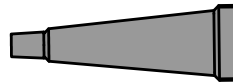

Adhesive Promoter (1)

OMIX-ADA® TECHNICAL SUPPORT

PHONE: M-F 8am - 5pm EST 1-800-449-6649 | **EMAIL:** techsupport@omix-ada.com

FOR WARRANTY INFORMATION VISIT: www.Omix-Ada.com

Console Arm Rest/Phone Holder

1. Position phone charger cable in retention slot on underside of Console Cover. Feed two to three inches of phone charger cable through charger access port.

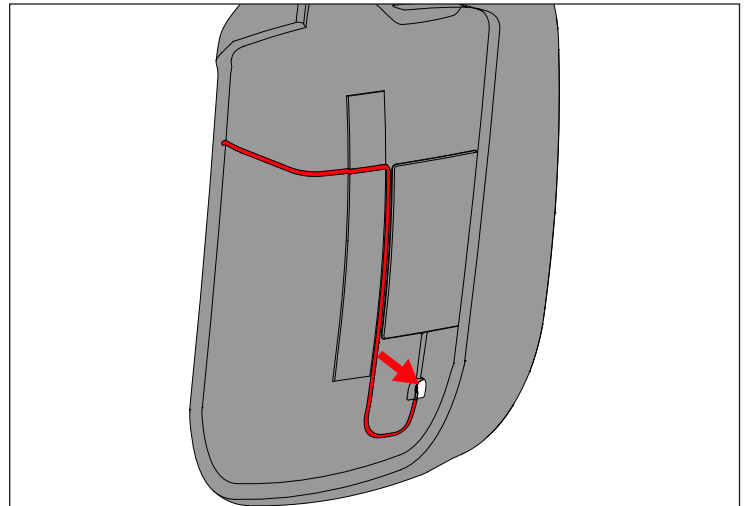

2. Using Isopropyl alcohol, clean shown area on Console Cover. Apply Adhesive Promoter to mounting surface and let dry for 5 minutes.

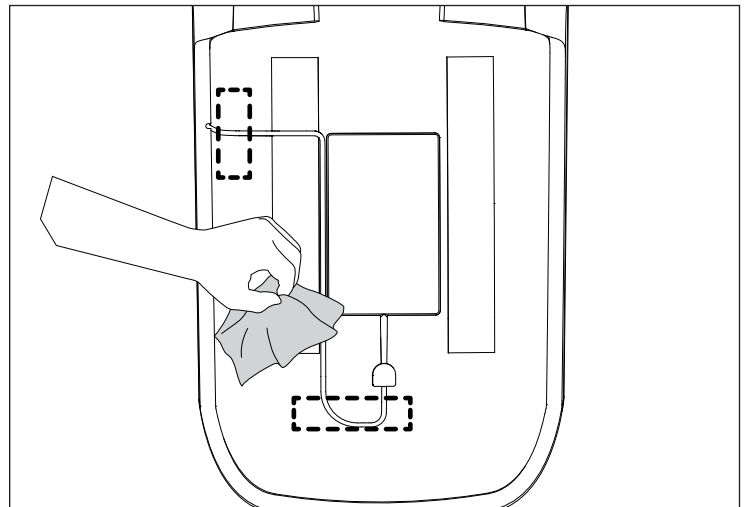

3. Remove tape liner from Cable Retention Strips. Install Cable Retention Strips to secure cable into position. Maintain pressure for 30 seconds. Full adhesion occurs within 24 hours of application.

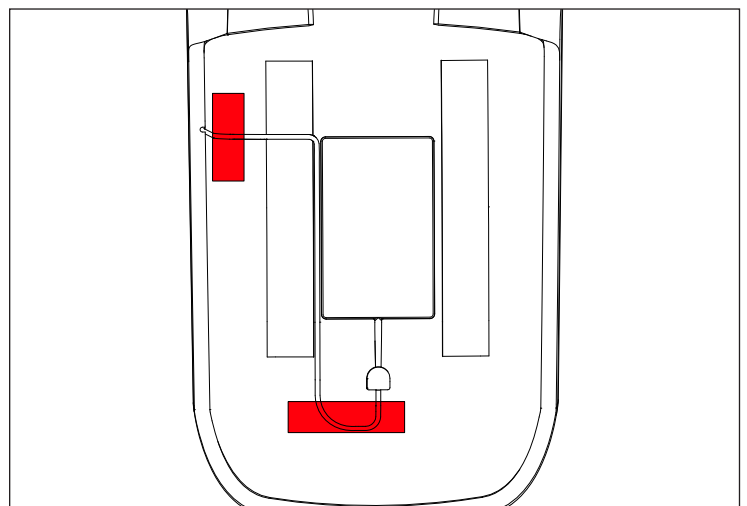

Console Arm Rest/Phone Holder

4. Using Isopropyl alcohol, clean OE Center Console. Apply Adhesive Promoter to mounting surface and let dry for 5 minutes.

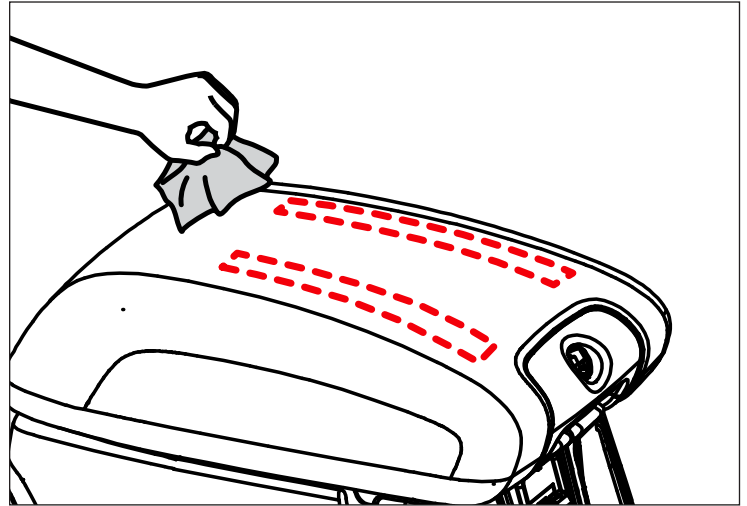

5. Remove tape liner from Console Cover.

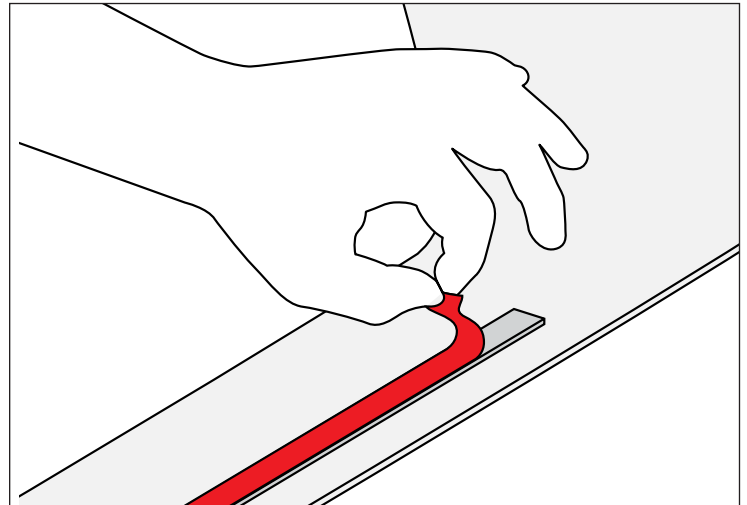

3. Install Console Cover and maintain pressure for 30 seconds. Full adhesion occurs within 24 hours of application. Feed extra phone charger cable through port in OE Center Console.

