

Raptor

Series



Your satisfaction is important to us, please let us help!

If you have any questions or concerns during the installation, our support representatives are available to assist you.

Please call: 1-877-769-3765 or Live Chat at www.raptorseries.com

If you have damaged or missing parts please contact the company you purchased the product from and notify them of the issue right away.



CAUTION: Do not install damaged parts!!!

Raptor

Series

Easy Return / Easy Exchange

Want to return an item or exchange? Not satisfied with purchase?

No problem. We strongly believe in service after the sale and we stand behind our products and our service to you, our valued customer. There is no problem we can't solve for you!

Items that have been installed and/or damaged after receipt, are no longer in new and ready-to-sell condition and cannot be refunded, replaced or exchanged unless it has a manufacturer defect or was damaged in shipping. In addition, we cannot accept return on items that are not in the original packaging. Items returned in poor condition or having parts missing will not be credited.

Please note: Your request for return or replacement must be initiated within 30 days of delivery of your merchandise.

Did your order arrive damaged?

Please do not install damaged products. Contact the company you purchased your product from as soon as possible and notify them of the damages. They will make arrangements with you to assist with the problem.

Did you order the wrong part or receive the wrong item?

Don't worry. From time to time human error can result in problems with ordering or shipping. Contact the company you purchased your product from as soon as you notice the error. Every company has their own policy on returning parts that have been ordered incorrectly or shipped incorrectly.

In the event that you need to ship your part back to return/exchange, please ship to the warehouse below:

**CYC Returns Warehouse
2415 Cathy Lane
Jasper, IN 47546**

The logo for the Raptor Series, featuring the word "Raptor" in a large, green, stylized script font, with the word "Series" in a smaller, grey, sans-serif font directly below it. The background of the logo is a faint, light green silhouette of a raptor in flight.

Raptor Series Warranty

LIMITED TEN (10) YEAR WARRANTY

For Powder Coated Steel Products

CYC Engineering, Inc. guarantees the original purchaser of our products a limited ten (10) year warranty from the date of original purchase against manufacturer defects in materials, workmanship and finish under normal use. The step pads are covered under warranty for 1 year. This warranty does not include damage resulting from road hazards such as gravel or other debris, product misuse, improper installation, impairments from accidents, product modifications, product neglect or scratches during the life of the product. This limited ten year warranty applies only to new products and is limited to the repair or replacement of company's products. Warranty does not include costs of removal, installation, labor, inconvenience or consequential damages. Original purchaser must return defective merchandise along with the purchase receipt, to the original place of purchase.

LIMITED LIFETIME WARRANTY

For Stainless Steel Products

CYC Engineering, Inc. guarantees the original purchaser of our products a limited lifetime warranty from the date of original purchase against manufacturer defects in materials, workmanship and finish under normal use. The step pads are covered under warranty for 1 year. This warranty does not include damage resulting from road hazards such as gravel or other debris, product misuse, improper installation, impairments from accidents, product modifications, product neglect or scratches during the life of the product. This limited lifetime warranty applies only to new products and is limited to the repair or replacement of company's products. Warranty does not include costs of removal, installation, labor, inconvenience or consequential damages. Original purchaser must return defective merchandise along with the purchase receipt, to the original place of purchase.

2003-0355, 2003-0355BT

5" OVAL RUNNING BOARD



Components:

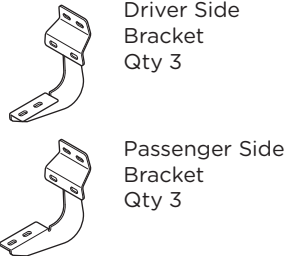

Driver Side Bracket Qty 3

Passenger Side Bracket Qty 3

Hardware:

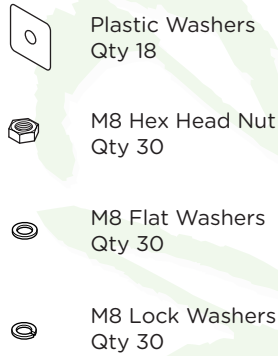

Plastic Washers Qty 18

M8 Hex Head Nut Qty 30

M8 Flat Washers Qty 30

M8 Lock Washers Qty 30

Tools Required:

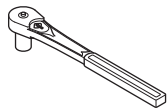

RATCHET

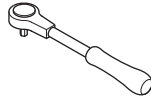

TORQUE WRENCH



13MM SOCKET

Torque Specifications:

For Rocker Panel Mount Installations
M8 through M12 bolts and nuts are set to 15-20 ft lbs.

Note: When installing the brackets and boards, all hardware must be left loose until all the items are attached.

1. Remove all contents from the package and check running boards for any damage. Also, verify that all components and hardware listed above are included before you begin installation.

Begin on driver side of vehicle.

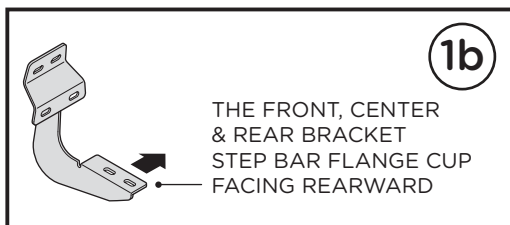
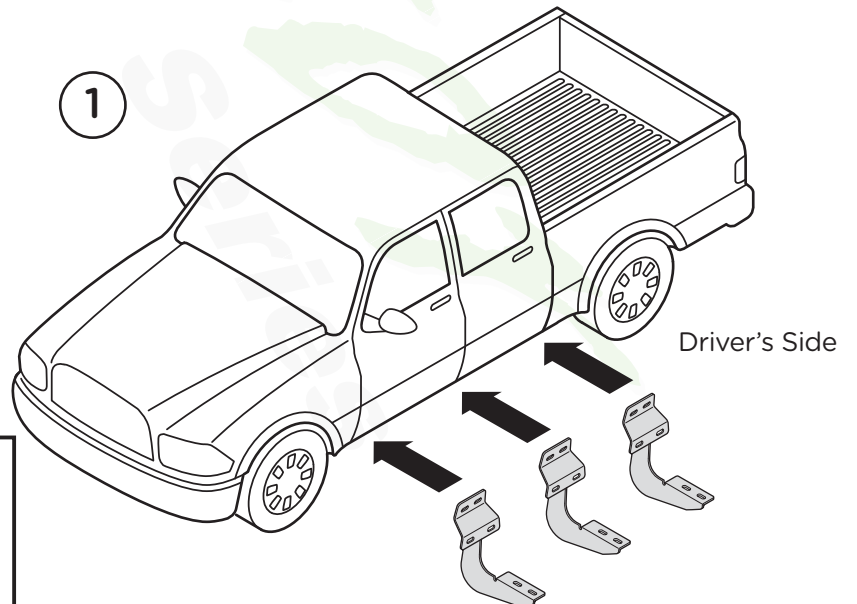

3

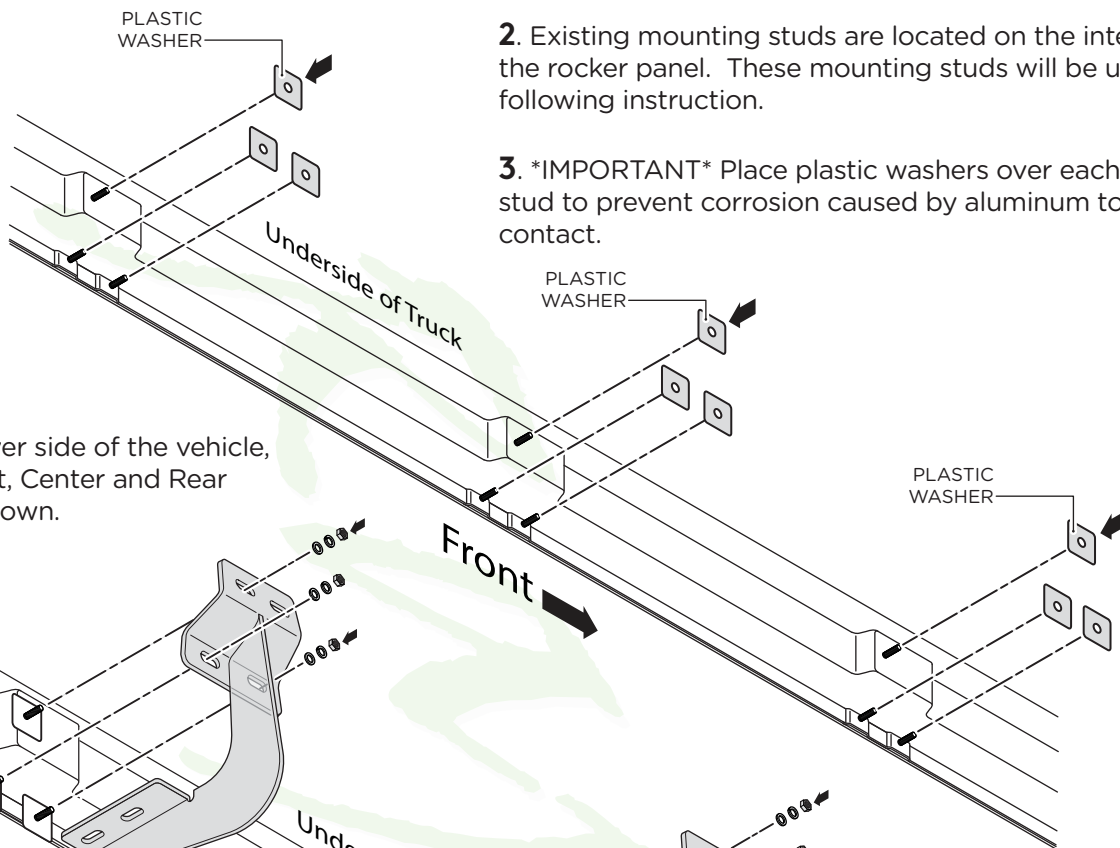

2. Existing mounting studs are located on the interior wall of the rocker panel. These mounting studs will be used for the following instruction.

3. ***IMPORTANT*** Place plastic washers over each mounting stud to prevent corrosion caused by aluminum to steel contact.

4. On the driver side of the vehicle, align the Front, Center and Rear brackets as shown.

5

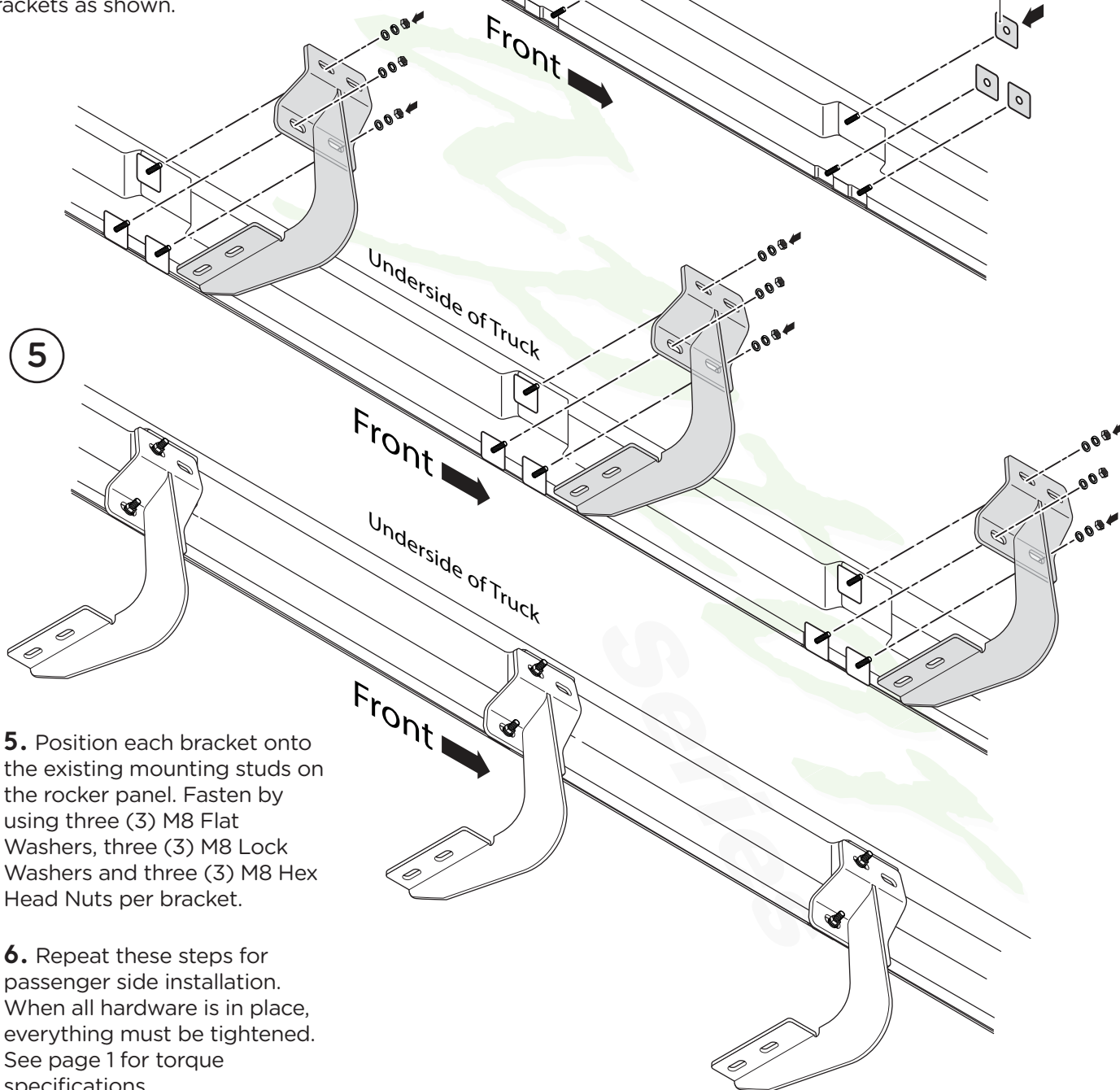

5. Position each bracket onto the existing mounting studs on the rocker panel. Fasten by using three (3) M8 Flat Washers, three (3) M8 Lock Washers and three (3) M8 Hex Head Nuts per bracket.

6. Repeat these steps for passenger side installation. When all hardware is in place, everything must be tightened. See page 1 for torque specifications.

5" OVAL RUNNING BOARD

Raptor
Series

1. Place Running Board on brackets. Each running board is marked Driver and Passenger.

2. Slide M8 threaded studs in track system on the bottom of the Running Board to line up to mounting holes in each bracket.

3. Fasten Running Board on each bracket by using two (2) M8 Flat Washers, two (2) M8 Lock Washers and two (2) M8 Hex Head Nuts per bracket.

When all hardware is in place, everything must be tightened. Tighten until the split lock washer is flat between the M8 Flat Washer and M8 Hex Head Nut.

Repeat these steps for driver side installation.

