

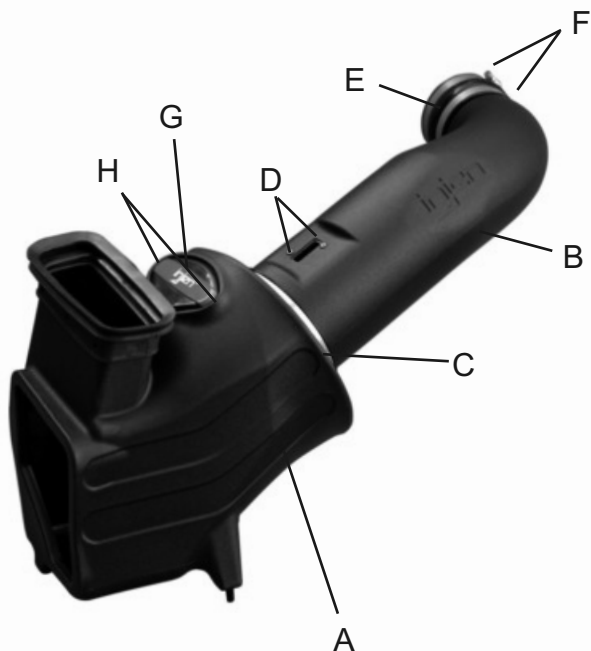

Vehicle Application:
 Make: **GMC/Chevrolet**
 Model: Sierra 2500/3500
 Silverado 2500/3500
 Year: **2017-18**
 Engine: **6.6L V8 Turbo Diesel L5P**



Item	QTY.	P/N	Discription
A	1	#15147	Airbox
B	1	#15148	Intake tube
C	1	#1113BB	Dry filter (Blue Media) ^{EVO7007}
D	2	#6047	M4 Button Head Screws
E	1	#3168	4.00" Step Hose
F	2	#4006	#64 Clamps
G	1	#15139	Small window
H	2	#6109	Lock clips

TOOLS REQUIRED
 10mm Ratchet & Socket
 8mm nut driver
 Allen key
 Phillips Screwdriver
 2.5mm Allen
 13mm socket and ratchet

WARNING: FAILURE TO FOLLOW INSTALLATION INSTRUCTIONS AND NOT USING THE PROVIDED HARDWARE MAY DAMAGE THE INTAKE SYSTEM, ENGINE AND COMPONENTS!!!
***Do not attempt to install the intake system while the engine is hot.**
 Severe burn could result from touching hot engine components!

Report any defective or missing parts to the authorized Injen dealer you purchased this product from. Before installing any parts of this system, please read the instructions thoroughly. If you have any questions regarding installation, please contact your Injen Technology dealer. Installation DOES require some mechanical skills. A qualified mechanic is always recommended.

A Limited Lifetime Warranty to the original purchaser against defects in material and workmanship on all Injen intake systems excluding the filter element. Any and all warranty coverage is limited to the repair or replacement of the defective part only, at Injen Technology's discretion. The warranty does not cover incidental or consequential damages, nor does it cover the cost of installation or removal of the defective part or its replacement. Proof of purchase is required.

Instruction Manual P/N:EVO7007

Injen intake systems are street legal in most states unless the state is adopting to California Emissions standards. States that have adopted California emission standards include: Arizona, California, Connecticut, District of Columbia, Maine, Maryland, Massachusetts, New Jersey, New Mexico, New York, Oregon, Pennsylvania, Rhode Island, Vermont, and Washington. These states will require an California Air Resource Board Executive Order Number (CARB E.O.) for the legal use of an Injen intake system in your vehicle for use on public roads or highways. These vehicle will be considered "Legal in California only for racing vehicles competition use only, which may never be used upon a public street or highway. **Please keep your factory air box assembly for any future use.**

NOTE: Verify your filter before any cleaning maintenance!

Blue media filter: Dry Air Filter, no oil required.

(SuperNano Web Dry filters require no oil, these can be cleaned using a vacuum or light compressed air. Please do not clean using water or injen restore kit.)

Red media filter: Factory Oiled Air Filter.

(Oiled cotton gauze filters require oil, please use injen restore kit. This filter can use water or cleaning solution for maintenance.)

Please visit injen.com for filter cleaning instructions.



NOTE: DISCONNECT BATTERY BEFORE INSTALLATION!!!

Instruction Manual P/N:EVO7007



1. Stock intake system shown.

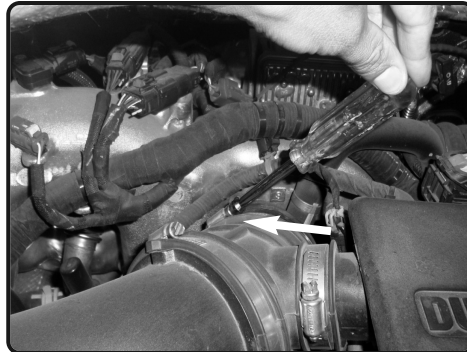

2. Loosen the clamp on turbo suing 8mm nut driver.



7. Disconnect the MAF sensor harness. Pull line away from the air box.

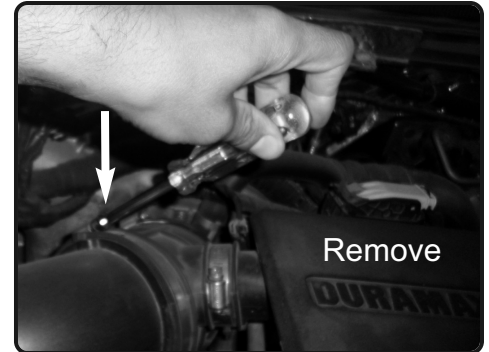

3. Loosen clamp on intake tube. Loosen the nut holding in the Duramax resonator box and remove. Lift up and remove the OEM air box out of vehicle.



4. With pliers, loosen and carefully pull back push clips and remove the OEM rubber hood seal. Save clips and seal for later install



5. OEM rubber hood seal will install to the new injen air box.



6. Place the seal on top and line up holes.



7. With original push clips, install and secure the front.



8. Install and secure the back side.

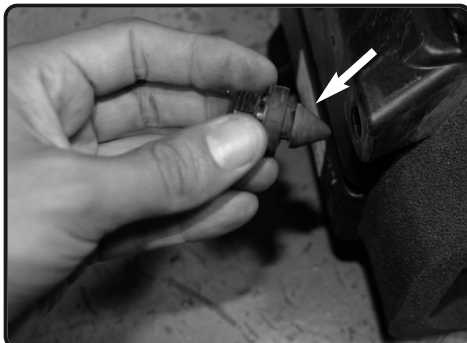

9. Remove the grommet lock spacer from the factory air box.



10. Now install the grommet lock spacer into the new injen air box and secure.



11. Insert twist lock filter to the air box



12. Once seated, rotate in either direction 1/4 turn till filter locks and is secured.



13. Install the injen airbox into the vehicle and position to the OEM air box location and secure.

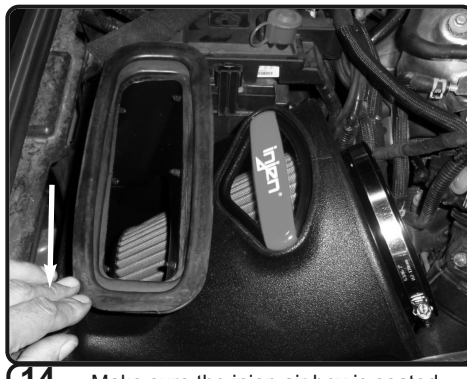

14. Make sure the injen air box is seated and secured properly into the OEM bracket. Make sure grommet from step 9 is locked in and seated in bracket.

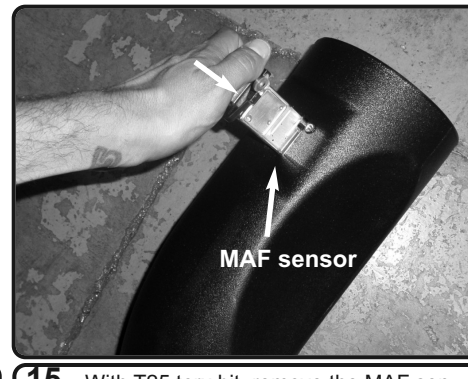

15. With T25 torx bit, remove the MAF sensor from the factory intake tube and install into new injen intake tube and secure using provided M4 screws.



16. Install the provided 4" hump hose with clamps. Install the intake tube. *(coolant line is optional to run on top or below intake tube)* Position intake tube.



16. Adjust the tubr for correct fit. Make sure the tube is bottom-out on filter. this will allow for the Rubber hood seal to seat properly. Secure and tighten using 8mm nut driver.



18. Secure and tighten the clamps on turbo using 8mm nut driver.

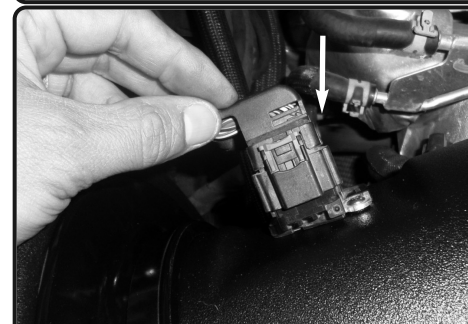

19. Re-connect the MAF sensor harness.



Congratulations! You have just completed the installation of this intake system. Periodically, check the alignment of the intake, normal wear and tear can cause nuts and bolts to come loose. **Note: Check clearance and adjust if needed! Failure to check the alignment and adjust the intake can cause damage that will void the warranty. Injen Technology is not responsible for any damages caused by/from improper installation.**

Test Drive:

1. With the transmission in neutral or park and the parking brake engaged, start the engine. Listen for air leaks or odd noises. If air leaks are detected, secure hoses and connections. For any odd noises, inspect entire system for cause and adjust intake as needed. The Injen intake will function identically to the factory system but will be louder and more powerful.
2. Perform a road test. Listen for odd noises or rattles and fix as necessary.
3. If there are no issues, continue to enjoy your added performance from the Injen performance Intake kit.
4. Injen Technology recommends you periodically check clearance and adjust if needed! Failure to check the alignment and adjust the intake can cause damage that will void the warranty. Injen Technology is not responsible for any damages caused by/from improper installation.

1. Upon completion of the installation, reconnect the negative battery terminal before you start the engine.
2. Align the entire intake system for the best possible fit. Once the intake has been properly fitted continue to tighten all nuts, bolts and clamps.
3. Periodically, recheck the alignment of the intake system and make sure there is proper clearance around and along the length of the intake. Failure to follow proper maintenance procedures may cause damage to the intake and will void the warranty.
4. Start the engine and listen carefully for any odd noises, rattles and/or air leaks prior to taking it for a test drive. If any problems arise go back and check the vacuum lines, hoses and clamps that maybe causing leaks or rattles and correct the problem.
5. Check the filter for excessive dirt build up. Clean or replace the filter with an original Injen filter (can be bought on-line at "injenon-line.com"). Congratulations! You have just completed the installation of the best intake system sold on the market. Enjoy the added power and performance of your new intake system.