

Components and Hardware:

1 & 2.



3 & 4.



Components and Hardware:

1. Front Driver Door Guard (Reference Pink Sticker) (1)
2. Front Passenger Door Guard (Reference Blue Sticker) (1)
3. Rear Driver Door Guard (Reference Green Sticker) (1)
4. Rear Passenger Door Guard (Reference Yellow Sticker) (1)

Tools for Installation:

- VDC Approved Cleaner, if possible, Minimum 70% Isopropyl Alcohol
- Disposable Shop Towels (i.e. Scott Towels)
- Blue Painter's Masking Tape
- Scissors
- 12-oz Rubber Mallet
- Plastic Trim Removal Tool

SCAN THE QR CODES FOR THE INSTALLATION VIDEO & INSTALLATION INSTRUCTIONS

INSTALLATION VIDEO



INSTALLATION INSTRUCTIONS



Important Information

WARNINGS

Description	
USING A HAMMER INSTEAD OF THE RECOMMENDED MALLET WILL RESULT IN DAMAGE TO THE DOOR EDGE GUARDS.	
Door Edge Guards are designed to fit your vehicle firmly. Do NOT attempt reinstallation.	

DO NOT install this product if the sealant condition is not appropriate, for more information please contact customer service.

www.huskyliners.com
Phone: 800-344-8759
Email: customerservice@huskyliners.com

The gap requirements only apply to the space the Door Edge Guards will cover



Door Edge Guards

1. Starting with the front driver side door, clean the edges of the door using the recommended Isopropyl Alcohol and a clean disposable shop towel. Rotate the towel after each wipe. Wipe thoroughly until clean.

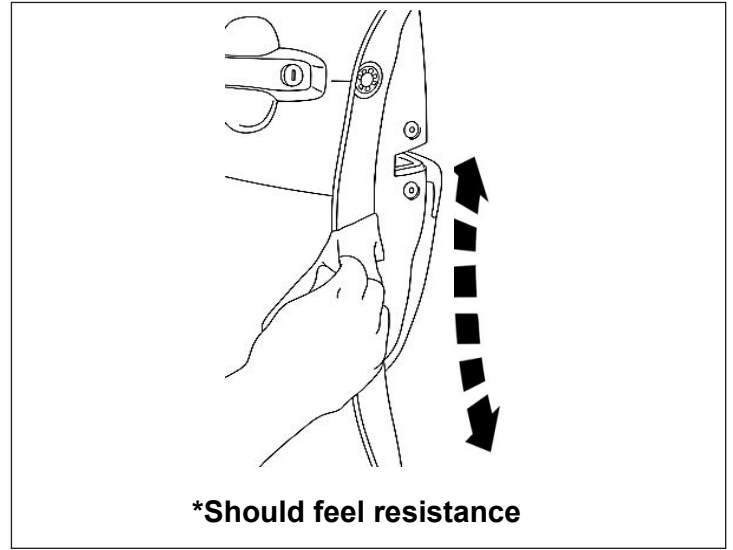

2. Using a dry disposable shop towel, completely dry the edges of the door that was just cleaned. Ensure this area is dry enough to hear the towel squeak across the surface.

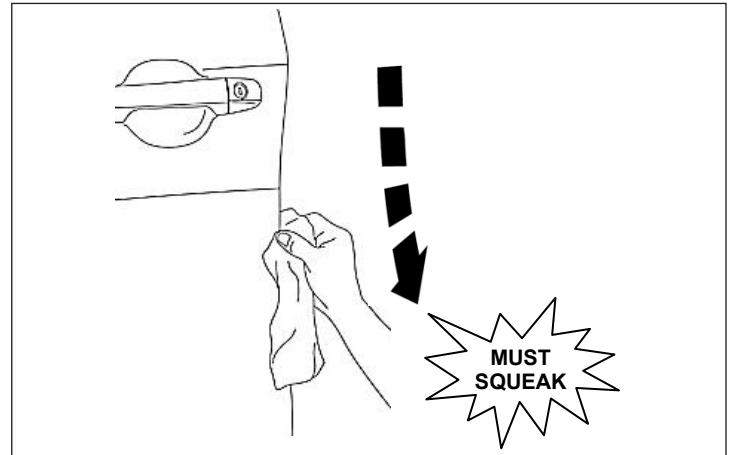

3. Locate the template for the front driver side door on the end pages of the instruction sheet.

Clean the template and the template contact area. Use the same cleaning and drying methods for the contact area as you did for the edge of the door.

Align the template to the edge of the door. Use the recommended masking tape to secure the top and bottom of the template to the vehicle's door.

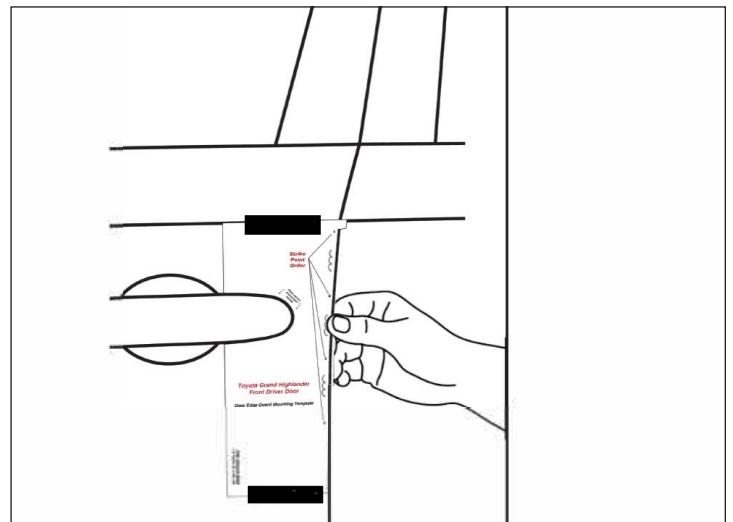

Door Edge Guards

4. Align and place the Door Edge Guard on the edge of the door using the template.

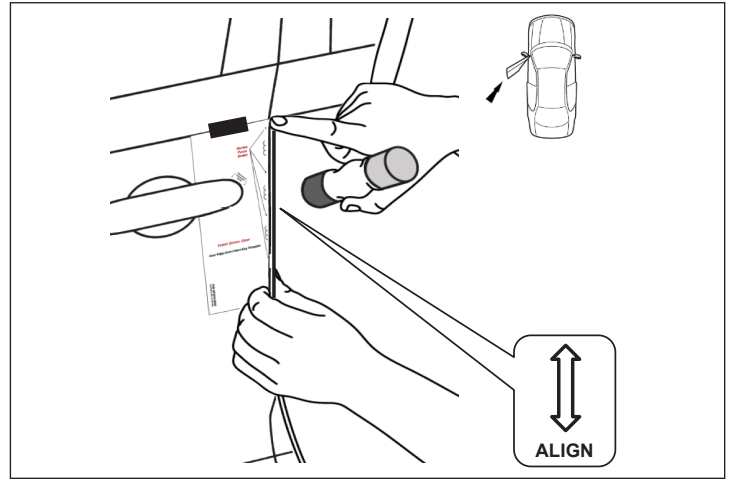

5. Using the recommended rubber mallet, gently strike the top of the Door Edge Guard.

NOTE: Use the darker side of the mallet and ensure the mallet head is perpendicular to the edge of the door.

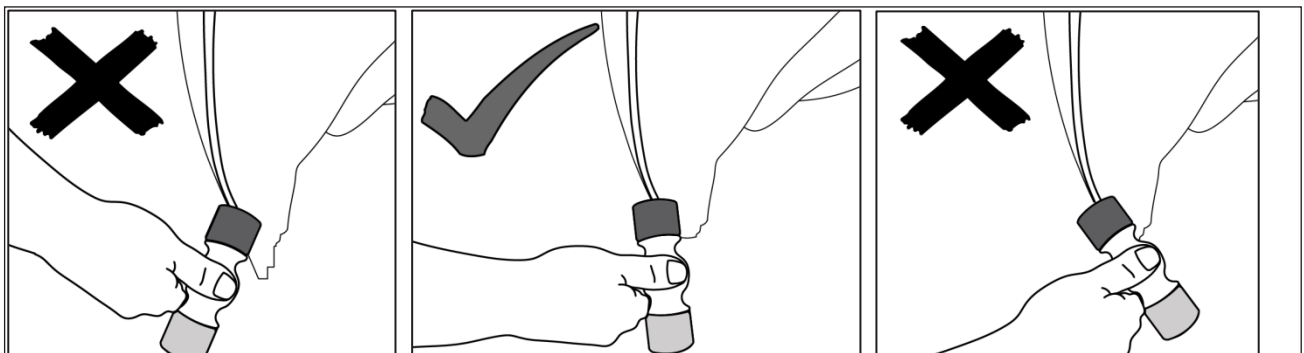
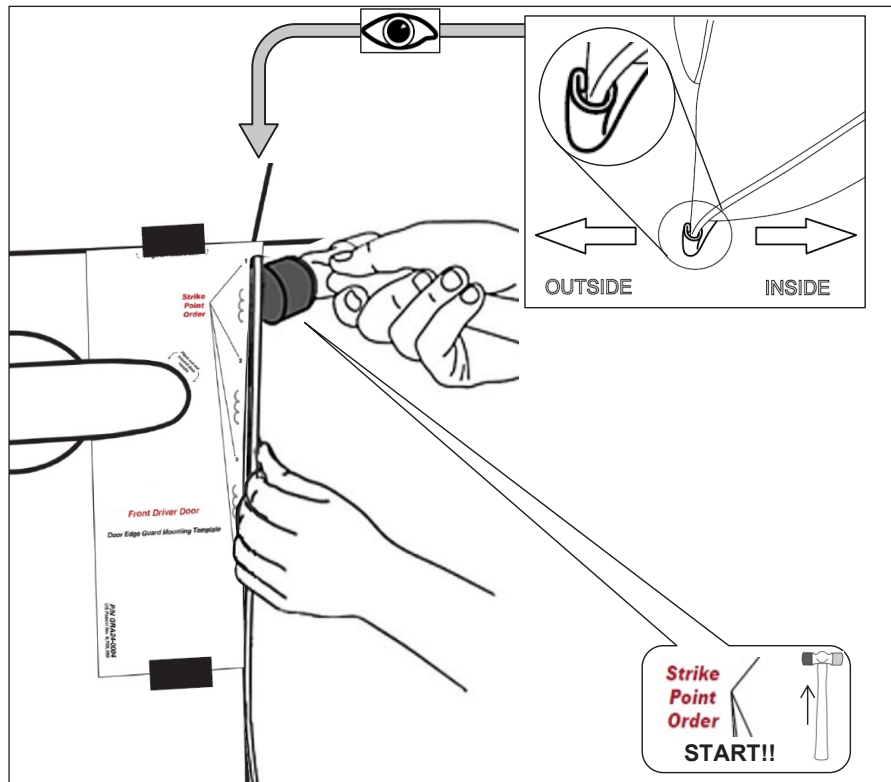

Door Edge Guards

6. Continue gently striking the Door Edge Guard in 1/2" intervals until you reach the bottom.

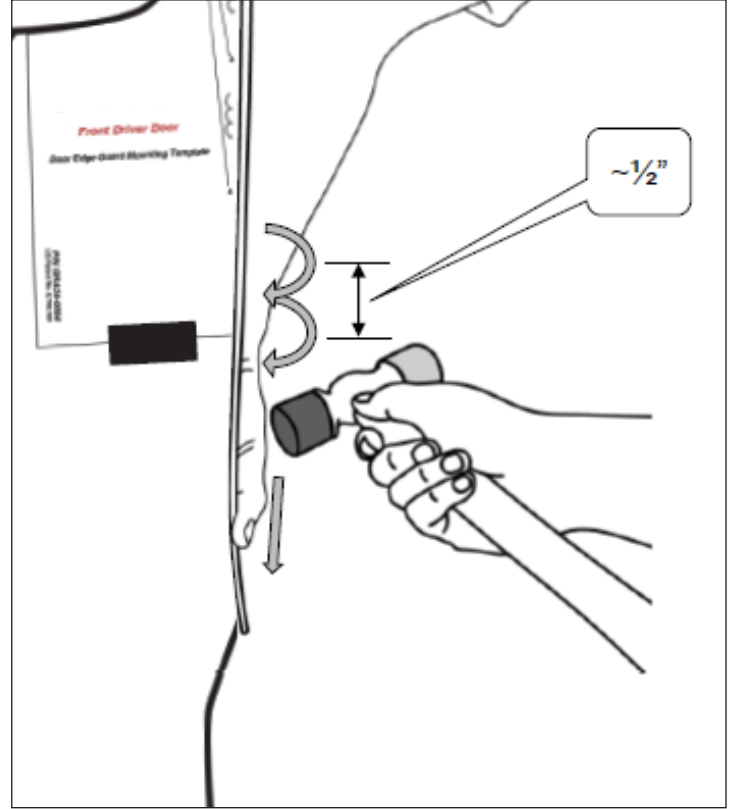
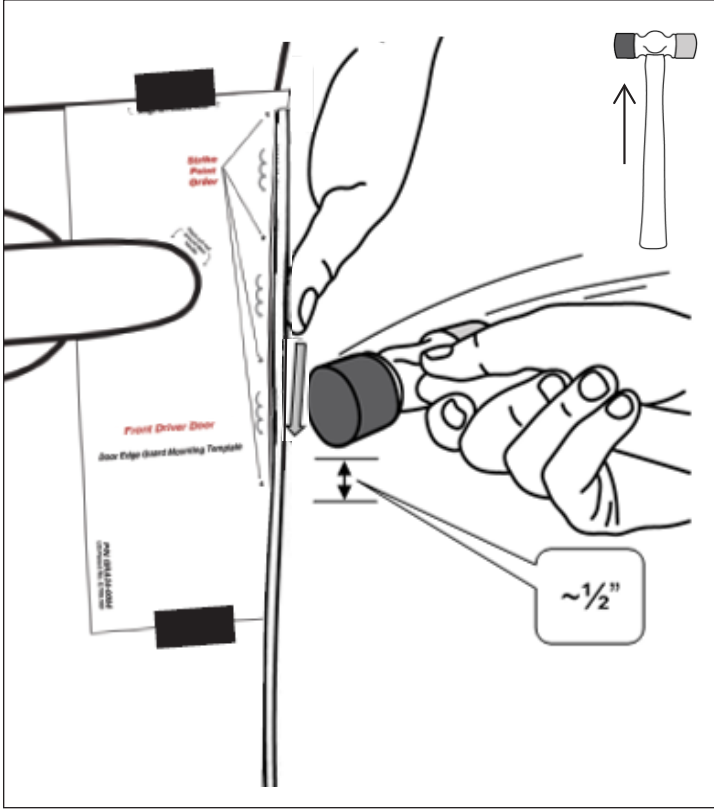

7. Using the yellow side of the rubber mallet, gently strike the Door Edge Guard in 1" intervals.

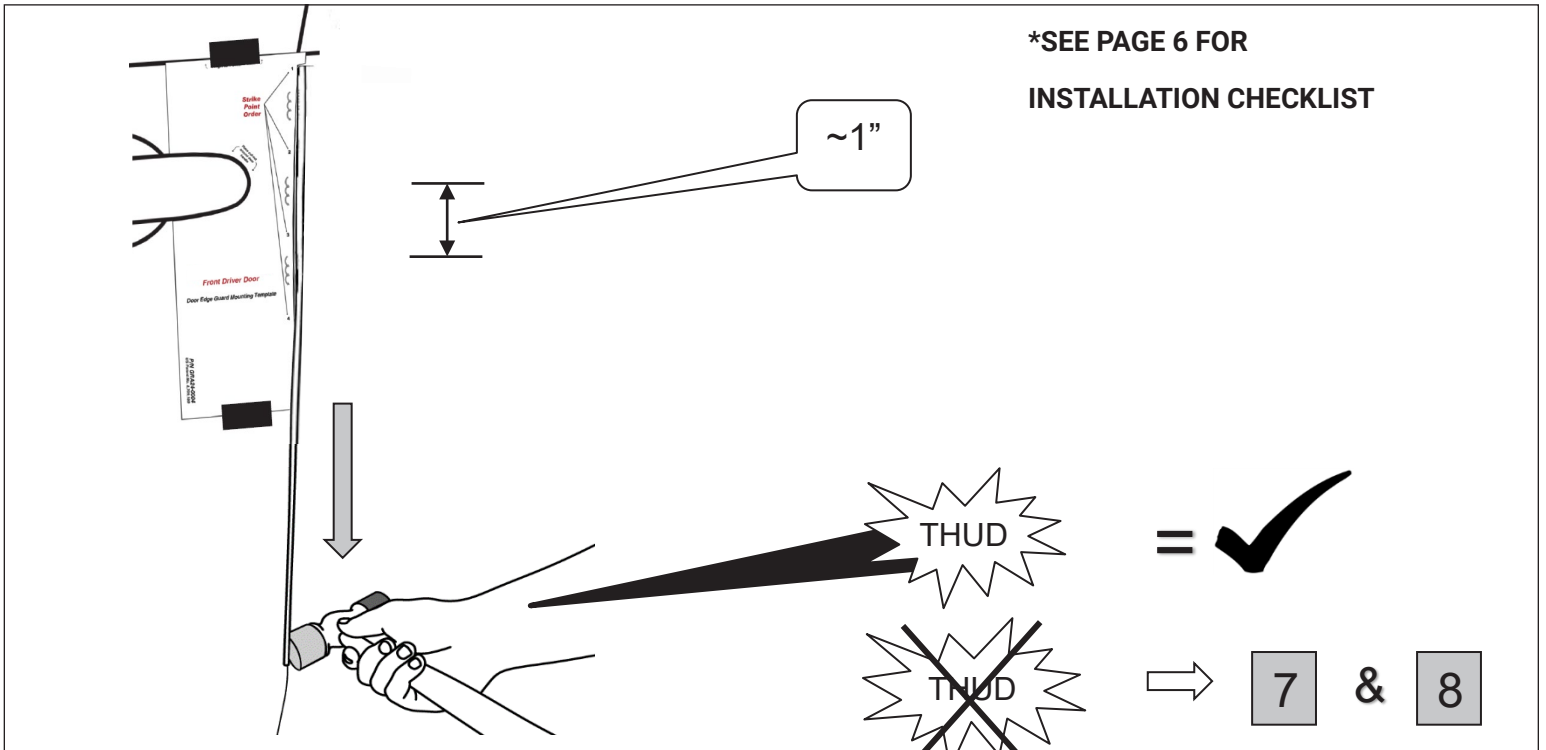

***SEE PAGE 6 FOR
INSTALLATION CHECKLIST**

Door Edge Guards

8. Repeat Steps 1-7 on remaining doors.

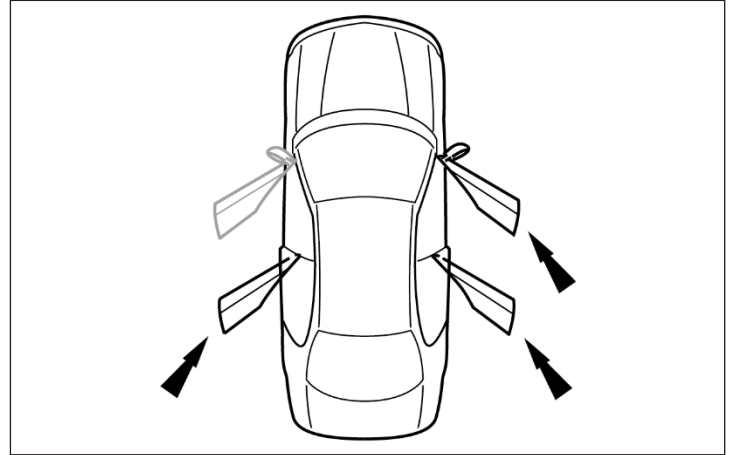

Door Edge Guard Removal - DISCARD AFTER REMOVAL & DO NOT REINSTALL

9. Using the recommended plastic trim removal tool and rubber mallet, gently tap the removal tool into the top of the Door Edge Guard. Work in 1/2" intervals until you reach 4" down the Door Edge Guard.

Start the same process at the bottom, working in 1/2" intervals working up the Door Edge Guard.

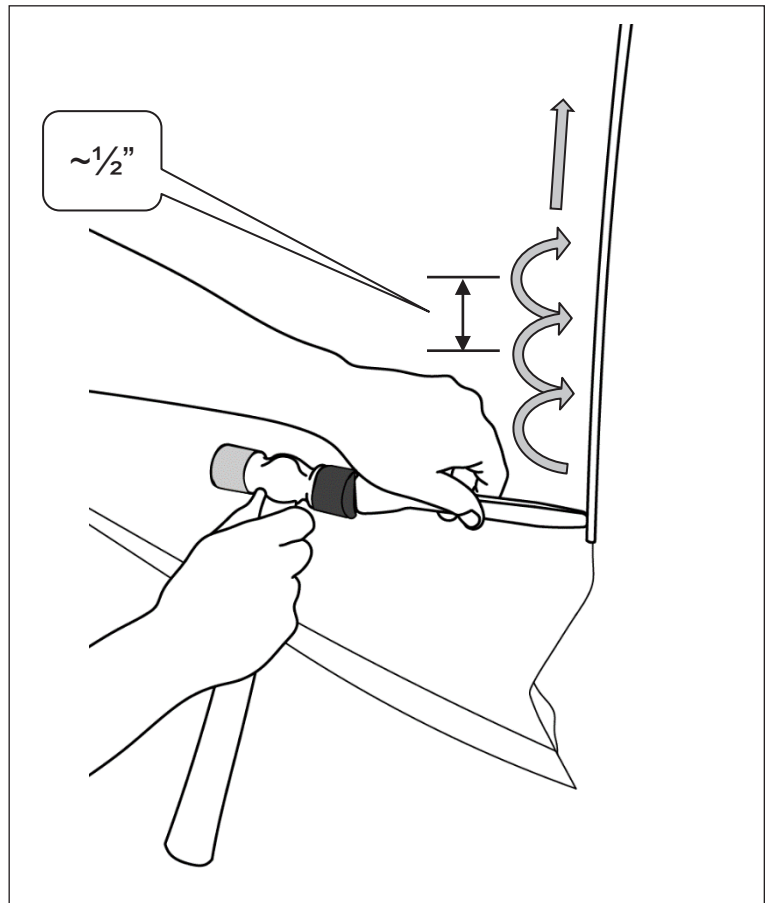
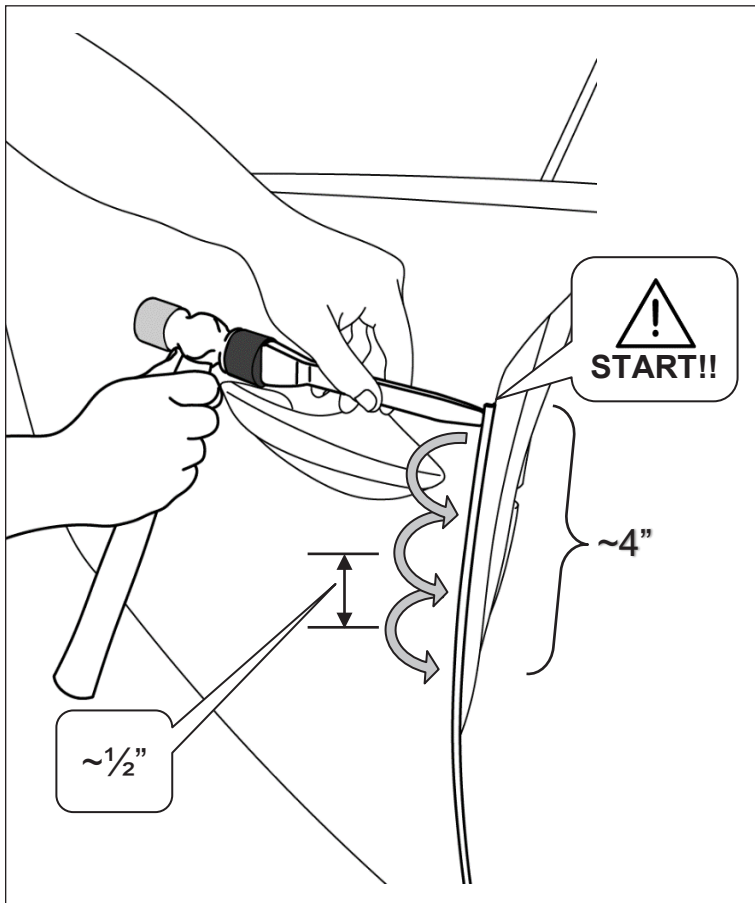

Door Edge Guards

Checklist - These points MUST be checked to ensure a quality installation

<p><u>Check:</u></p> <hr/> <p><u>Accessory Function Checks</u></p> <p><input type="checkbox"/> Confirm all Door Edge Guards are fully seated.</p>	<p><u>Look For:</u></p> <p>Look for a fairly consistent gap between the DEG and adjoining vehicle panels.</p> <p>Gently use forefinger and thumb to pull Door Edge Guard to ensure it is properly seated. Follow the top, middle and bottom sequencing to gently pull the Door Edge Guard. Avoid pulling within 25mm of the very top and bottom of the DEG.</p> <p>NOTE: Normal vehicle manufacturing tolerances may exist that are not a consequence of an improperly seated DEG installation.</p>
<p><u>Vehicle Function Checks</u></p> <p><input type="checkbox"/> Vehicle door operation.</p>	<p>Confirm both doors open and close without interference from DEG or Body Side Molding (if installed).</p>
<p><u>Vehicle Appearance Check</u></p> <p><input type="checkbox"/> After accessory installation and removal of protective cover(s), perform a visual inspection.</p>	<p>Ensure no damage (including scuffs and scratches) was caused during the installation process.</p>

Congratulations!

We take the utmost pride in our products and want you to enjoy years of satisfaction from your investment. We have made every effort to ensure that your product is top quality in terms of fit, durability, finish and ease of installation.

www.huskyliners.com
 Phone: 800-344-8759
 Email: customerservice@huskyliners.com



GUARANTEED...FOR LIFE.

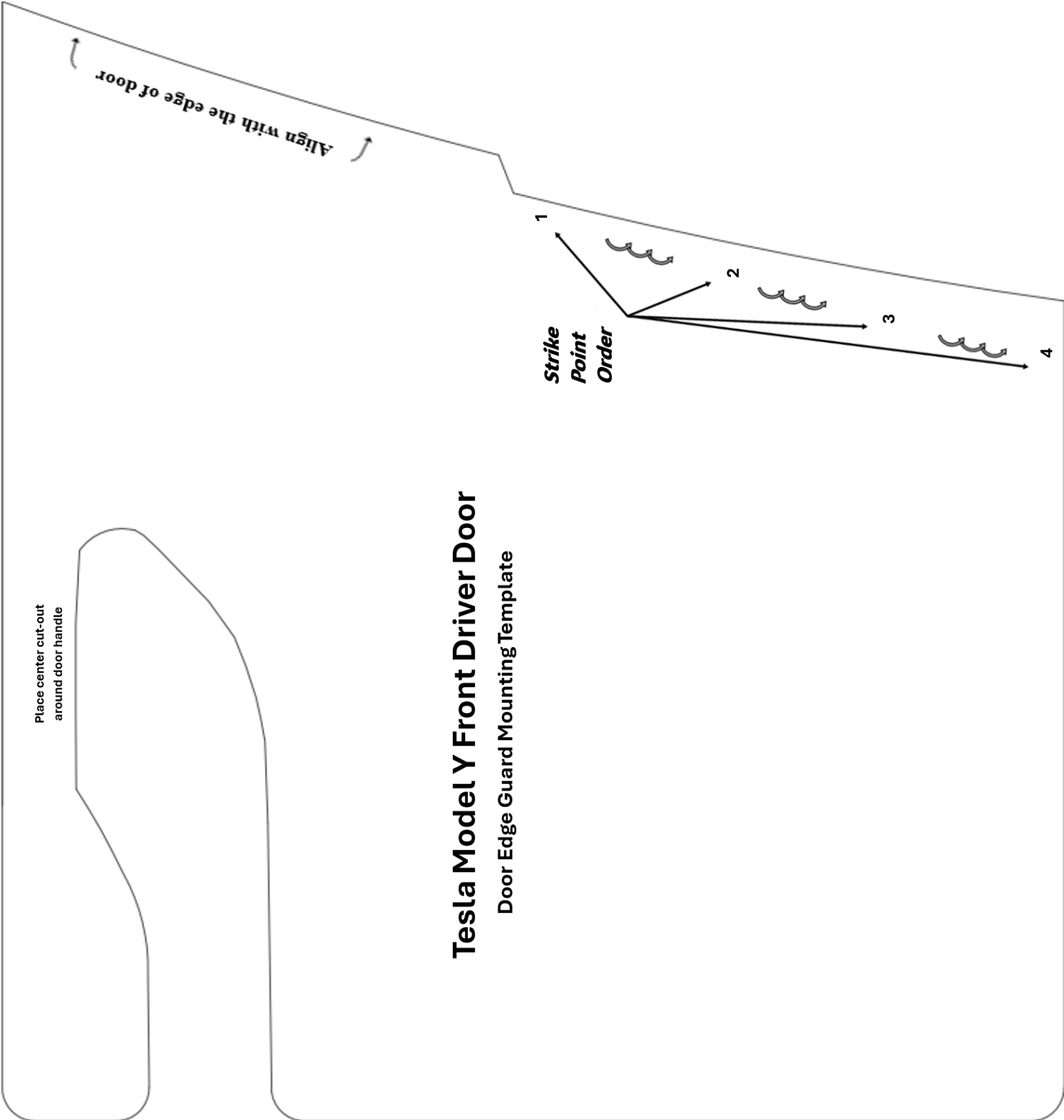

Place center cut-out
around door handle

Tesla Model Y Front Passenger Door

Door Edge Guard Mounting Template

Align with the edge of door

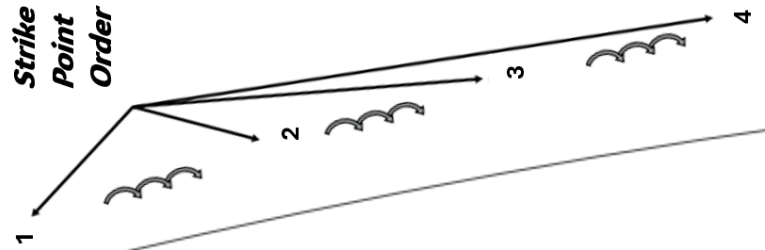

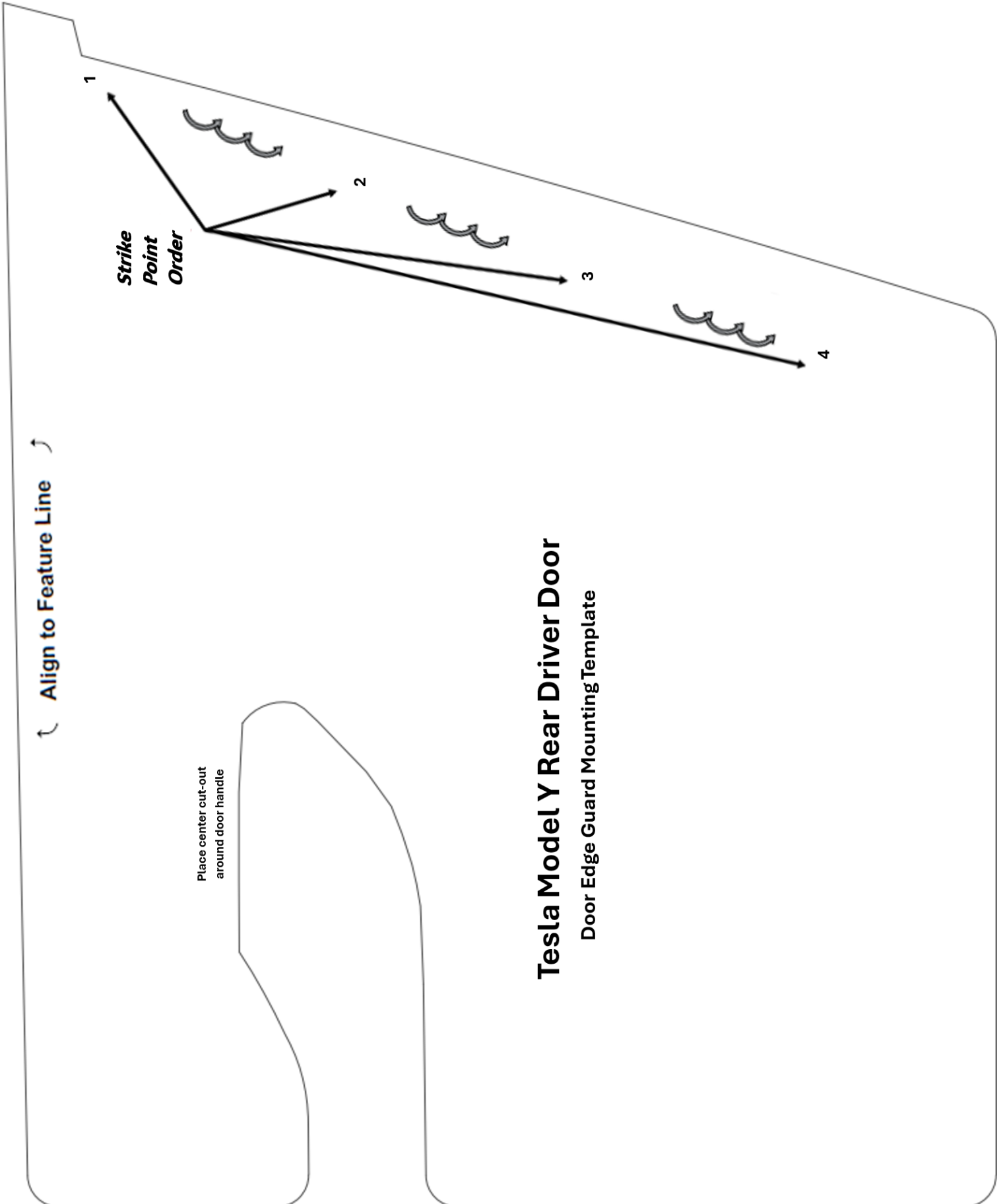

Align to Feature Line ↺ ↻

Place center cut-out
around door handle

**Strike
Point
Order**

1

2

3

4

Tesla Model Y Rear Passenger Door Door Edge Guard Mounting Template

