



**FORD INTERCEPTOR UTILITY SINGLE  
CELL 3 POINT BELT SYSTEM  
INSTALLATION INSTRUCTIONS  
5707313FEM**

**Important Notice: Read all instructions before starting the installation of the seat. Before drilling or installing any screw or fastener into the body of the vehicle it is imperative to ensure the drill bit or fastener will not penetrate any fuel line, fuel tank, brake lines or wires.**



# INSTALLATION INSTRUCTIONS

## PRODUCT SAFETY & LEGAL DISCLAIMER

- Read and understand all safety precautions and instructions before installing this product.
- **Review the product package and contents prior to beginning the installation.** We make every effort to provide a perfect product but we are human and a mistake may happen from time to time. Take care when opening the packaging and removing items. If a return is needed you will want to return the product in its original packaging if possible.
- This product is intended to be installed by a certified technician, therefore a certain level of competence and knowledge are assumed when reading these instructions.
- This instruction guide is provided as a GENERAL installation guide, some vehicles vary dimensionally and may require additional steps.
- **Make certain to completely unpack the contents of the shipping container. Unwrap all parts and inspect parts prior to installing.**
- Test fit the product on the vehicle prior to any third party modifications and or finishing. The manufacturer and distributors will not accept responsibility for third party charges, labor and or third part replacement modifications. Some modifications may void the factory warranty.
- Exercise due-diligence when installing this product. The manufacturer and distributors of this product will not accept any responsibility for vehicle damage or personal injury resulting from the installation of this product. Installation of this product is acceptance of this statement and releases the manufacturer/Distributors of this product from any direct or indirect liabilities.
- Careless installation and operation can result in serious injury or equipment damage.
- Once installation is complete, please return this guide along with other documentation included in this product back to the consumer for future reference. The manufacturer/distributors of this product do not guarantee this particular version will be available at a later date.
- All liability for installation and use rests with the owner/operator.



# INSTALLATION INSTRUCTIONS

## INJURY HAZARD

Please complete a shop and tool inspection prior to beginning the installation.

- Always make sure you have a clean, dry and well-lit work area.
- Always remove jewelry, loose fitting clothing and wear protective gloves and eye protection.
- Always use extreme caution when jacking or raising a vehicle for work. Set the emergency brake and use tire/wheel blocks and jack stands. Refer to the vehicle manufacturer handbook. Utilize the vehicle manufacturers designated lifting points.
- Always use appropriate and adequate care in lifting parts during disassembly and installation. Seek help in lifting heavy or large items into place. Utilize jacks and or lifting devices when available.
- Always ensure products are secure during disassembly and installation.
- Always wear eye protection and take steps to protect any exposed skin during the installations. Drilling, cutting and grinding plastic and metal may create flying particles that can cause injury.
- Always use extreme caution when drilling, cutting and or grinding on a vehicle. Thoroughly inspect the area to be drilled, cut or ground both on the bottom and top of the surface. Ensure no wires, exhaust or any type of liquid lines will or can be damaged while drilling, cutting or grinding. If objects that are not intended to be drilled or cut are in the way of the hole or cut, they will need to be relocated.
- Always assemble and tighten all fasteners per the installation instructions.
- Always route electrical cables carefully. Avoid moving parts, parts that may become hot and rough or sharp edges.
- Always insulate and protect all exposed wiring and electrical connections.

## MAINTENANCE AND CARE

Never use abrasive cleaners or polish compounds. Clean with a gentle soap/disinfectant and water.



**INSTALLATION INSTRUCTIONS  
 FORD INTERCEPTOR SUV  
 SINGLE CELL WITH 3 POINT  
 BELT; 5707313FEM**



**COMPONENT BOX 5UF191A**

ITEM	QTY	DESCRIPTION	ITEM	QTY	DESCRIPTION
A	1	Seat Adapter Bracket (Left Side)	H	1	Seat Belt Bracket (Left Side)
B	1	Seat Adapter Bracket (Right Side)	I	1	Seat Belt Bracket (Right Side)
C	1	Rear Screen Window Assembly	J	1	Center Belt Bracket
D	1	Upper Filler Panel (Left Side)	K	1	Rear Cross Bar
E	1	Upper Filler Panel (Right Side)	L	1	Floor Strut (Left Side)
F	1	Closeout Panel (Left Side)	M	1	Floor Strut (Right Side)
G	1	Closeout Panel (Right Side)	N	1	Center Closeout Panel

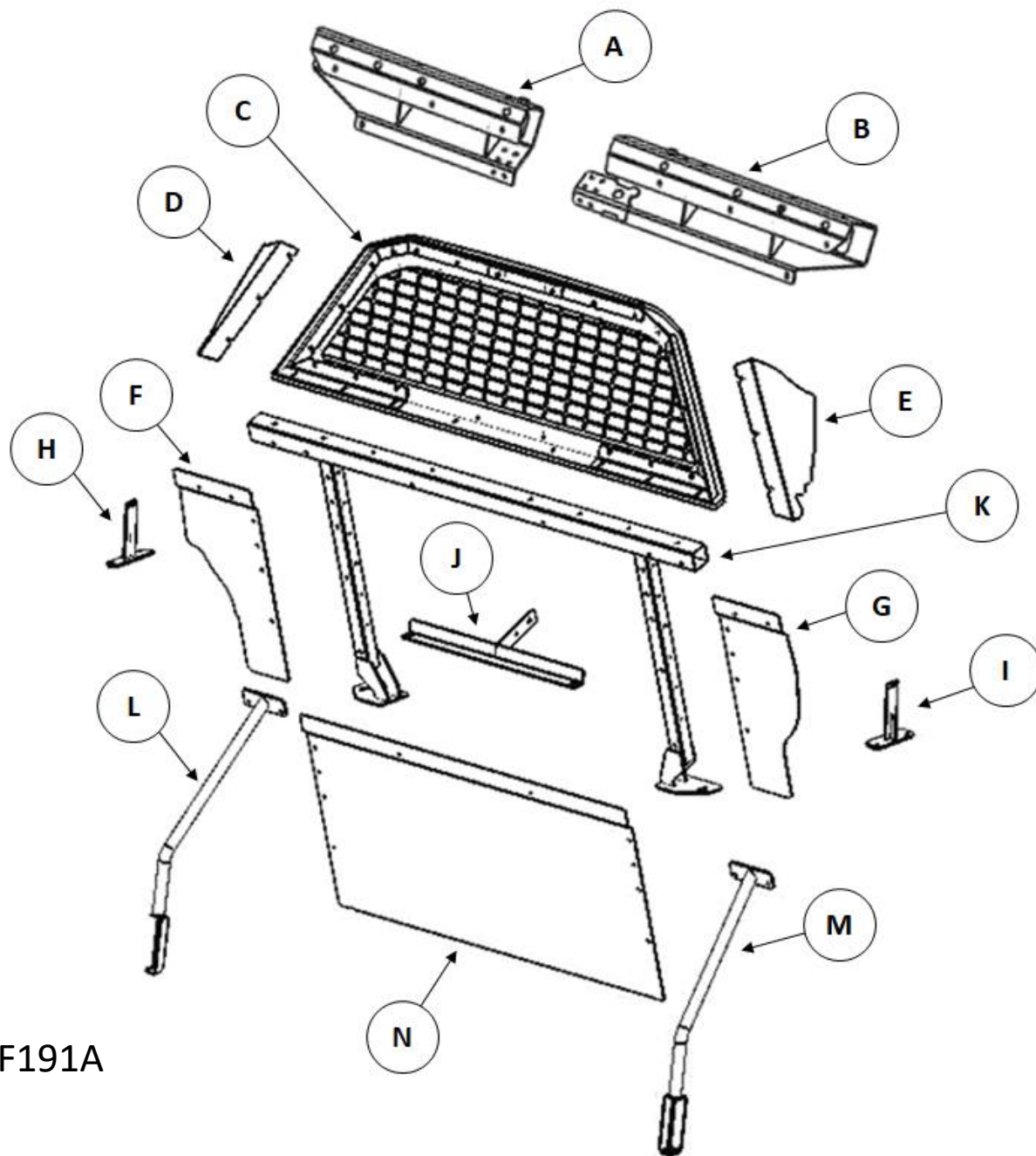

COMPONENT BOX 5UF191A

## PARTS INCLUDED IN THIS LIST:

### COMPONENT BOX 5UF191A

Item	QTY	Description
1	8	Phillips Rounded Head Screw Number 6 X 1/2"
2	4	Countersink Screw Number 8 X 1/2"
3	37	Button Head Hex Drive Screws, 1/4"-20 X 1"
4	33	Split Lock Washer 1/4"
5	37	Flat Washer 1/4"
6	4	Nylon-Insert Locknut, 1/4"-20
7	4	Hex Head Screws 5/16"-18 X 1"
8	4	Flat Washer 5/16"
9	4	Serrated Flange Locknut 5/16"-18
10	1	Hex Head Screw 1/2"-13 X 1-1/2"
11	2	Flat Washer 1/2"
12	1	Nylon-Insert Locknut, 1/2"-13
13	4	Button Head Hex Drive Screw M10 X 1.5mm X 35mm
14	4	Flat Washer M10
15	2	Socket Head Screw M12 X 1.75mm X 45mm
16	2	Split Lock Washer M12
17	2	Flat Washer M12

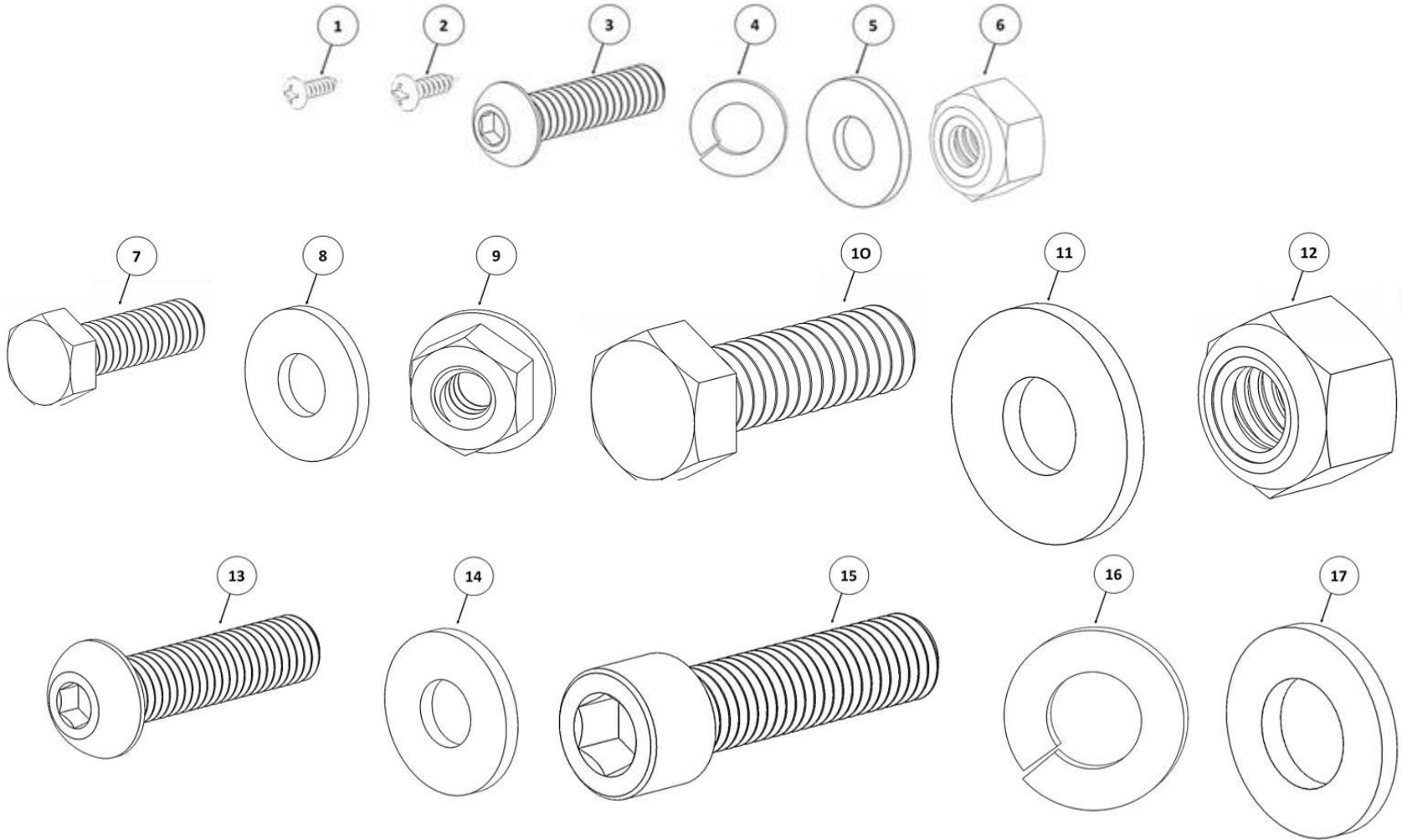

COMPONENT BOX 5UF191A



## PARTS INCLUDED IN THIS LIST:

Item	QTY	Description
18	6	Hex Head Screw 5/16"-18 X 1"
19	6	Lock Washer 5/16"
20	12	Flat Washer 5/16"
21	6	Hex Nut

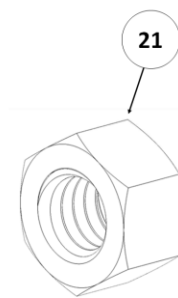
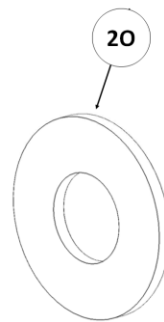
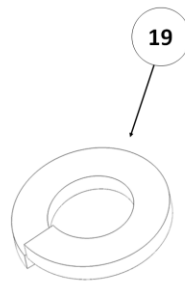
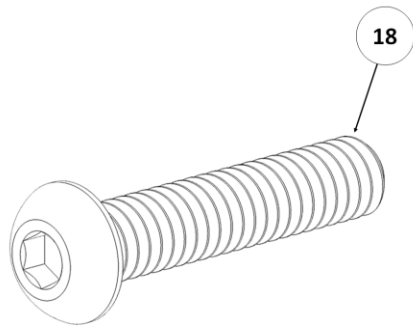





**INSTALLATION INSTRUCTIONS  
 FORD INTERCEPTOR SUV  
 SINGLE CELL WITH 3 POINT  
 BELT; 5707313FEM**



**COMPONENT BOX 570731**

ITEM	QTY	Description	ITEM	QTY	Description
O	1	Single Cell Front Lower Foot Bracket	Q	1	Single Cell Upper Center Panel Bracket
P	1	Single Cell Front Lower Filler Panel	R	1	Single Cell Front Upper B Pillar Bracket

COMPONENT BOX 570731



O



P



Q



R

## PARTS INCLUDED IN THIS LIST:

### COMPONENT BOX 570731

Item	QTY	Description
22	47	Plastic Nut Caps
23	18	Button Head Hex Drive Screw 1/4"-20 X 3/4"
24	27	Button Head Hex Drive Screw 1/4"-20 X 1"
25	3	Button Head Hex Drive Screw 1/4"-20 X 1-1/4"
26	86	1/4" Flat Washer
27	4	Hex Nut 1/4"-20
28	47	Nylon-Insert Locknut, 1/4"-20
29	2	Button Head Hex Drive Screw M6-1mm X 40mm
30	2	Split Lock Washer M6
31	2	Flat Washer M6
32	1	Shoulder Bolt 3/8"

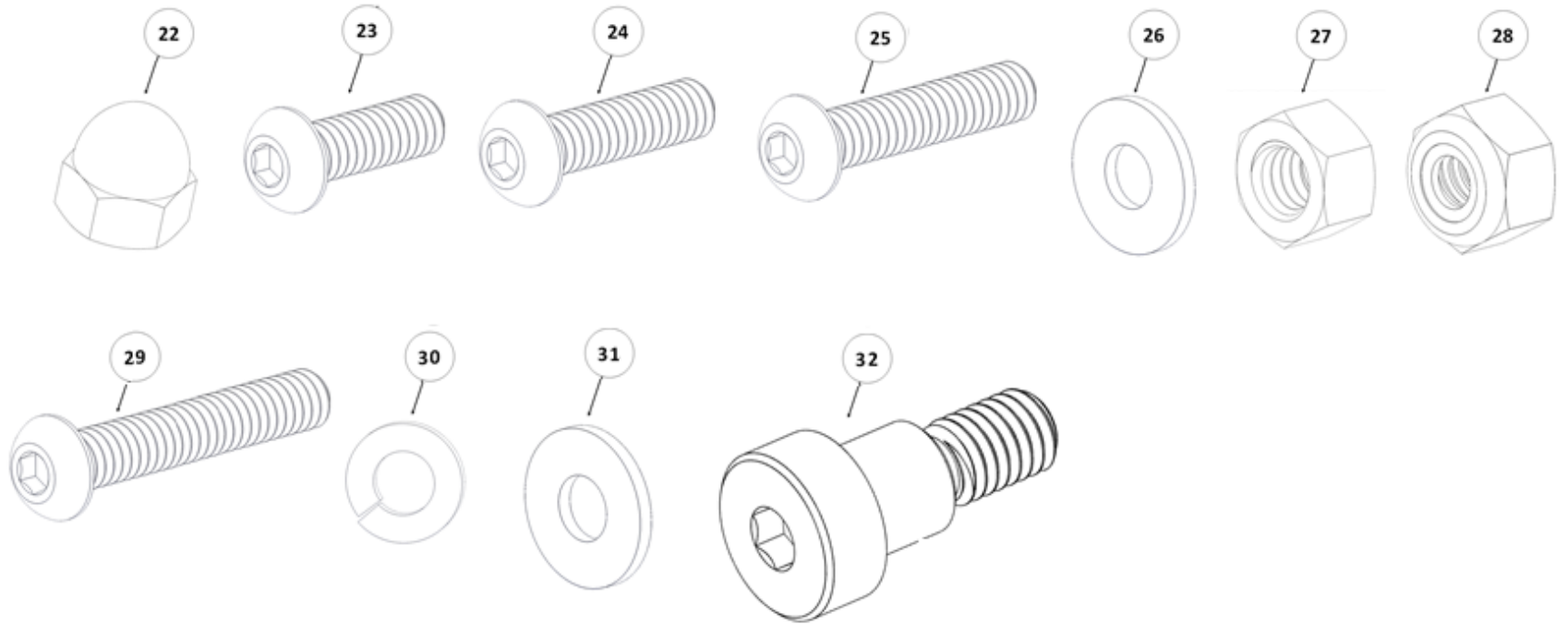



**INSTALLATION INSTRUCTIONS  
 FORD INTERCEPTOR SUV  
 SINGLE CELL WITH 3 POINT  
 BELT; 5707313FEM**



**COMPONENT BOX S12033**

ITEM	QTY	Description	ITEM	QTY	Description
S	1	Single Cell Close Out Panel	Y	1	3 Point Belt
T	1	Single Cell Seat	Z	2	Buckle
U	1	Single Cell Front Lower Panel	AA	1	Buckle Cover
V	1	Single Cell Center Lower Panel	AB	1	Front Belt Buckle Spacer
W	1	Single Cell Front Upper Panel	AC	6	Plastic Panel Fasteners 5/32" (Christmas Tree Fasteners)
X	1	Single Cell Center Upper Panel	AD	1	Vent Cover

COMPONENT BOX SI2033

S

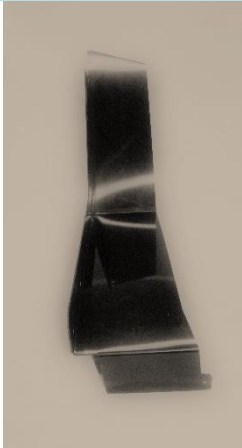

T



U



V



W

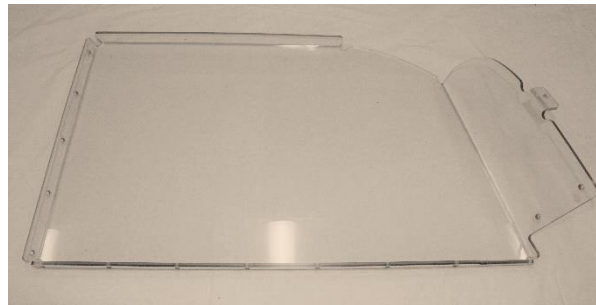

X

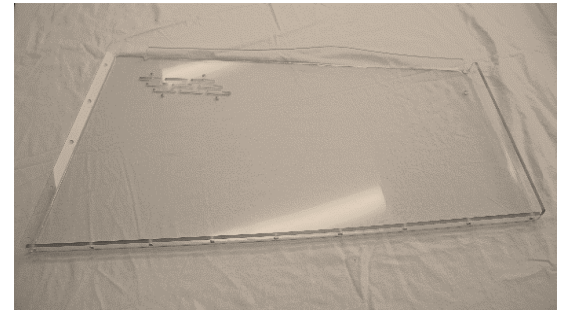



COMPONENT BOX S12033

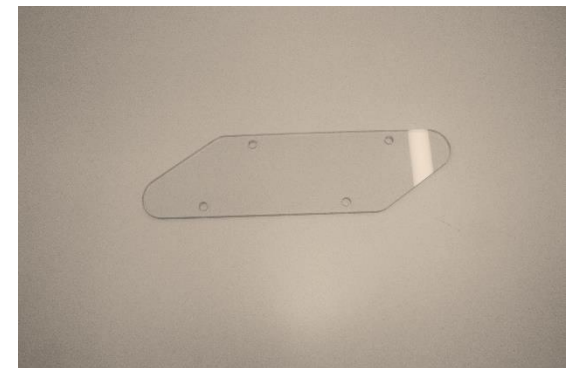
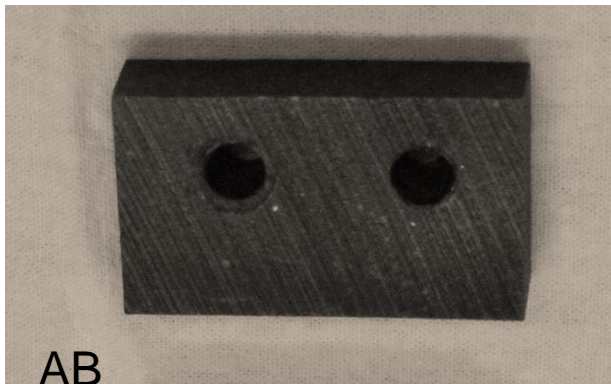
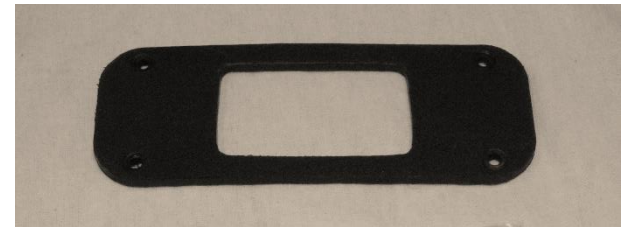





## TOOLS NEEDED FOR INSTALLATION:

- ✓ Inch & Metric Wrench Set
- ✓ Inch & Metric Socket Set
- ✓ Inch & Metric Allen Set
- ✓ T45, T50, & T55 Torx Bit Socket
- ✓ 5/32" & 10MM Hex Bit Socket
- ✓ Ratchet & Ratchet Extension
- ✓ Impact Driver
- ✓ #2 Phillips Screw Driver
- ✓ Tape Measure
- ✓ 24" Level
- ✓ Cutoff Tool
- ✓ Razor Knife

ESTIMATED TIME FOR INSTALLATION: 2.0 – 3.0 Hours

**INSTALLATION INSTRUCTIONS:**

Step 1- Open the rear lift gate, and remove the rear cover from the load compartment, {Fig 1}.

Step 2- Remove the (2) OEM T55 Torx head screws, one per side, using a T55 Torx bit socket. Remove the front cover from the load compartment, {Fig 1}. Retain Torx head screws for later reinstallation.



**INSTALLATION INSTRUCTIONS:**

Step 3- Remove the foam filler from each side of the spare tire well, and the large foam filler from front area of the load compartment, {Fig 2}. There will be (2) OEM Hex head screws to hold a foam filler in, carefully remove the screws before attempting to remove the foam filler. Retain Hex head screws for later reinstallation. Once foam fillers have been removed, remove spare tire and cover. Retain all items for later reinstallation.

Note: Remove the electrical panel from the large foam filler. There may be 2 panels in select models. Retain electrical panel(s).

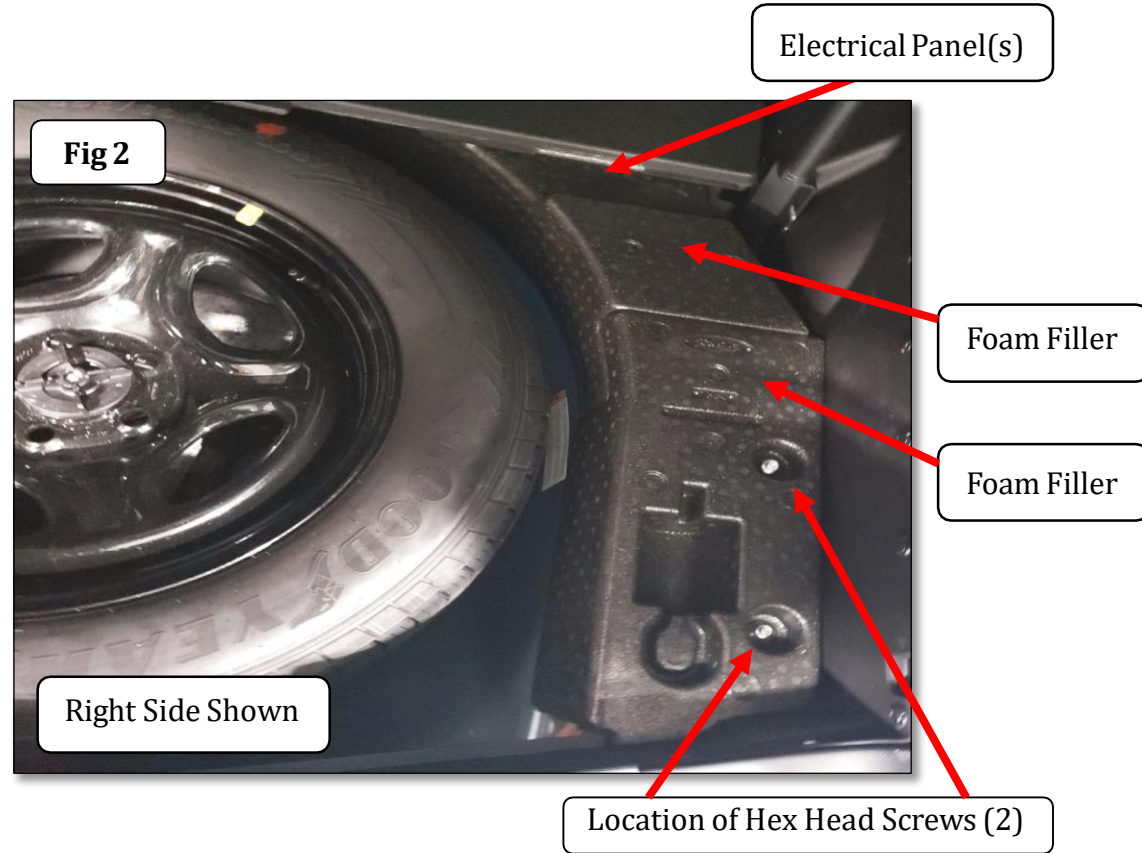

**INSTALLATION INSTRUCTIONS:**

Step 4- Remove 10 OEM nuts (2x- 15MM, 8x- 13MM) and/or screws securing the rear seat sections to the structure frame using a 13MM and 15MM socket. Remove the rear seat sections from rear of the vehicle, {Fig 3}. Using a T45 Torx bit socket remove the Torx head screw, seat belt buckle and wiring from the passenger and middle rear seat section. Secure the (2) seat belt buckles to the seat structural frame using cable tie wraps. Note: The seat belt buckles must be reconnected to the wiring in the same position as when removed from the vehicle.

The OEM passenger and middle rear seat sections will not be reinstalled. The drivers side will be reinstalled later. Handle/disposition accordingly.





**INSTALLATION INSTRUCTIONS:**

Step 5- On passenger side of the vehicle, unsnap the clips and remove the rear door sill plates, {Fig 4}. This will be retained for later reinstallation after modification.

Step 6- On passenger side of the vehicle, pull the rear door rubber weather stripping away from the upper and lower C-pillar plastic covers in order to remove the covers and expose the OEM shoulder belt assembly.

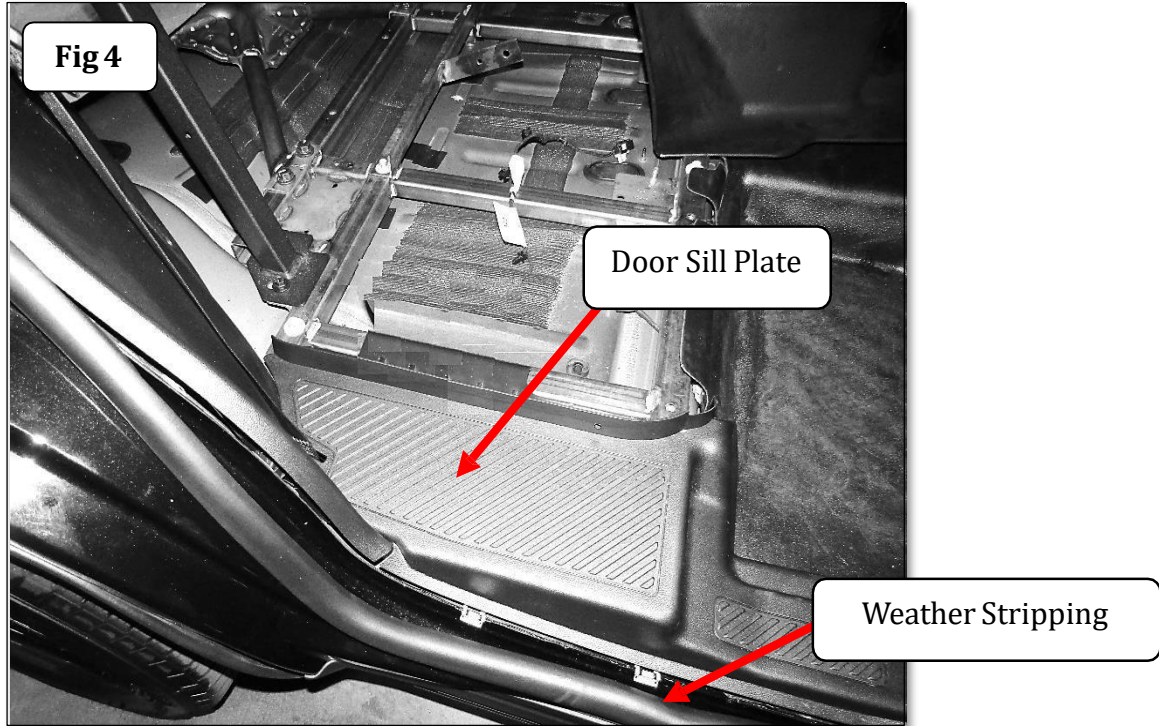

**INSTALLATION INSTRUCTIONS:**

Step 7- On passenger side of the vehicle, pull lower c-pillar plastic cover away from the rear C-pillar.

Upon removal of lower c-pillar plastic cover (1) OEM 5/16" Hex head screw becomes accessible. This screw holds the upper c-pillar plastic cover in place. Remove and retain screw and pull and remove cover for later reinstallation.

This exposes shoulder loop attachment and the retractor, {Fig 5}.

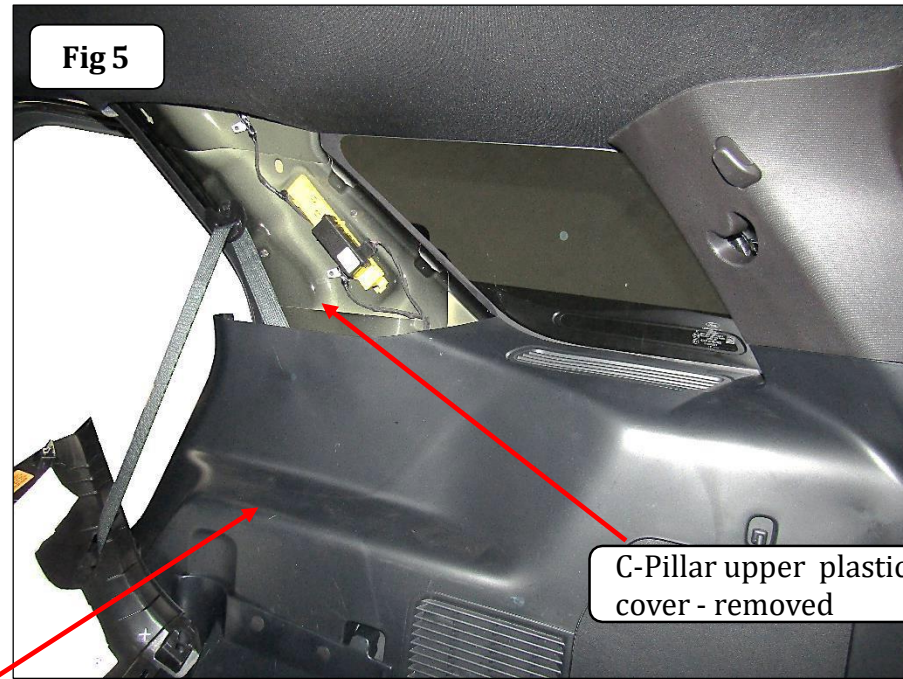

Lower c-pillar plastic cover

C-Pillar upper plastic cover - removed



**INSTALLATION INSTRUCTIONS:**

Step 8- Using a 13MM socket remove the OEM 13MM Hex head screw from the floor anchor mount, {Fig 6}. Remove from anchor and re-install bolt. Unbolt the shoulder loop from the C-Pillar and wrap excess belt up and secure it to the retractor with a zip tie, {Fig 7}. Do not remove the retractor from the vehicle. Simply secure the shoulder belt, Loop attachment, excess belt, and anchor to the retractor so that nothing rattles when the vehicle trim is reattached later.

Note: If retractor is unplugged the electrical system will produce an Error code!

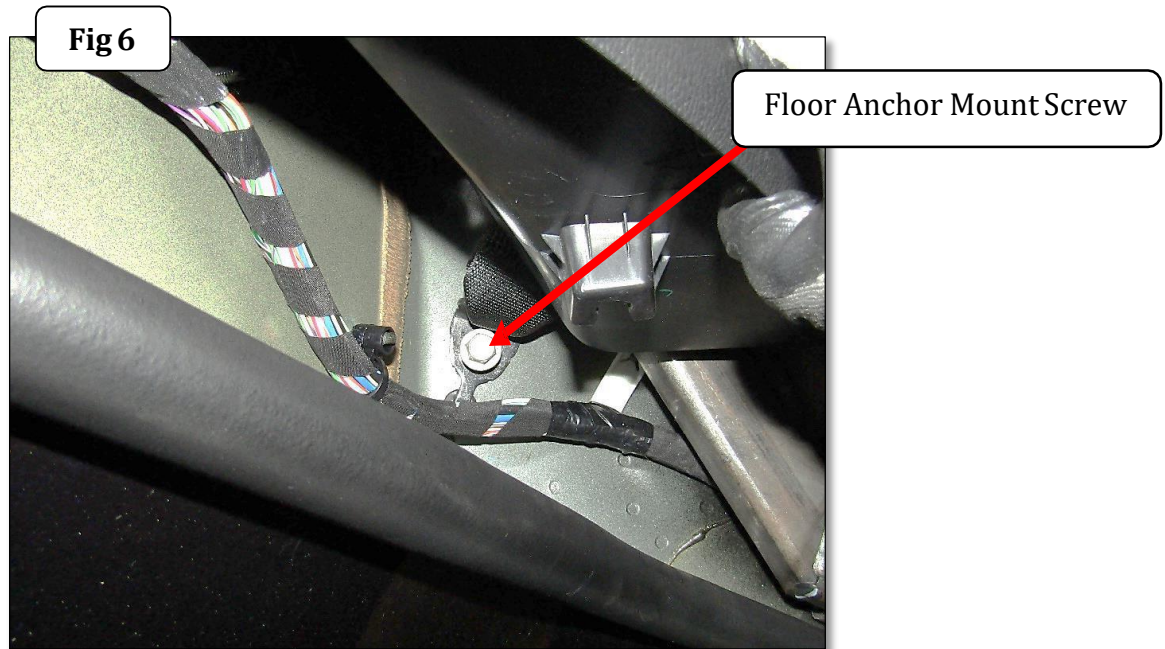



**INSTALLATION INSTRUCTIONS:**

Step 9- Position the rear crossbar in the vehicle, align the hole in each crossbar foot bracket with the OEM rear seat attachment holes in the structural frame and install (1) OEM seat 13MM Hex Head screw per side to secure the crossbar, do not tighten, {Fig 8}. The shape of the foot on the crossbar matches the shape of the pad on the structural frame. Align edges.

Fig 8

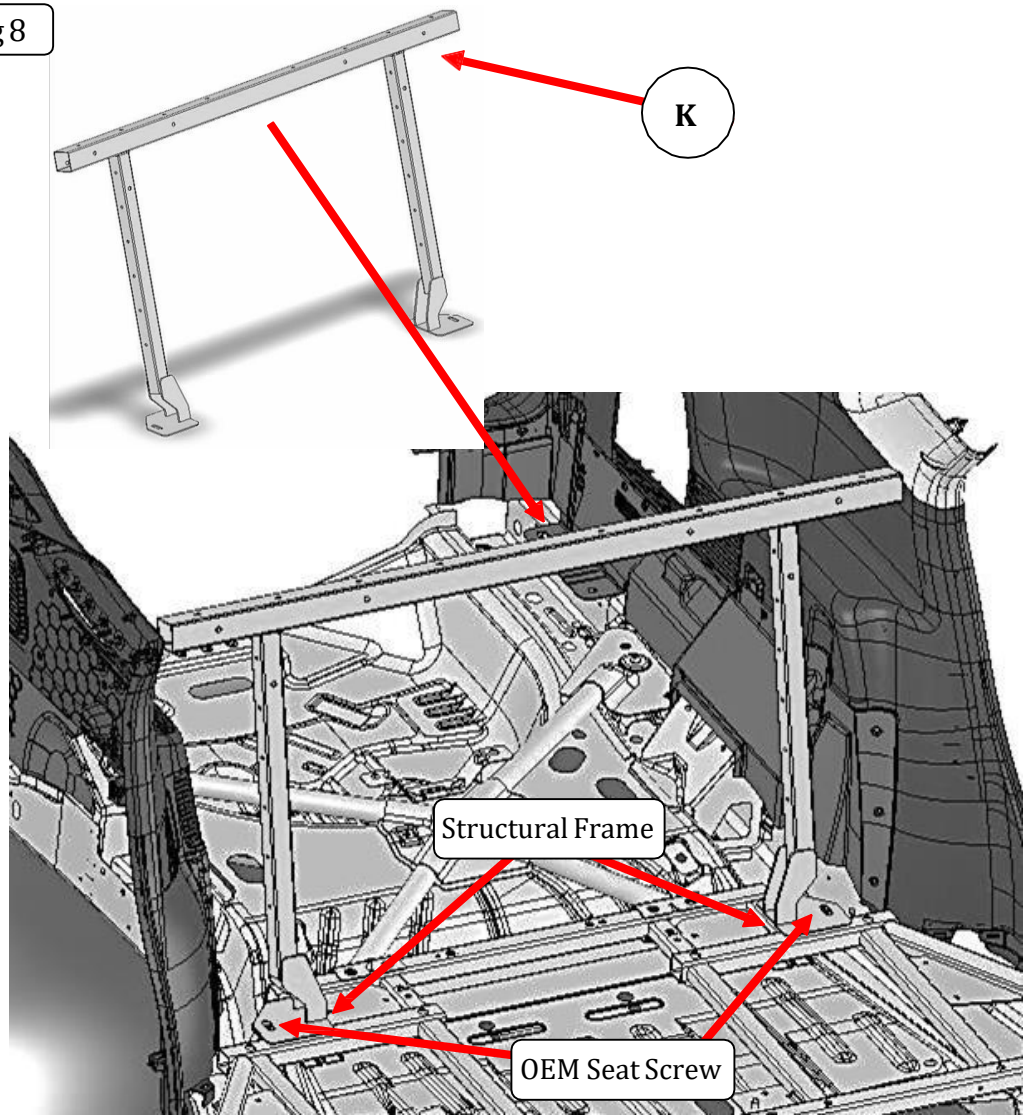

**INSTALLATION INSTRUCTIONS:**

Step 10- Install the center closeout panel first. Align the (2) holes in the top of the center closeout panel with the rivet-nuts installed in the rear crossbar main tube and attach the closeout panel to the crossbar main tube using (2) [Item 3] 1/4" - 20 X 1" Button head hex drive screws, (2) [Item 4] 1/4" lock washers, and (2) [Item 5] 1/4" flat washers, {Fig 9}. Do NOT tighten the screws until all panels have been installed or there may be problems with installation on either side of the vehicle.

Step 11- Next install the left side closeout panel. Align the (4) holes in the side of the closeout panel with the holes in the center closeout panel and the rivet-nuts installed in the vertical tube of the rear crossbar. Attach the left closeout panel and center closeout panel to the vertical tube of the rear crossbar using (4) [Item 3] 1/4" - 20 X 1" Button head screws, (4) [Item 4] 1/4" lock washers and (4) [Item 5] 1/4" flat washers, {Fig 9}. Do NOT tighten the screws until all panels have been installed. Repeat for the right side closeout panel.

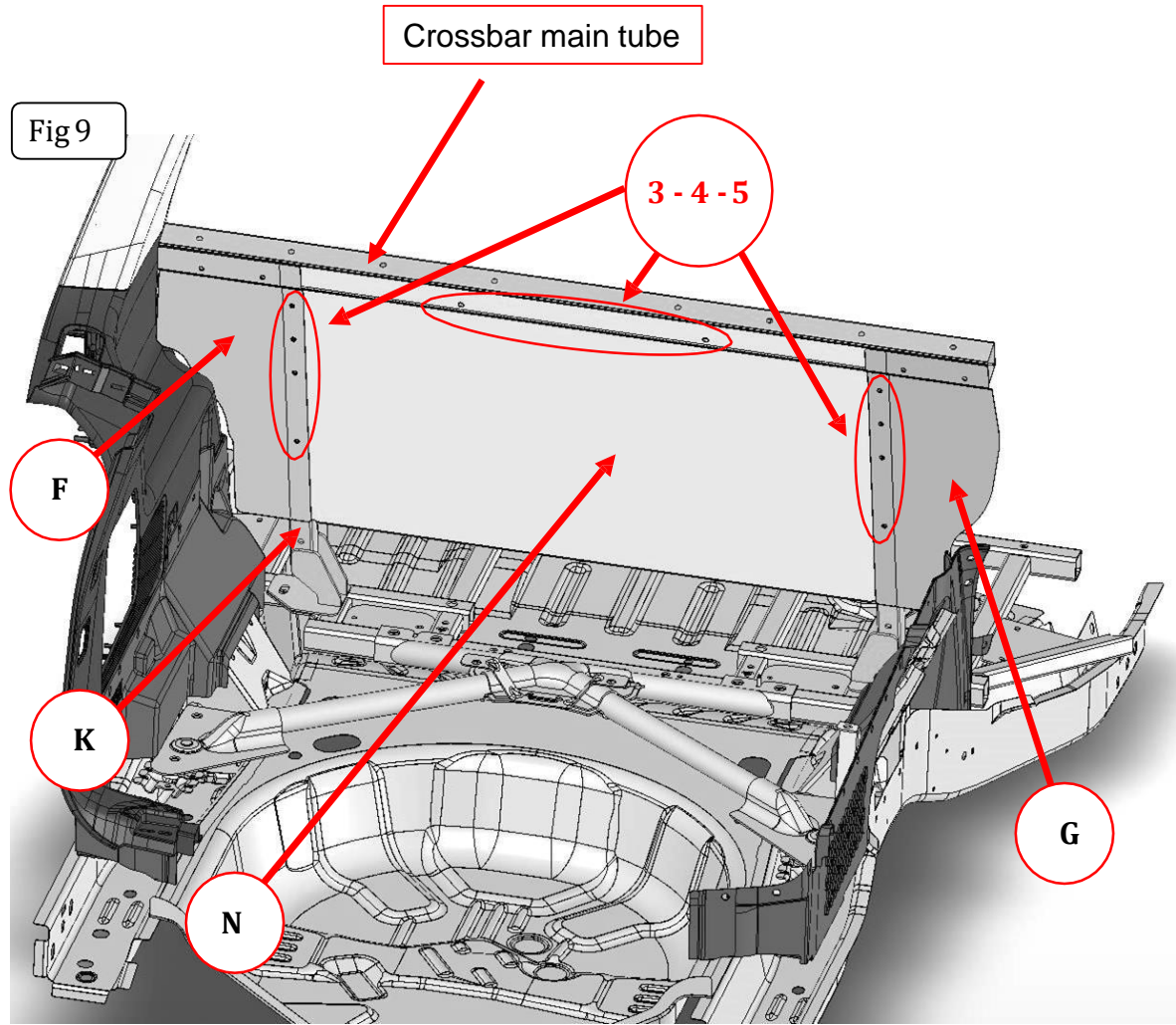

**INSTALLATION INSTRUCTIONS:**

Step 12- On each side of the vehicle, remove (1) OEM 18MM bolt securing the structural frame X-brace using an 18MM socket and ratchet.

Step 15- Align the hole in the foot bracket of each floor strut with the structural frame X-brace attachment hole and install (1) [Item 15] M12 X 1.75MM X 45MM socket head screw, (1) [Item 16] 12MM Split lock washer and (1) [Item 17] 12MM flat washer to secure the X-brace and each floor strut, {Fig 10}. Do not tighten the bolts until all components are seated correctly.

Step 13- Align the two holes in the bracket and attach the opposite end of each floor strut and closeout panel to the crossbar main tube using (2) [Item 3] ¼" X 1" button head screws, (2) [Item 4] ¼" lock washers, and (2) [Item 5] ¼" flat washers, {Fig 10}. Do not tighten the screws until all components are seated correctly.

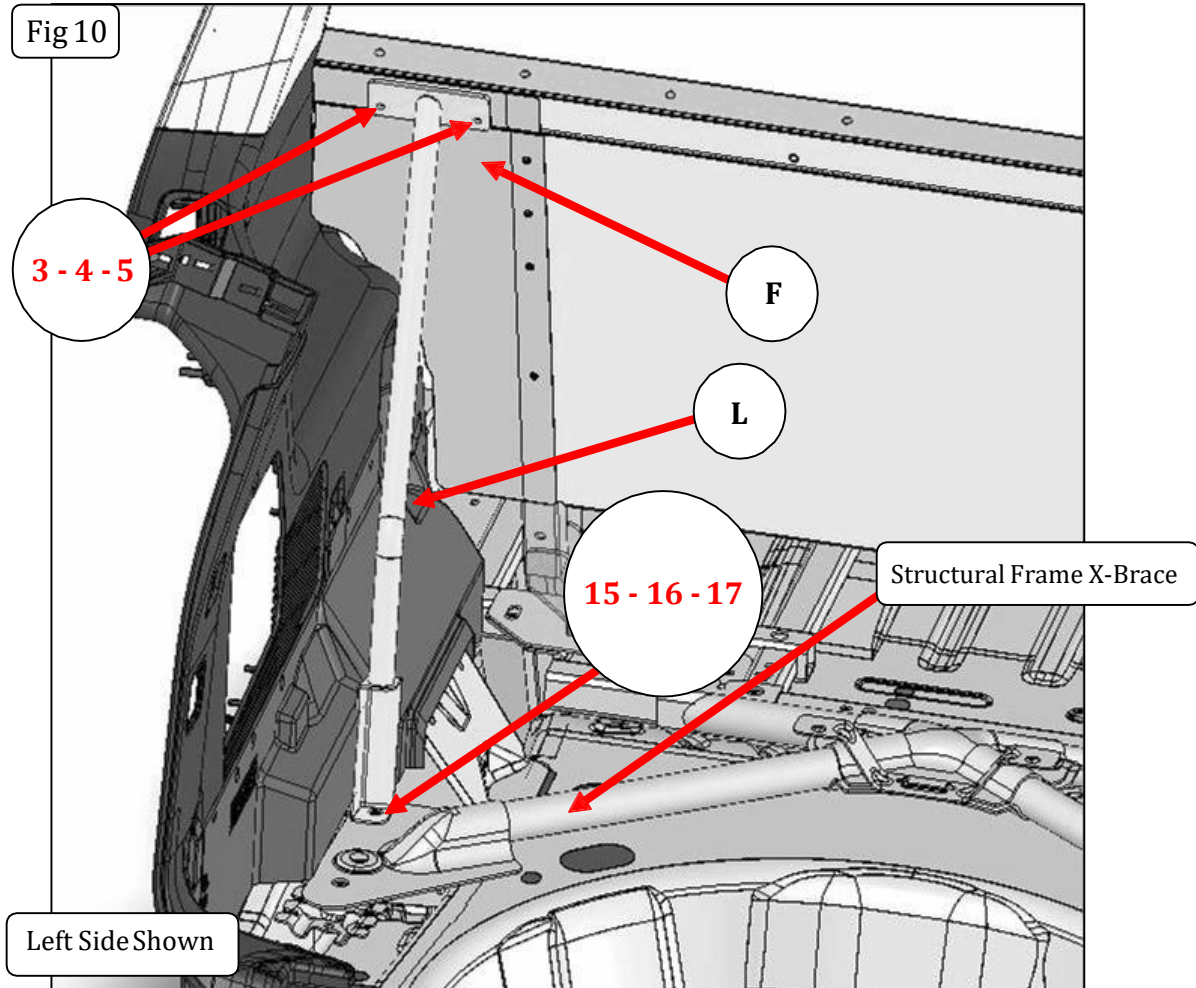



**INSTALLATION INSTRUCTIONS:**

At this time square the rear crossbar in the vehicle. Measure from the bottom outside corner of each end of the rear crossbar main tube to the B-Pillars as shown, (Fig 11). Ensure the distances are the same (39-1/2"). Securely tighten all previously installed fasteners, being sure to maintain this dimension on both sides.

Fig 11

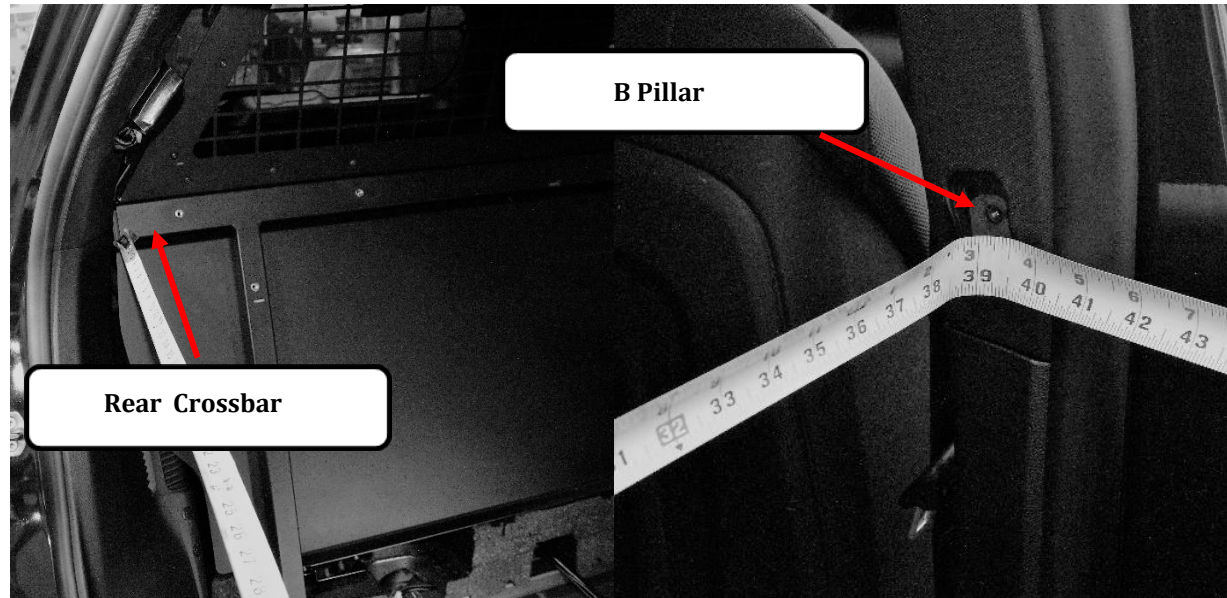

**INSTALLATION INSTRUCTIONS:**

Step 14- Loosen the (7) nuts and screws on each side of the rear screen window assembly. Remove the protective film from the upper filler panels before installing. Align the three slots with the screws and slide the polycarbonate upper filler panel into position between the screen window frame and the window frame support bracket then retighten the nuts and screws, {Fig 12}. Repeat for the left side.

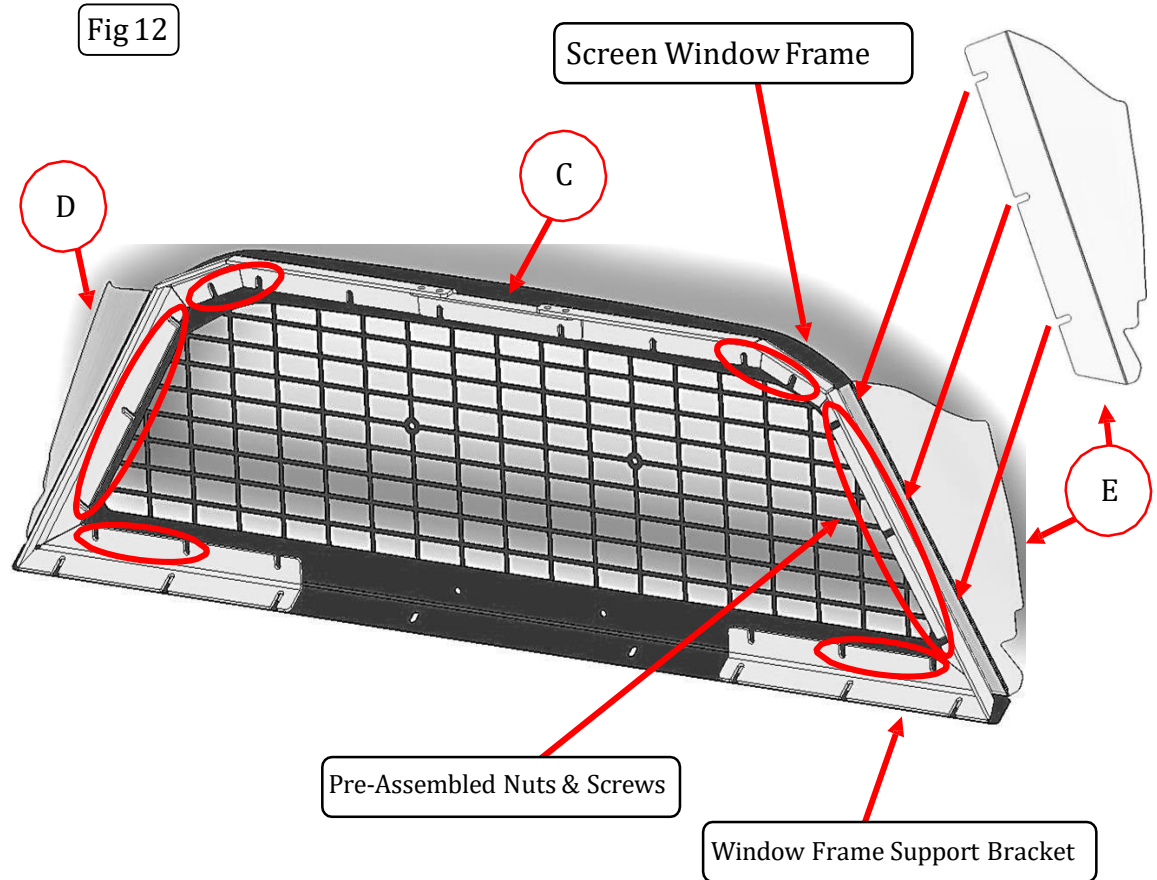

**INSTALLATION INSTRUCTIONS:**

Step 15- With assistance place the rear screen window and upper filler panel assembly through the cargo area of the vehicle. Attach the window frame assembly to the rear crossbar main tube using (8) [Item 3] ¼" - 20 X 1" button head screws, (8) [Item 4] ¼" lock washers, and (8) [Item 5] ¼" flat washers, {Fig 13}. Securely tighten the screws.

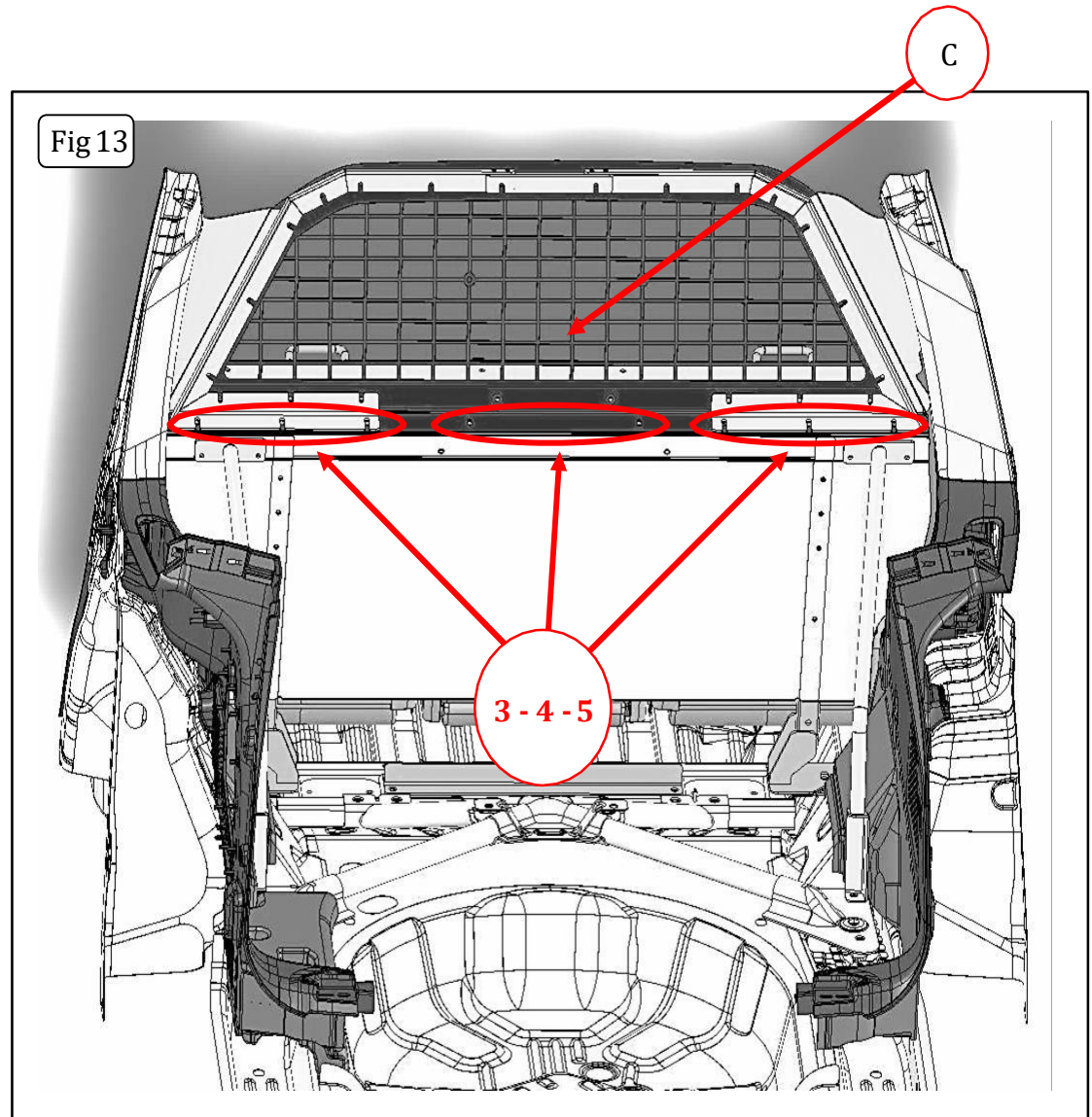



**INSTALLATION INSTRUCTIONS:**

Step 16- Remove the Passenger Side B Pillar Grab handle from the vehicle and-Install [Item R], Single Cell Front Upper B Pillar Bracket with (1) [Item 29] Button Head Hex Drive Screw M6 X 40MM, (1) [Item 30] M6 Split Lock Washer, (1) [Item 31] M6 Flat Washer . Finger tighten only until the bracket can hold itself in place, {Fig.14}.

Fig 14

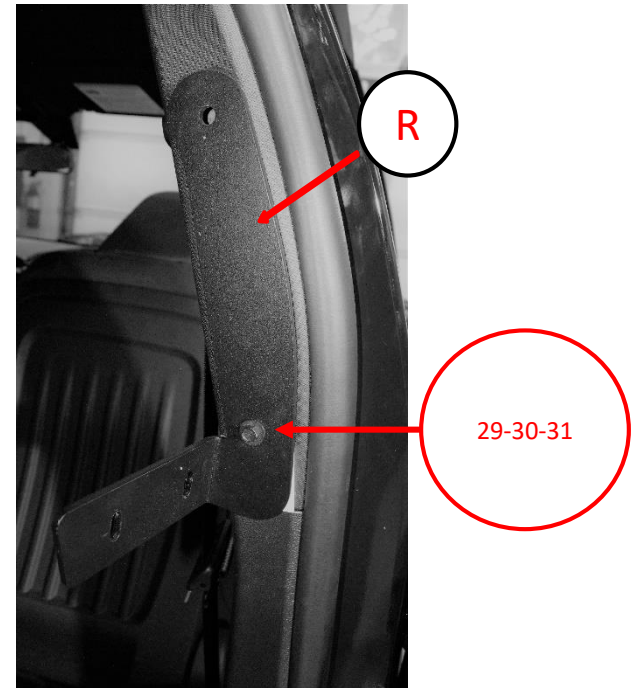

Step 17-Loosen the OEM rear inboard bolt from the front Passenger seat base, but do not remove it. Remove the OEM rear outboard bolt from the front Passenger seat base (retain this bolt-it will be used in Step 22, {Fig 15}.

Fig 15

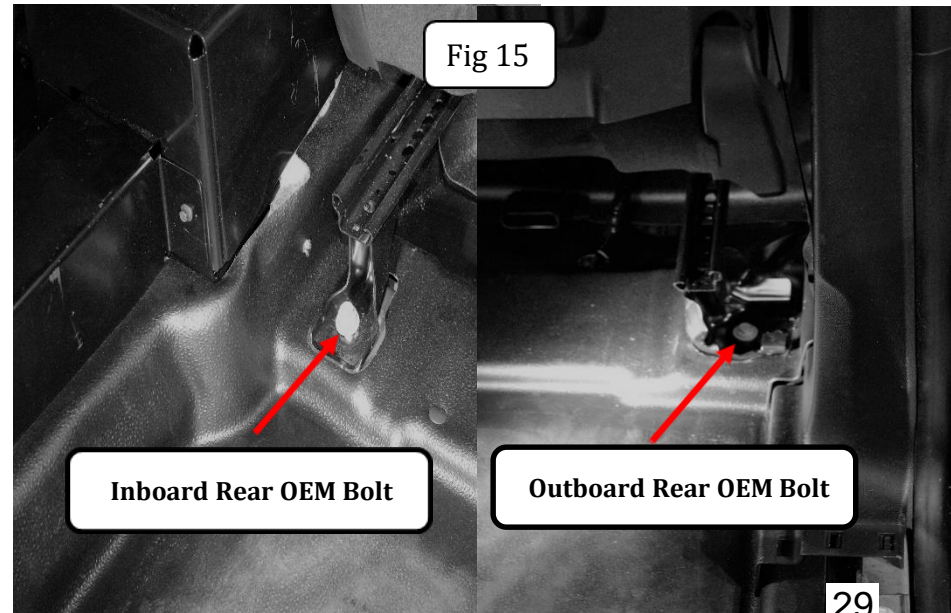



**INSTALLATION INSTRUCTIONS:**

Step 18- Install [Item O], Single Cell Front Lower Foot Bracket under the rear base of the Front Passenger seat. Fasten using the Outboard Rear OEM Bolt. Finger tighten only, {Fig.16}. At this time securely tighten the Inboard Rear OEM Bolt.

Fig 16

Outboard Rear OEM Bolt

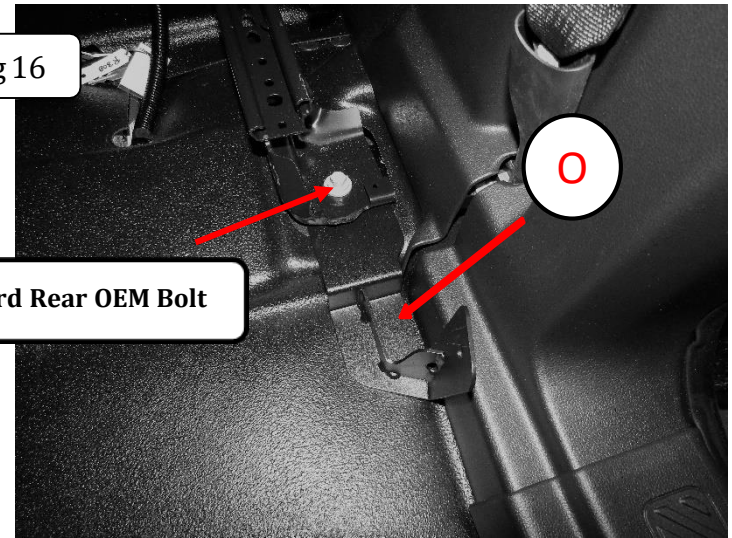

Step 19-Place a 24" level on the OEM structural frame in the approximate location, parallel to the structural frame member, shown in, {Fig 17}. Note the position of the bubble within the site gauge. [Item B] The Seat Adapter Bracket will need to be installed to the same level position; so it is parallel to the OEM structural frame.

Fig 17

24" Level

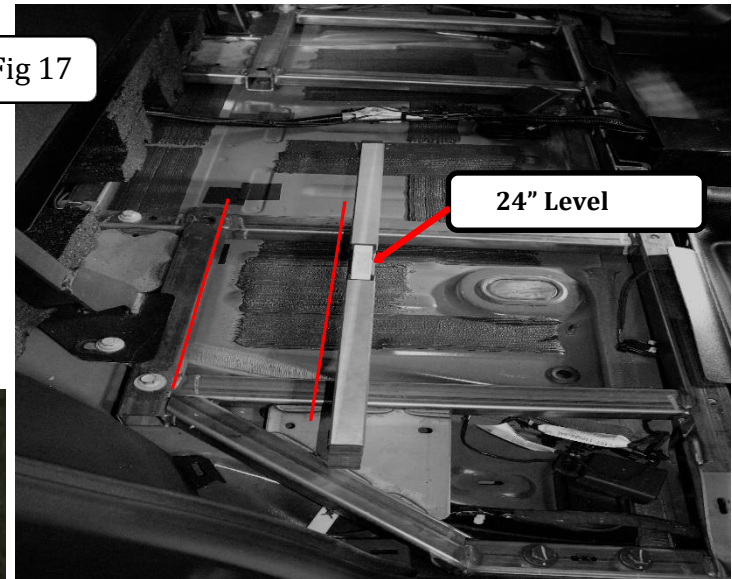

Sample site gauge

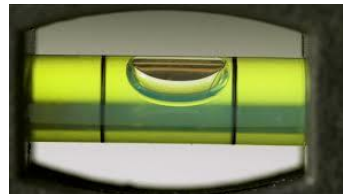

**INSTALLATION INSTRUCTIONS:**

Step 20- Install [Item B], Seat Adapter Bracket with (1) [Item 3] Button Head Hex Drive Screws, 1/4" – 20 X 1", (1) [Item 4] Lock Washer 1/4" and (1) [Item 5] Flat Washer 1/4", {Fig 18}. Finger tighten only.

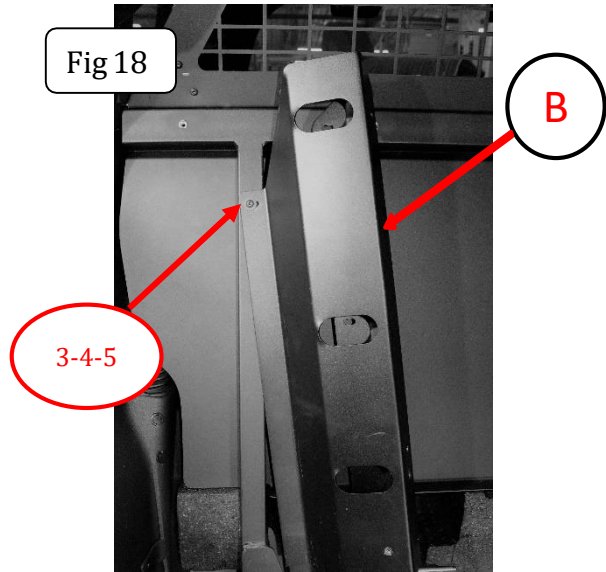

Step 21-Rotate [Item B], Seat Adapter Bracket into position. Using a 5/32" Hex drive socket with extension to fasten with (3) [Item 3] Button Head Hex Drive Screws, 1/4" – 20 X 1", (3) [Item 4] Lock Washer 1/4" and (3) [Item 5] Flat Washer 1/4". Finger tighten only, {Fig 19}.

Note:  
Final alignment will be done with the installation of [Item U] Single Cell Center Lower Panel.

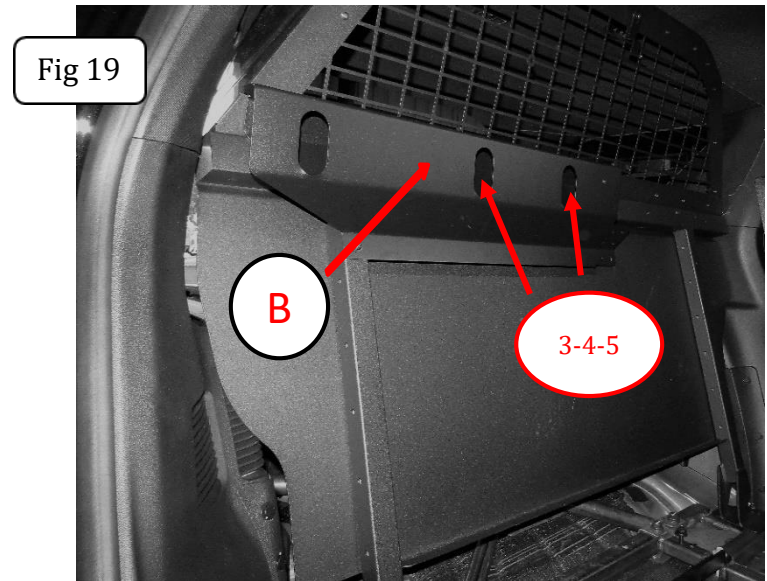

**INSTALLATION INSTRUCTIONS:**

Step 22- Remove factory 13mm bolts and use them to install [Item J], Center Belt Bracket, with a #13mm socket and Impact wrench. (2) OEM bolts, {Fig 20}. Tighten securely.

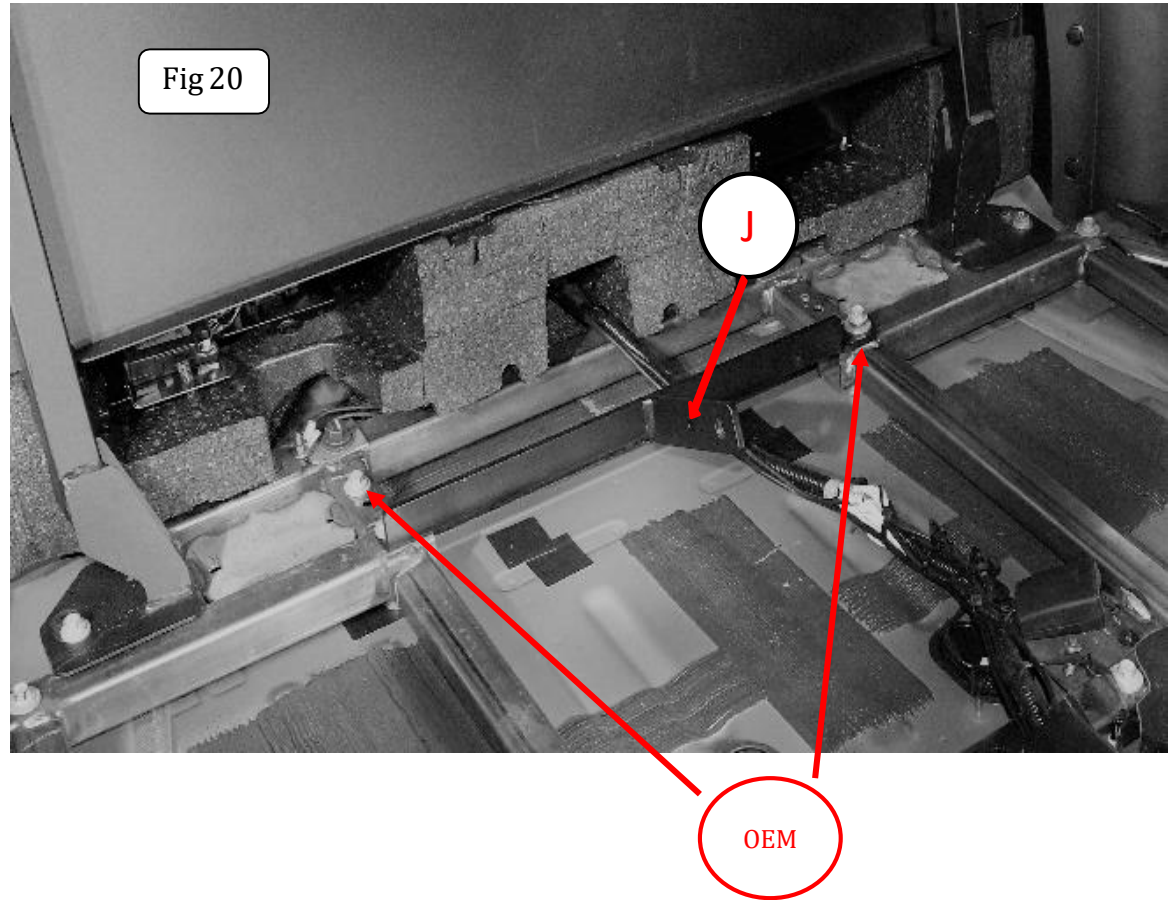

**INSTALLATION INSTRUCTIONS:**

Step 23- Attach (1) [Item Z] Buckle to [Item I] Seat Belt Bracket using (2) [Item 3] Button Head Hex Drive Screws, ¼" – 20 X 1", (2) [Item 5] Flat Washer ¼" and (2) [Item 6] Nylon-Insert Locknut, ¼-20", {Fig 21}.

**Note:** Fully tighten the button head screws and nylon lock nuts, then loosen the lock nuts a full turn to allow the buckle to slide freely front to back and tilt slightly from side to side.

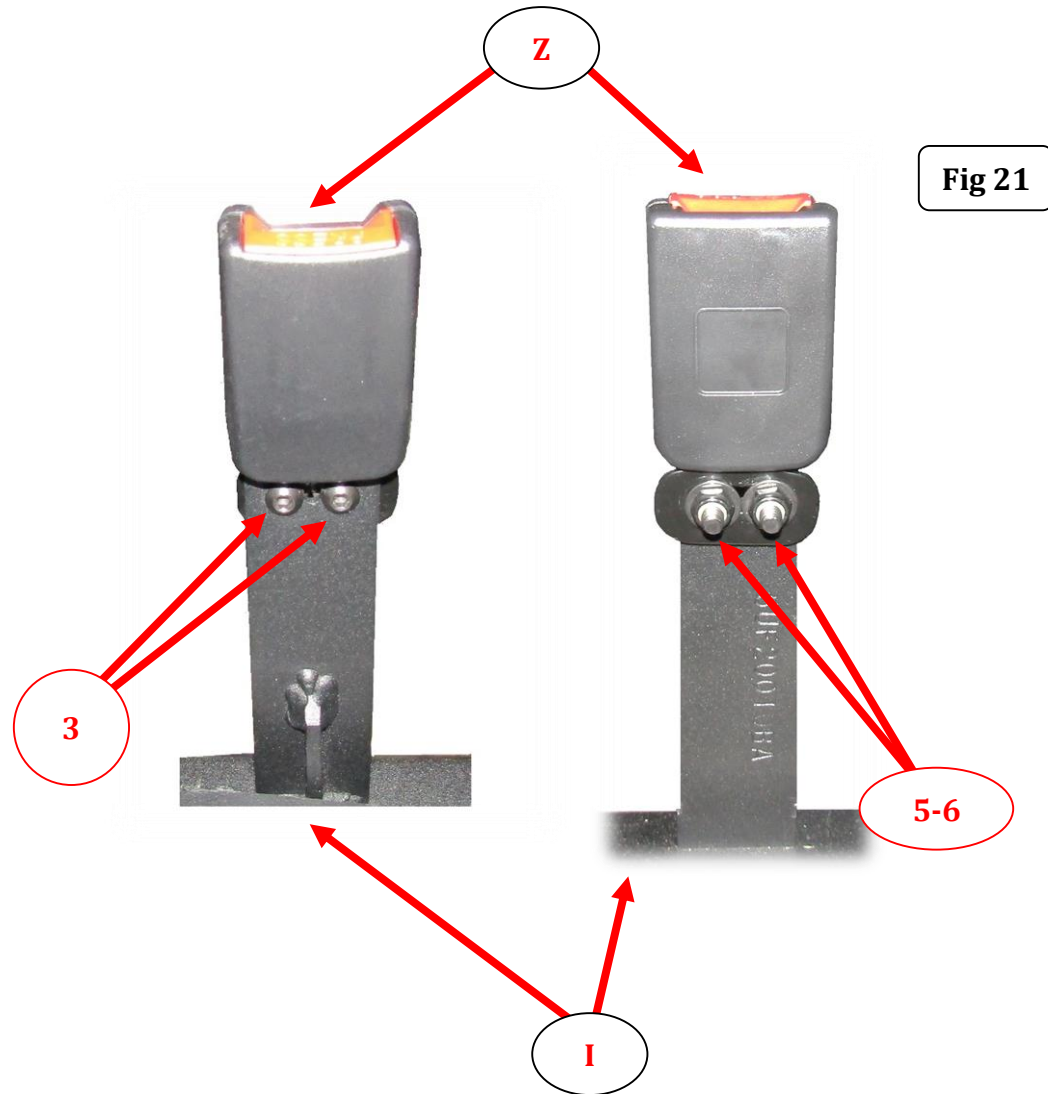



**INSTALLATION INSTRUCTIONS:**

Step 24- Align the holes in the right side outer seat belt bracket with the holes in the structural frame and install (2) [Item 7] Hex Head Screws 5/16" – 18 X 1" (2) [Item 8] 5/16" flat washers and (2) [Item 9] 5/16" serrated flange locknuts to secure the outer seat belt bracket to the structural frame, {Fig 22}. Securely tighten the nuts and screws.

Note: The plunger is on the outboard side and the slot is inboard.

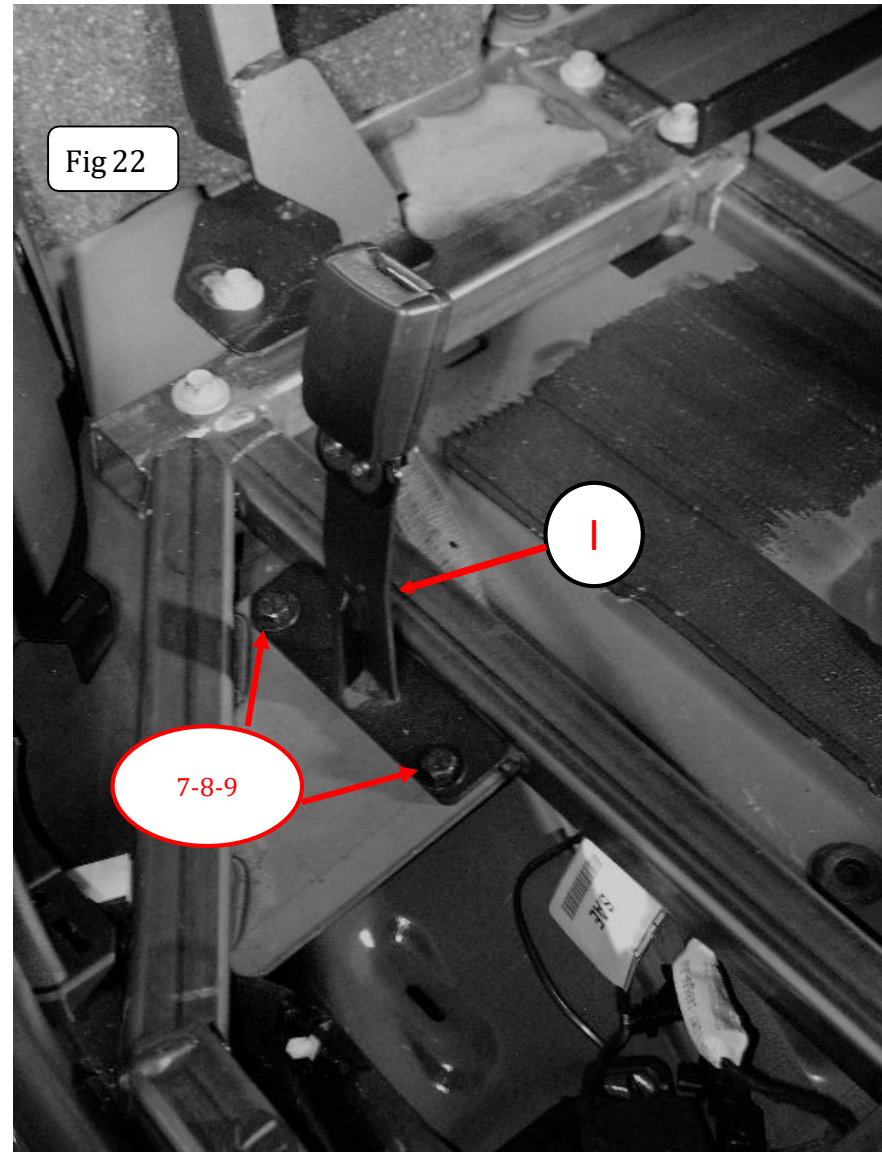

**INSTALLATION INSTRUCTIONS:**

Step 25- Perform final alignment of [Item B] Seat Adapter Bracket.

Place [Item V], Single Cell Center Lower Panel in approximate position shown in {Fig 23}, ensuring it is flat on the floor, so that the spacing between [Item V] and [Item B] is the uniform. {Fig 24}. Snug inner most fastener.

Snug this fastener first once the spacing is uniform.

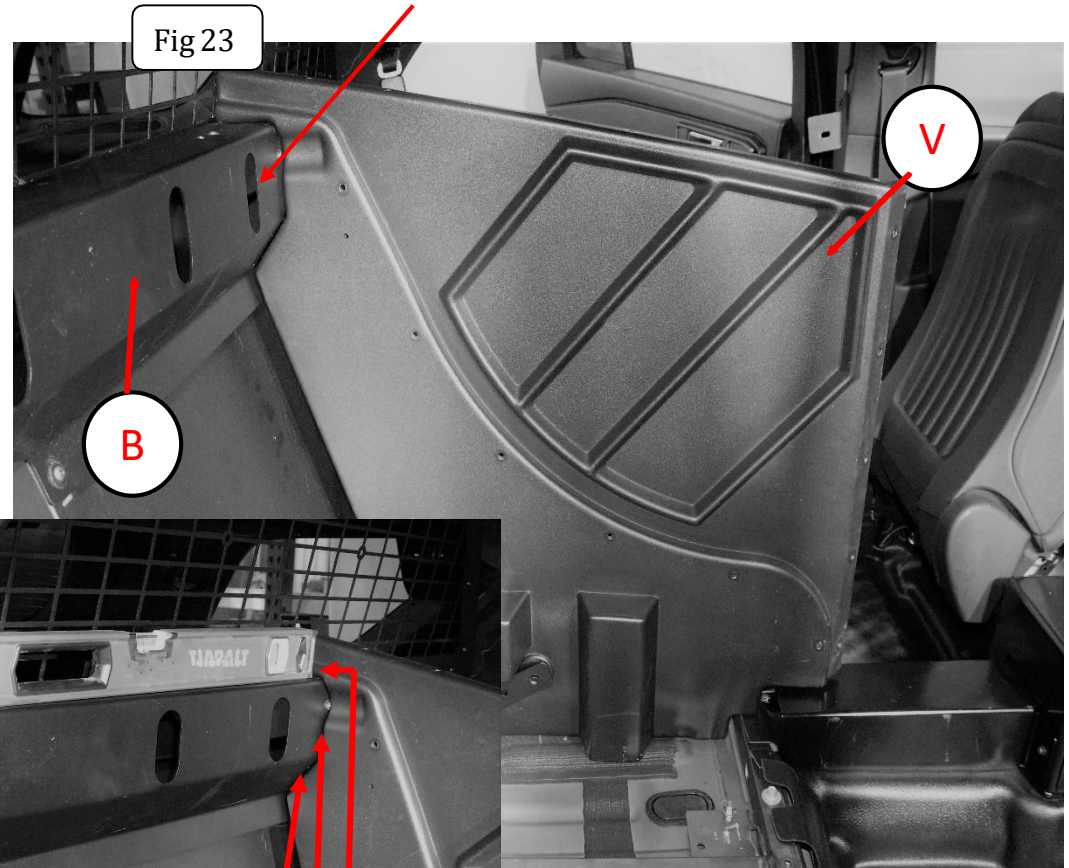

Place a 24" level on [Item B] in the approximate location as shown in {Fig 24}. Adjust level of [Item B] to the noted site gauge bubble location from (Step 19). This will insure [Item B] is parallel with the structural frame. Once it is- Securely tighten all the fasteners attaching [Item B] to the vehicle

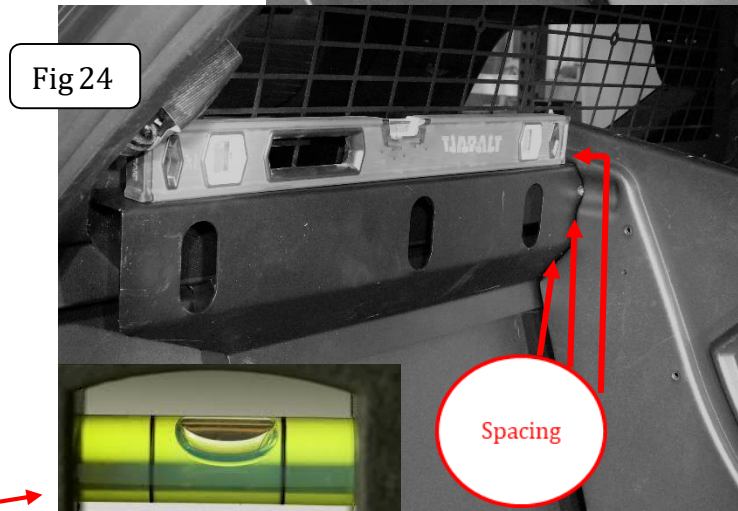

Sample site gauge

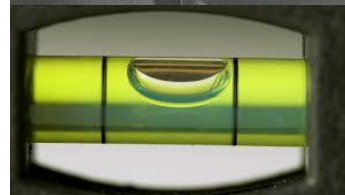

**INSTALLATION INSTRUCTIONS:**

Step 26- Install [Item P], Single Cell Front Lower Filler Panel to [Item R], Single Cell Front Upper B Pillar Bracket. Fasten using (2) [Item 23] Button Head Hex Drive Screws, 1/4" – 20 X 3/4", (4) [Item 26] Flat Washer 1/4" and (2) [Item 28] Nylon-Insert Locknut, 1/4-20" Finger tighten only, {Fig 25}. Note: Bolt Head is seen. Place Nut in unexposed side.

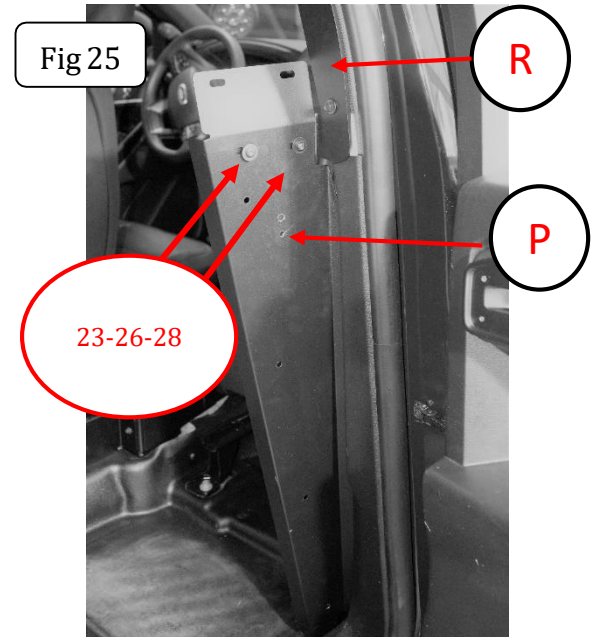

Step 27- Install [Item U] Single Cell Front Lower Panel to [Item P], Single Cell Front Lower Filler Panel. Fasten using (4) [Item 23] Button Head Hex Drive Screws, 1/4" – 20 X 3/4", (8) [Item 26] Flat Washer 1/4" and (4) [Item 28] Nylon-Insert Locknut, 1/4-20"

Lower fastener goes through the [Item U] Single Cell Front Lower Panel, [Item P], Single Cell Front Lower Filler Panel and [Item O], Single Cell Front Lower Foot Bracket.

Finger tighten only, {Fig 26}. Note: Bolt Head is seen. Place nut in unexposed side.

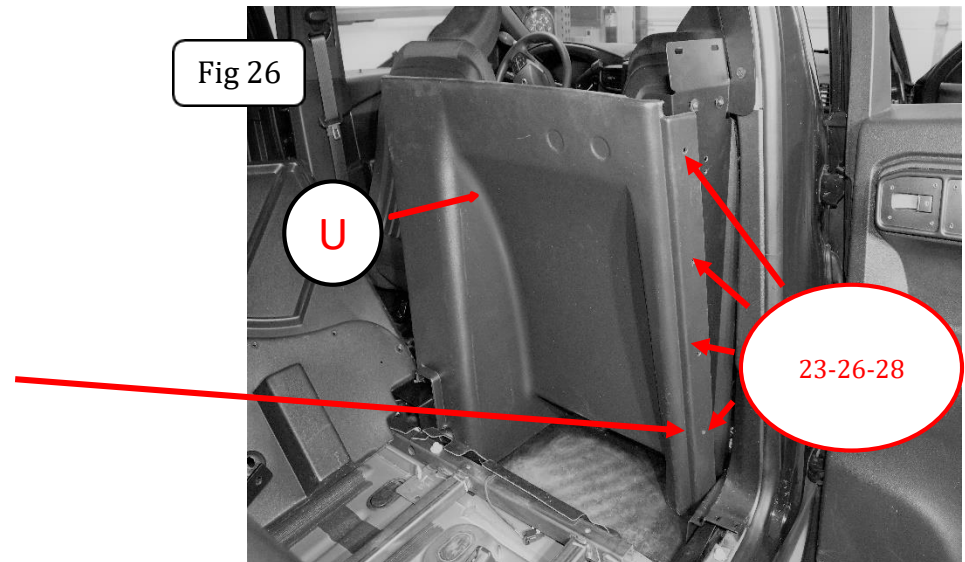



**INSTALLATION INSTRUCTIONS:**

Step 28- Fasten [Item V], Single Cell Center Lower Panel to [Item U], Single Cell Front Lower Panel, {Fig 27}.

Fasten using (5) [Item 23] Button Head Hex Drive Screws, ¼" – 20 X ¾", (10) [Item 26] Flat Washer ¼" and (5) [Item 28] Nylon-Insert Locknut, ¼-20" Finger tighten only. Note: Feed bolt and washer from the front of the vehicle to the rear. One washer will be on the bolt side and one washer will be on the nut side, {Fig 28}.

Fig 27

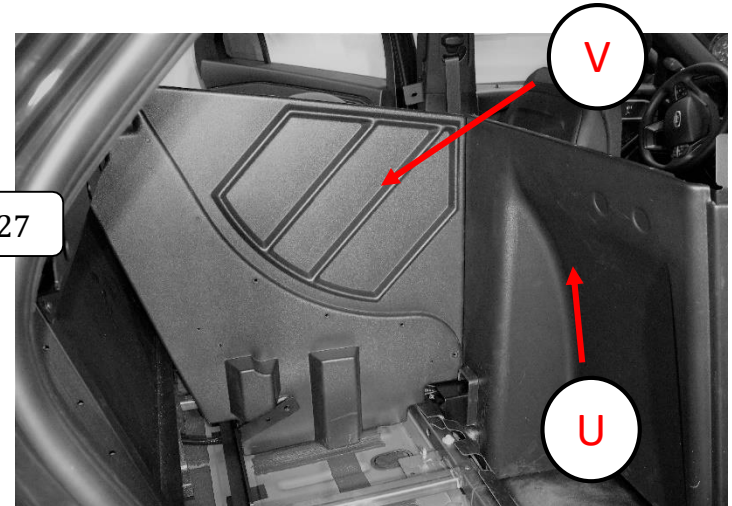
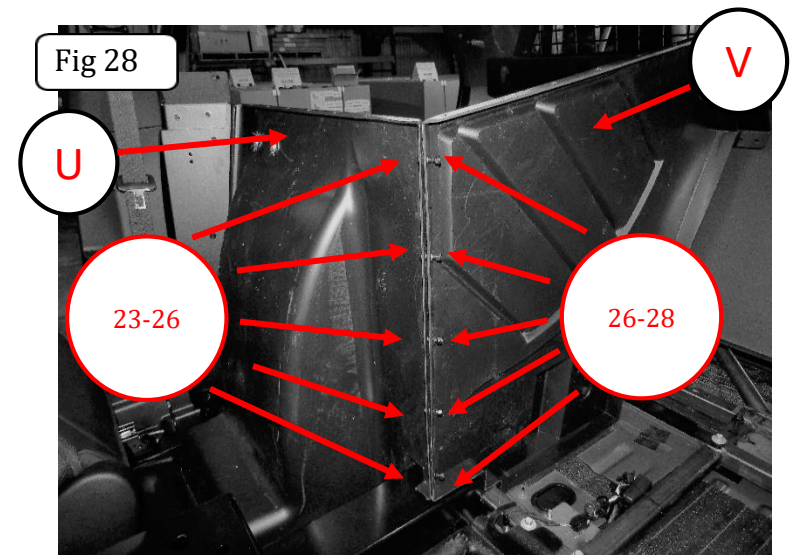

Fig 28



**INSTALLATION INSTRUCTIONS:**

Step 29- Install [Item X] Single Cell Center Upper Panel to the top of [Item V] Single Cell Center Lower Panel, {Fig 29}. Remove protective film from [Item X].

Fig 29

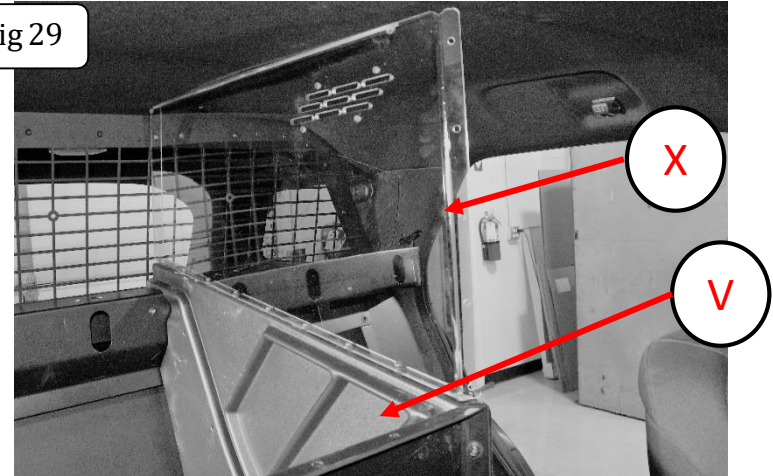
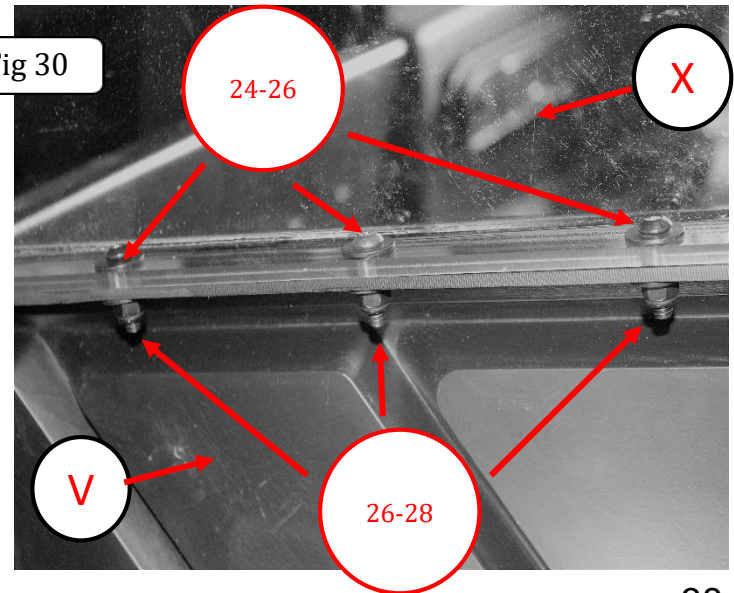

Fig 30



Fasten using (9) [Item 24] Button Head Hex Drive Screws, ¼” – 20 X 1”, (18) [Item 26] Flat Washer ¼” and (9) [Item 28] Nylon-Insert Locknut, ¼-20” Finger tighten only. Note: Feed bolt and washer down through Install [Item W] Single Cell Center Upper Panel and [Item V] Single Cell Center Lower Panel then fasten with one washer and nut, {Fig 30}. Finger tighten only.

**INSTALLATION INSTRUCTIONS:**

Step 30- Install [Item W] Single Cell Front Upper Panel, {Fig 31}, Remove protective film from [Item W].

Insert the first fastener: (1) [Item 24] Button Head Hex Drive Screws, ¼” – 20 X 1”, (2) [Item 26] Flat Washer ¼” and (1) [Item 28] Nylon-Insert Locknut, ¼-20” In the top hole of both [Item W] Single Cell Front Upper Panel and [Item X] Single Cell Center Upper Panel, {Fig 32}. Again, bolt and washer and then washer and nut. Finger tighten only.

Place the second fastener through [Item W] Single Cell Front Upper Panel and the top hole in [Item R] Single Cell Front Upper B Pillar Bracket using (1) [Item 29] Button Head Hex Drive Screw M6 X 40MM, (1) [Item 30] M6 Split Lock Washer, (1) [Item 31] M6 Flat Washer. Finger tighten only, {Fig 32a}.

Fig 31

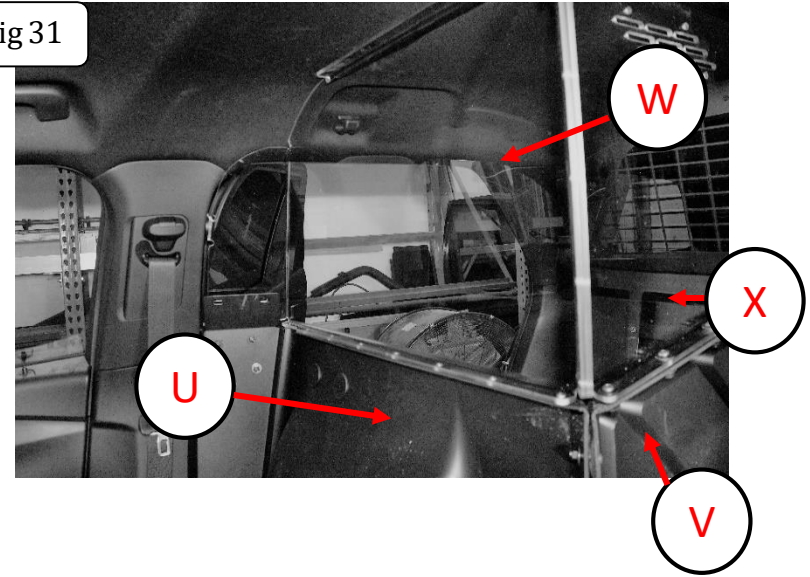

Fig 32

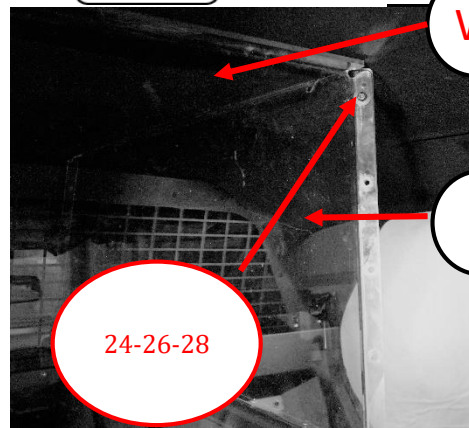
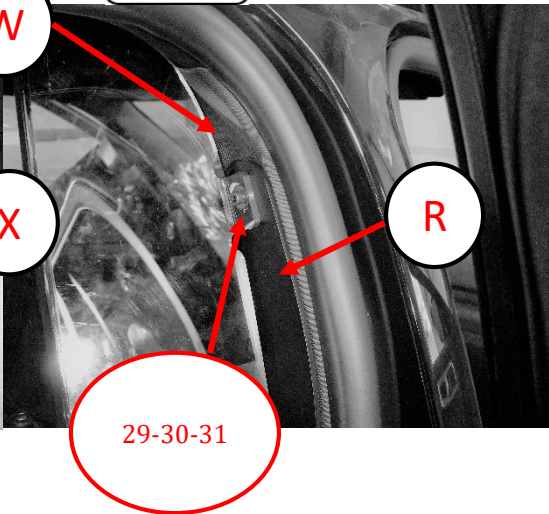

Fig 32a





**INSTALLATION INSTRUCTIONS:**

Step 31- Install the remaining fasteners into [Item W] Single Cell Front Upper Panel and [Item X], using (5) [Item 24] Button Head Hex Drive Screws, 1/4" – 20 X 1", (10) [Item 26] Flat Washer 1/4" and (5) [Item 28] Nylon-Insert Locknut, 1/4-20"; starting at the bottom hole of [Item W] and [Item X] work upwards fastening the panels together. {Fig 33.} Then using (7) [Item 20] Button Head Hex Drive Screws, 1/4" – 20 X 1", (14) [Item 22] Flat Washer 1/4" and (7) [Item 24] Nylon-Insert Locknut, 1/4-20"; work outward from the farthest inbound hole and fasten [Item W] and [Item U] together, {Fig 33} Finger tighten only

Step 32- Install fasteners: (2) [Item 23] Button Head Hex Drive Screws, 1/4" – 20 X 3/4", (4) [Item 26] Flat Washer 1/4" and (2) [Item 28] Nylon-Insert Locknut, 1/4-20" into [Item W] Single Cell Front Upper Panel and [Item P] Single Cell Front Lower Filler Panel, {Fig 34}. Again, bolt and washer and then washer and nut. Finger tighten only.

Fig 33

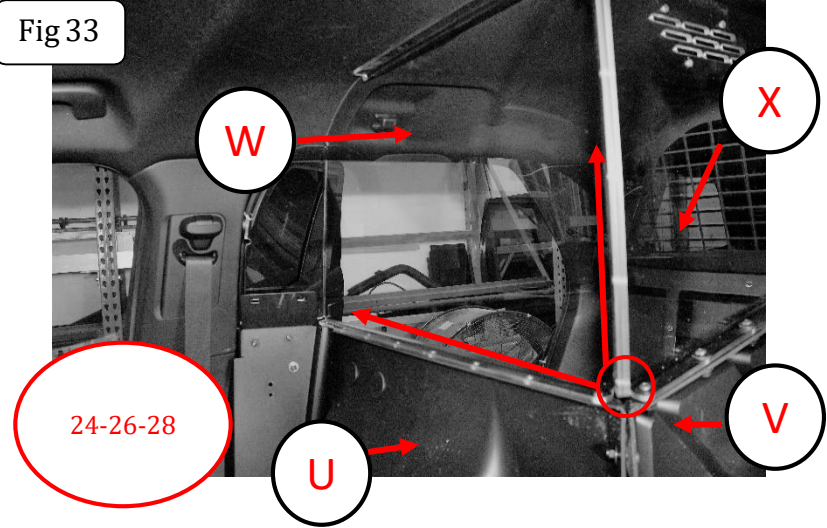

Fig 34





**INSTALLATION INSTRUCTIONS:**

Step 33- A section of the passenger side rear door sill plate must be removed to allow clearance for the molded seat and outer seat belt bracket. Cut on dotted red line in {Fig 35} to remove the section from the rear door sill plate. Reinstall the rear door sill plate.

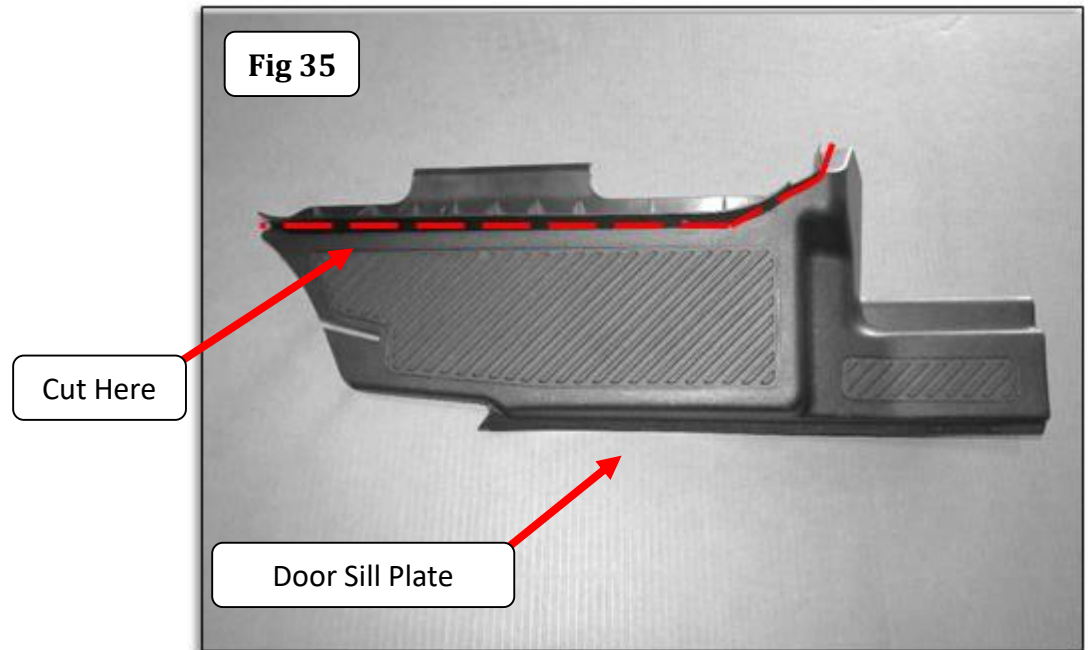

**INSTALLATION INSTRUCTIONS:**

Step 34- Place [Item T] Single Cell Seat into the vehicle. Do not yet attempt to locate the seat into final position. Take [Item Y], 3 Point Belt, and feed the anchor plate of the waist belt end through the seat belt slot at the inboard side of the seat, {Fig 36}.

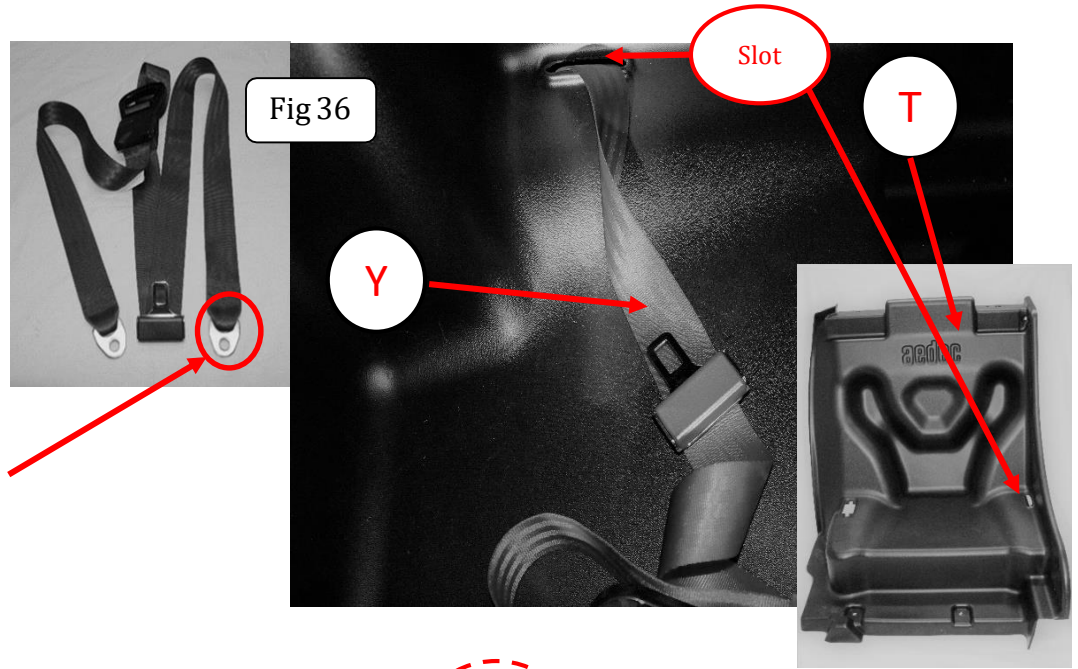

Step 35- This process will require two people. Pull the top of the seat {T} forward to expose the mounting hole for the belt located in Panel {V} {Fig 37}. From the Driver Side of the rear seat compartment, opposite side of image. Insert (1) [Item 10] Hex Head Cap Screw 1/2"-13 x 2", (1) [Item 11] Flat Washer 1/2" through [Item V] and [Item J], and Anchor plate of [Item Y] then fasten using (1) [Item 11] Flat Washer 1/2" and (1) [Item 12] Nylon-Insert Locknut, 1/2" - 13. A 3/4" socket and 3/4" wrench will be required. Tighten Securely.

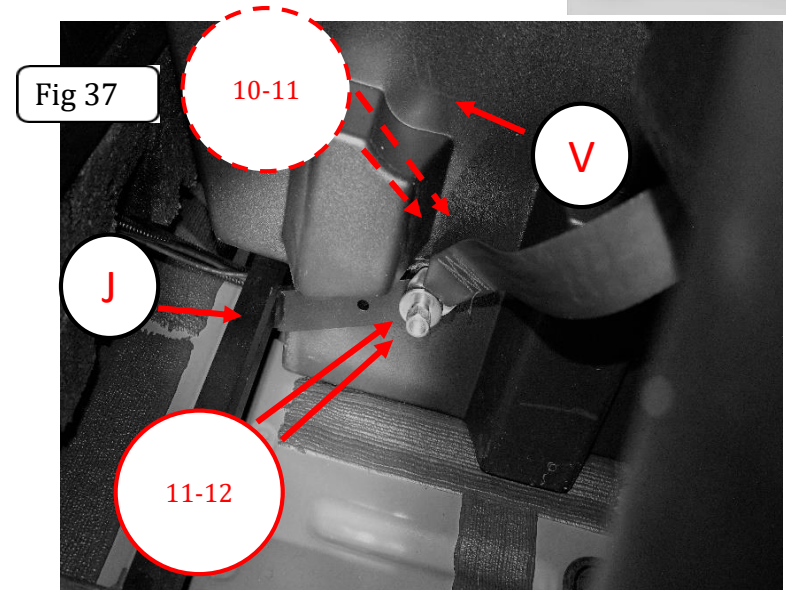

**INSTALLATION INSTRUCTIONS:**

Step 36- Maneuver [Item T] Single Cell Seat into its correct position, {Fig 38}.

Ensure [Item Z] Buckle is completely through the buckle slot in the seat.

Step 37-Mount seat [Item T] to [Item B] Crossbar. Install (3) [Item 3] Button Head Hex Drive Screws, 1/4" – 20 X 1", (3) [Item 5] Flat Washer 1/4" Install in order indicated in, {Fig 39}. Finger tighten only.

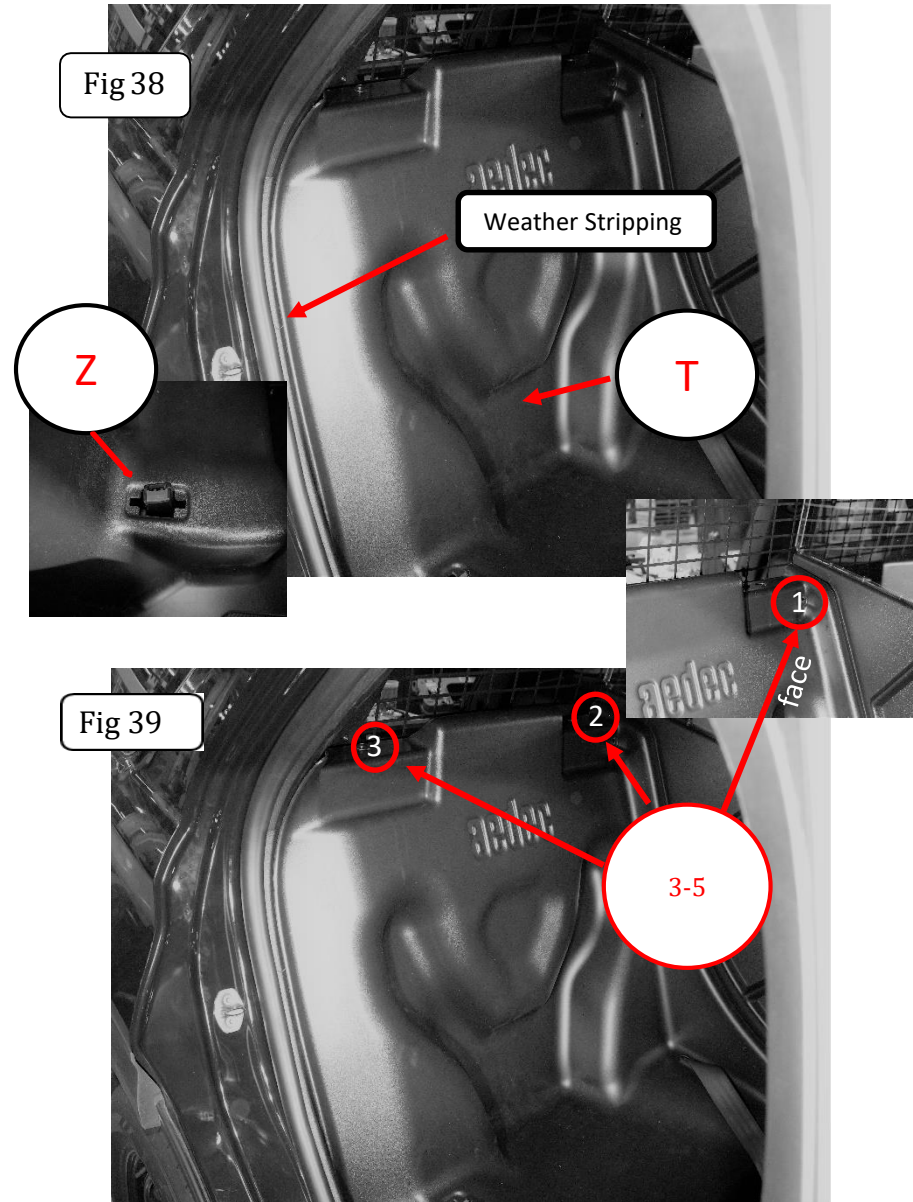

**INSTALLATION INSTRUCTIONS:**

Step 38- Insert (2) [Item 13] Button Head Hex Drive Screw M10 X 1.50MM X 35MM and (2) [Item 14] Flat Washer M10 into the front bottom of the seat, {Fig 40}. Finger tighten only.

Fig 40

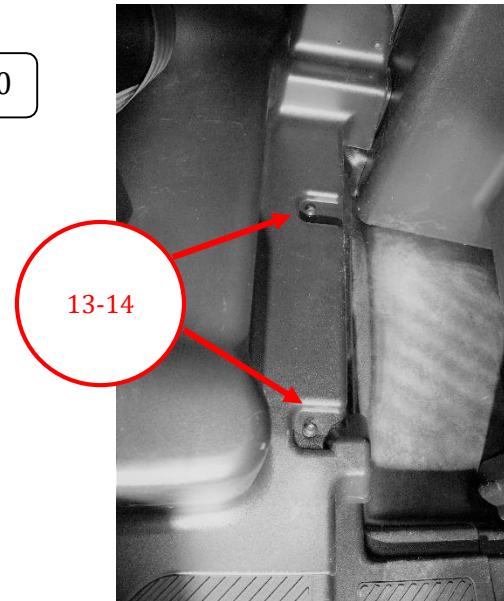

Step 39-This step will require two people. Insert (6) [Item 23] Button Head Hex Drive Screws, 1/4" – 20 X 3/4", (12) [Item 26] Flat Washer 1/4" and (6) [Item 28] Nylon-Insert Locknut, 1/4-20" through [Item T] Single Cell Seat and [Item V], Single Cell Center Lower Panel, {Fig 41}. Finger tighten only.

Fig 41

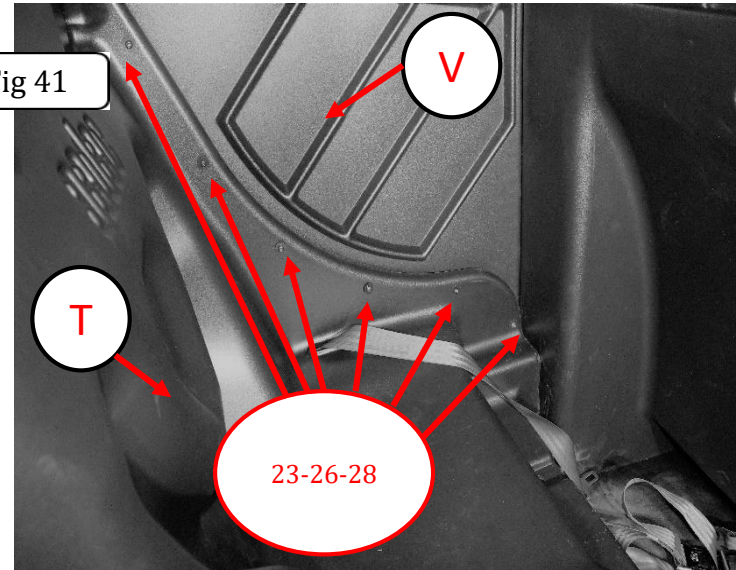



**INSTALLATION INSTRUCTIONS:**

Step 40- Ensure the belts on [Item Y] 3 Point Belt are not twisted then install (1) [Item 32] Shoulder Bolt 3/8 through the shoulder anchor plate of [Item Y] 3 Point Belt, {Fig 42}. Tighten Securely.

Now tighten Securely ALL fasteners holding the seat in place.

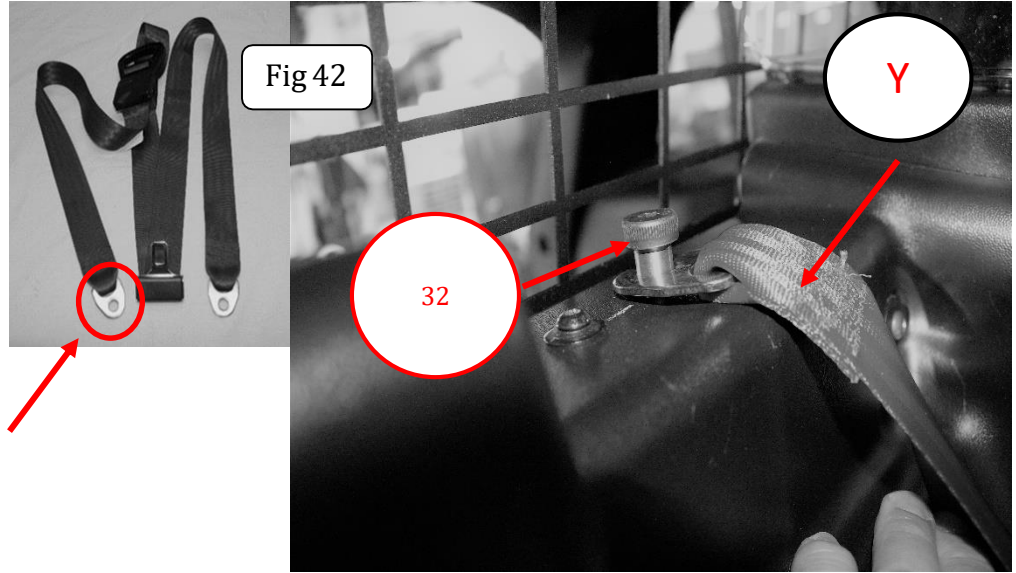

Step 41- Install [Item Z] Buckle and [Item AB] Front Belt Buckle Spacer to [Item P] Single Cell Front Lower Filler Panel using (2) [Item 25] Button Head Hex Drive Screws, 1/4" – 20 X 1 1/4", (4) [Item 26] Flat Washer 1/4" and (2) [Item 28] Nylon-Insert Locknut, 1/4-20", {Fig 43}. Tighten Securely.

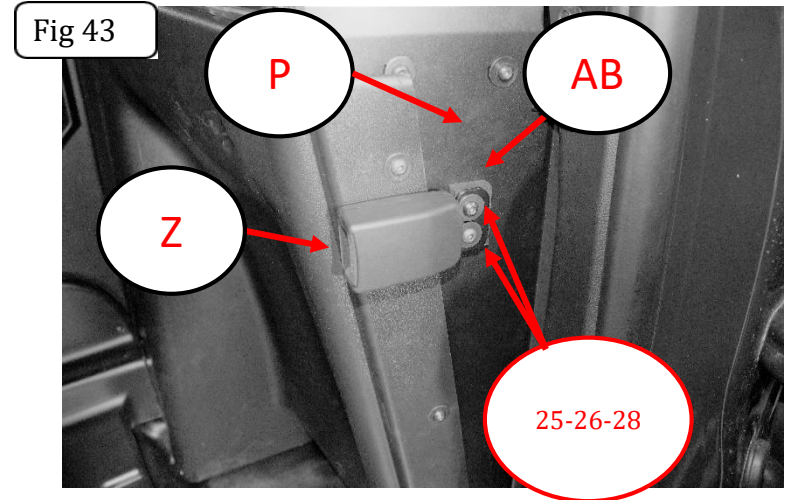

**INSTALLATION INSTRUCTIONS:**

Step 42- Install [Item AA] Buckle Cover using (4) [Item 1] Phillips Rounded Head Screw Number 6 X 1/2". To [Item T] {Fig 44}. Tighten Securely, but do not over tighten.

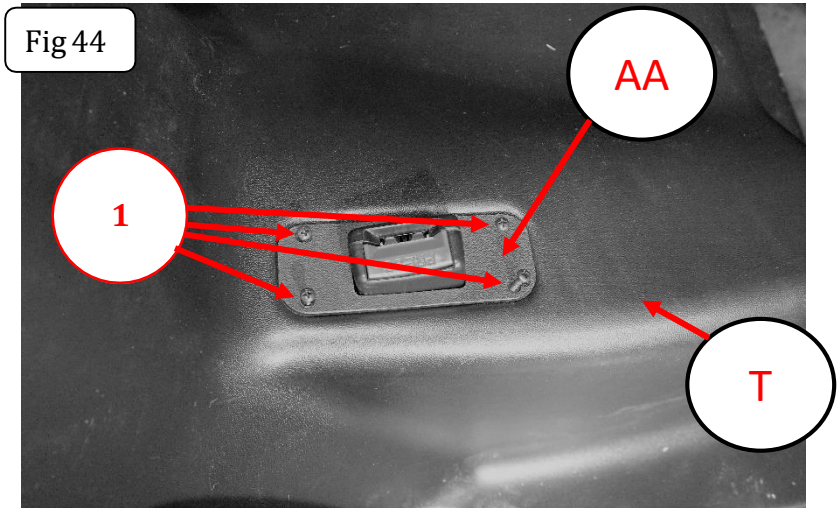

Step 43- This step will require two people. Remove the screw in the middle of the Rear Screen Window Assembly, {Fig 45}. Use this screw to mount [Item Q] Single Cell Upper Center Panel Bracket to [Item C] Rear Screen Window Assembly. Use (1) [Item 24] Button Head Hex Drive Screws, 1/4" - 20 X 1", (2) [Item 26] Flat Washer 1/4" and (1) [Item 28] Nylon-Insert Locknut, 1/4-20" {Fig 45a} to mount [Item Q] Single Cell Upper Center Panel Bracket to [Item X]. Insert [Item 24] so the head of the fastener is in the Single Cell compartment. Tighten Securely.

**Tighten Securely ALL fasteners at this time!**

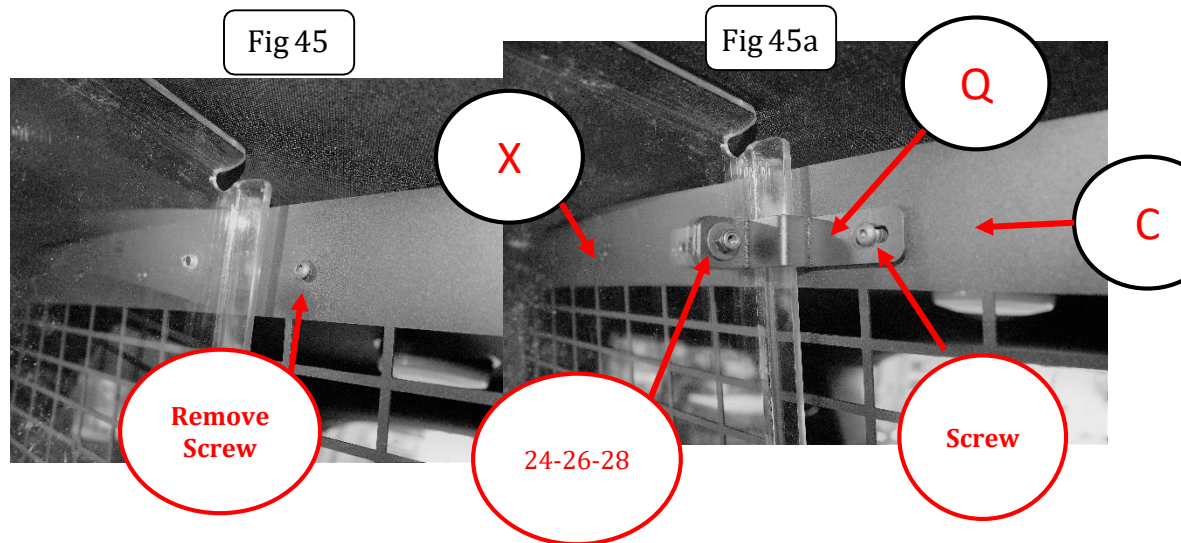

**INSTALLATION INSTRUCTIONS:**

Step 44- Install the OEM Drivers Side Rear Seat using the OEM fasteners. Place the seat in the rear driver's side compartment of the vehicle {Fig 46} and align the four holes in the seat base with four mounting holes in the chassis. Re-install the OEM fasteners and tighten securely.

Note: The rear outside fastener is best installed from the rear.

Step 45- Install [Item S] Single Cell Close Out Panel. Place in between the OEM Driver's Side Rear Seat and [Item V] Single Cell Center Lower Panel. This is a tight fit and the Single Cell Close Out Panel must be squeezed between panel and seat, {Fig 47}.

Fig 46

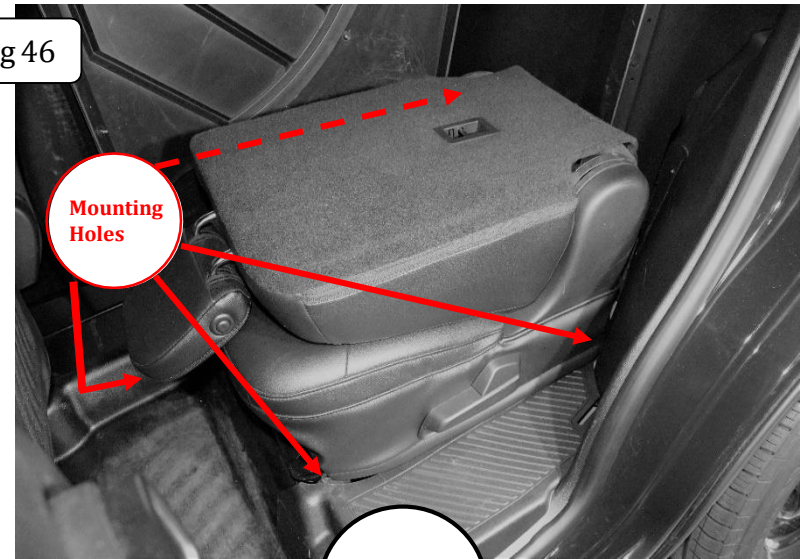
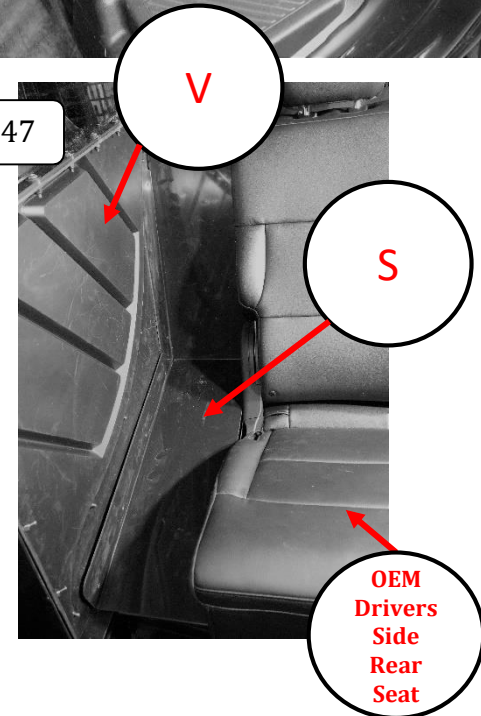

Fig 47





**INSTALLATION INSTRUCTIONS:**

Step 46- The OEM Seat will have a plastic fastener sewn into the bottom inboard material {Fig 48} (inset) insert into the bottom hole through the bottom front hole on [Item S] Single Cell Close Out Panel back into factory hole.

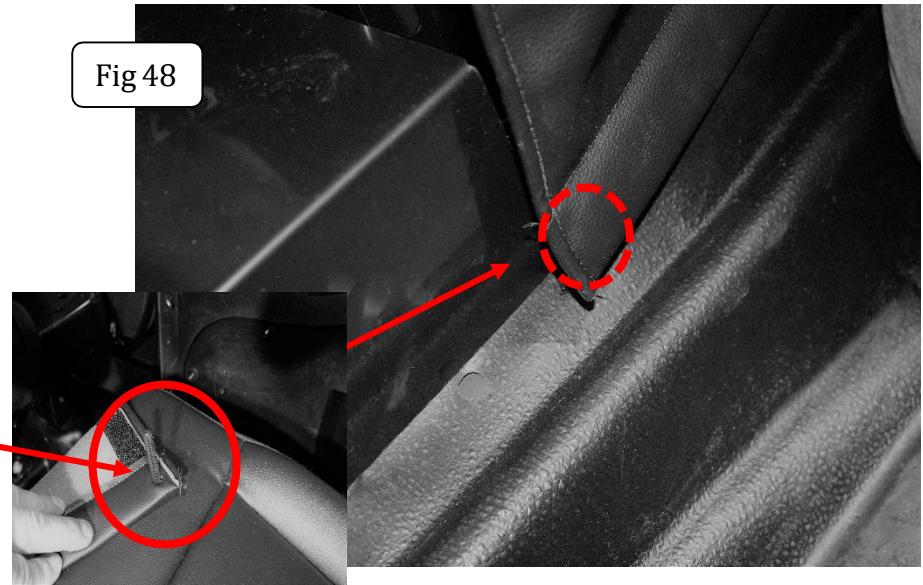
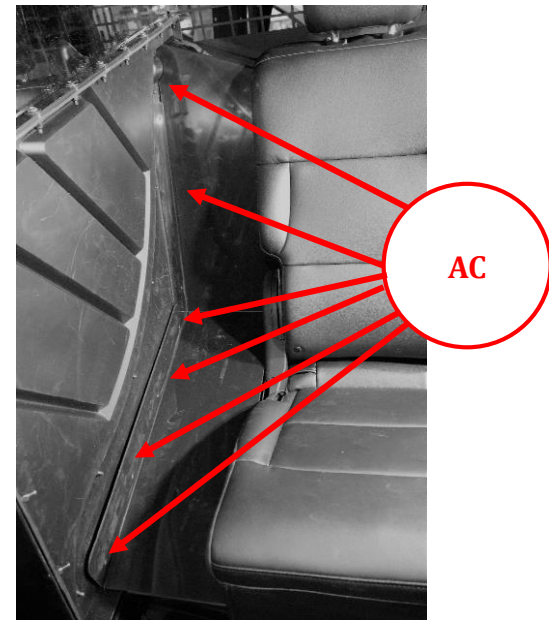

Fig 48

Step 47- Align the side holes in [Item S] Single Cell Close Out Panel with the holes in [Item V] Single Cell Center Lower Panel and fasten using (6) [Item AC] Plastic Panel Fasteners 5/16" (Christmas Tree Fasteners). Firmly push into the holes until they are fully seated, {Fig 49}.

Fig 49





**INSTALLATION INSTRUCTIONS:**

Step 48- With the large foam filler removed from Step 3, measure from the front to the center of the Ford logo, cut off the front section of the large foam filler using a handsaw, or equivalent, {Fig 50}.

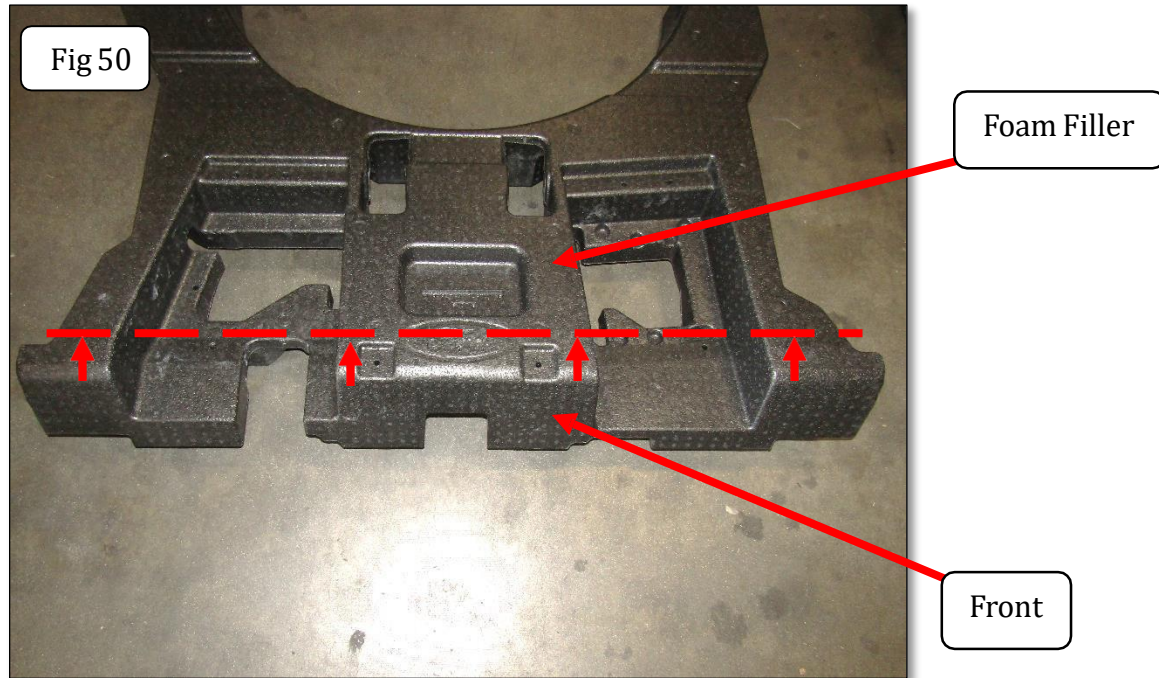

**INSTALLATION INSTRUCTIONS:**

Step 49- Reinstall the large foam filler modified in step 48 and the 2 foam fillers from each side of the tire well, {Fig 51}. Reattach the electrical panel(s).

Step 50- Replace spare tire and cover.

Step 51- Reinstall the front cover and screws, then the rear cover in the load compartment, {Fig 52}. Reinstall (2) OEM T55 Torx head screws, one per side, using a T55 Torx bit socket.

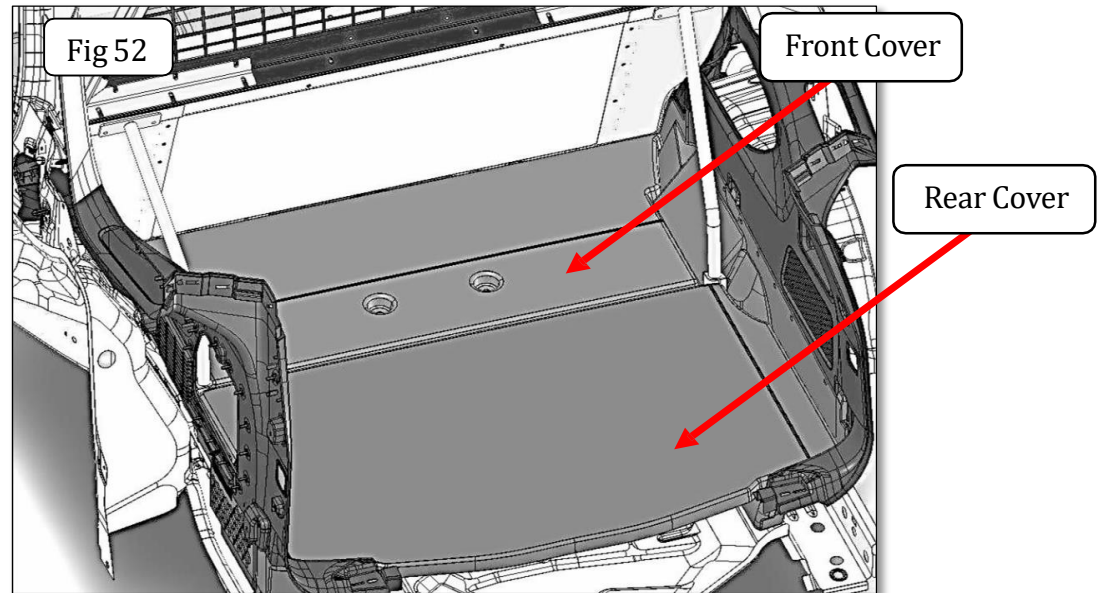
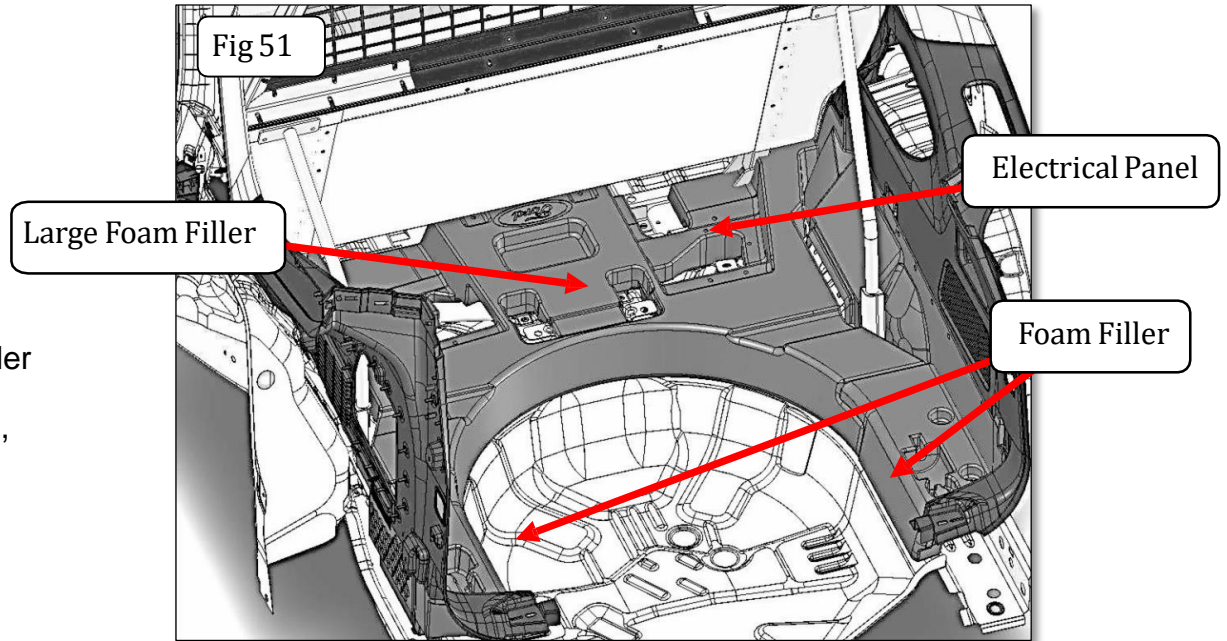

**INSTALLATION INSTRUCTIONS:**

Step 52- This step will require two people. Install [Item AD] Vent Cover to [Item X]. From the Single Cell compartment insert (4) [Item 24] Button Head Hex Drive Screws, 1/4" – 20 X 1" through the four holes around the slotted vents in [Item X] and from the driver's side rear seat compartment fasten with (4) [Item 27] Hex Nut 1/4" – 20. Securely Tighten, {Fig 53}.

Fig 53

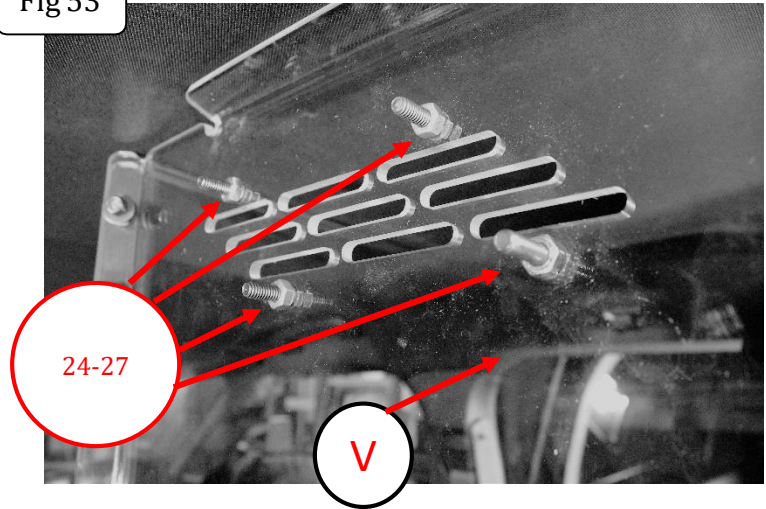

Step 53-From the driver's side rear seat compartment insert [Item AD] Vent Cover over the (4) [Item 24] Button Head Hex Drive Screws, 1/4" – 20 X 1" and fasten with (4) [Item 28] Nylon-Insert Locknut, 1/4-20", {Fig 54}. Tighten securely.

Fig 54

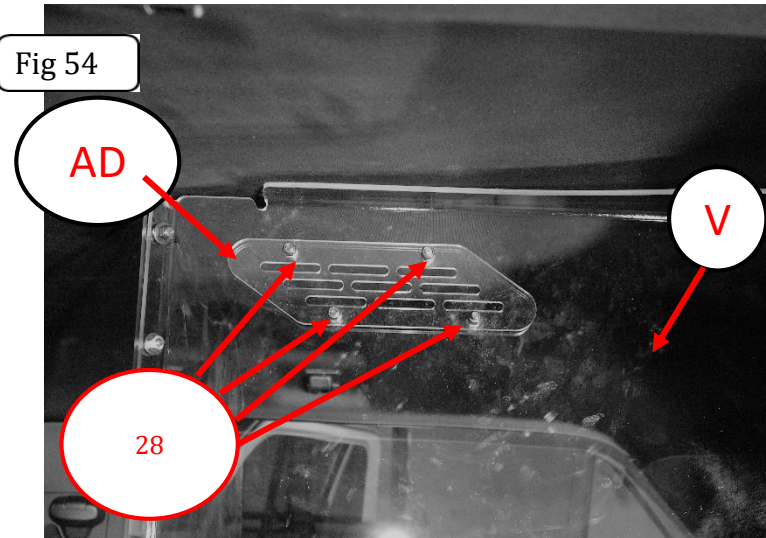



**INSTALLATION INSTRUCTIONS:**

Step 54- Insert [Item Y], 3 Point Belt into [Item Z] Buckle, {Fig 55}. Ensure all fasteners are securely tightened and cover all exposed nylon lock nuts with the supplied plastic covers.

The Single Cell is now complete.

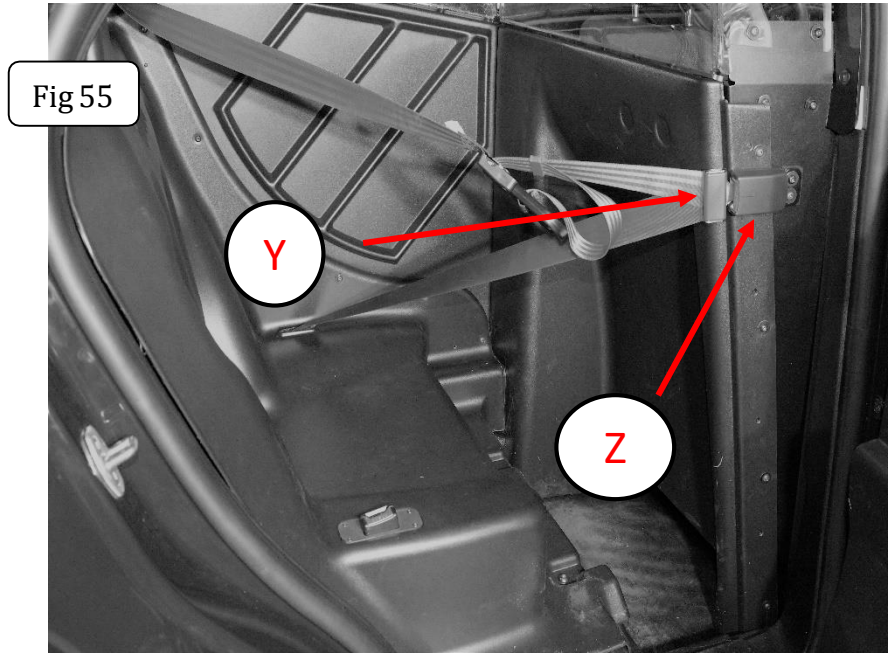



## INSTALLATION INSTRUCTIONS

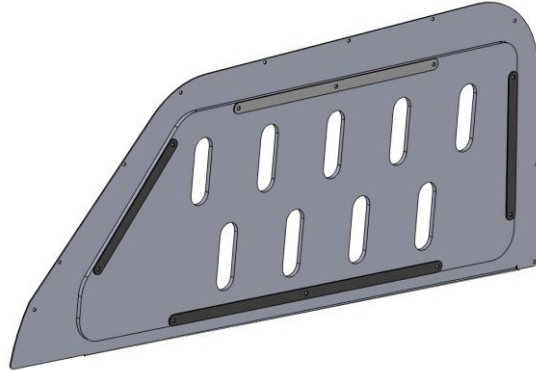

PART NO.

- 571724

PRODUCT DESCRIPTION:

- POLYCARBONATE WINDOW GUARDS

APPLICATION:

- FORD INTERCEPTOR UTILITY

### PRODUCT SAFETY & LEGAL DISCLAIMER

- **IMPORTANT READ ALL INSTRUCTIONS CAREFULLY BEFORE INSTALLING. FAILURE TO DO SO MAY CAUSE PERSONAL INJURY OR DAMAGE TO PRODUCT AND/OR PROPERTY.**
- **Review the product package and contents prior to beginning the installation.** Take care when opening the packaging and removing items. If a return is needed you will want to return the product in its original packaging if possible.
- This instruction guide is provided as a GENERAL installation guide, some vehicles vary dimensionally and may require additional steps.
- Test fit the product on the vehicle prior to any third party modifications and or finishing. The manufacturer and/or distributors do not accept responsibility for third party charges, labor and or third part replacement modifications. Some modifications may void the factory warranty.
- Exercise due-diligence when installing this product. The manufacturer and distributors of this product do not accept any responsibility for vehicle damage or personal injury resulting from the installation of this product. Careless installation and operation can result in serious injury or equipment damage.
- This product is for general off-road use. All liability for installation and use rests with the owner/operator.
- **INSTALLER:** Once installation is complete, please return this guide along with other documentation included in this product back to the consumer for future reference. The manufacturer/distributors of this product do not guarantee this particular version will be available at a later date.

© 2016 Go Rhino Products. All rights reserved



## INSTALLATION INSTRUCTIONS

### INJURY HAZARD

Please complete a shop and tool inspection prior to beginning the installation.

- Always make sure you have a clean, dry and well lit work area.
- Always remove jewelry, loose fitting clothing and wear protective gloves and eye protection.
- Always use extreme caution when jacking or raising a vehicle for work. Set the emergency brake and use tire/wheel blocks and jack stands. Refer to the vehicle manufacturer hand book. Utilize the vehicle manufacturers designated lifting points.
- Always use appropriate and adequate care in lifting parts during disassembly and installation. Seek help in lifting heavy or large items into place. Utilize jacks and or lifting devices when available.
- Always insure products are secure during disassembly and installation.
- Always wear eye protection and take steps to protect any exposed skin during the installations. Drilling, cutting and grinding plastic and metal may create flying particles that can cause injury.
- Always use extreme caution when drilling, cutting and or grinding on a vehicle. Thoroughly inspect the area to be drilled, on both sides of material, prior to modification and relocate any objects that may become damaged.
- Always assemble and tighten all fasteners per the installation instructions.
- Always route electrical cables carefully. Avoid moving parts, parts that may become hot and rough or sharp edges.
- Always insulate and protect all exposed wiring and electrical connections.

### MAINTENANCE AND CARE

- Always perform regular inspections and maintenance on mounts and related fasteners.
- Periodically check and tighten all fasteners.
- Stripped, fractured, or bent fasteners must be replaced.
- After washing the vehicle make sure to fully dry all surfaces.
- In areas with cold temperatures make sure to wash the product often to remove harmful materials used on road ways.
- Never use abrasive cleaners or polish compounds. Clean with a gentle soap and water. If you use wax use a non-abrasive automotive wax such as pure carnauba wax.

### WARNING

Some products have been designed to work together with factory rear sensor systems, factory forward facing sensor systems and factory air bags.

- Installation of some of these products may alter the factory sensor system performance.
- Factory sensors may read shackles or hooks protruding from the fairlead and or tow hooks.
- All sensor testing is completed by Go Rhino Products and or third party testing labs on modified vehicles.
- Sensor sensitivity, factory sensor housing, orientation, and operating conditions are all variables that will influence functionality of the sensors.
- Installation of some product may effect the factory air bag systems.
- Some products allow the use of third party products such as winches, shackles, hooks, etc. Follow the respective manufacturers operating instructions for use with our products.
- Make sure to fully understand the product, it's intended use and operation prior to use.
- Above all... be safe!

## INSTALLATION INSTRUCTIONS

PARTS INCLUDED IN THIS LIST:

ITEM	QTY.	DESCRIPTION	ITEM	QTY.	DESCRIPTION
A	22	#8 X 3/4" Self Drilling Screw	C	1	Passenger Side Window Guard
B	1	Driver Side Window Guard			

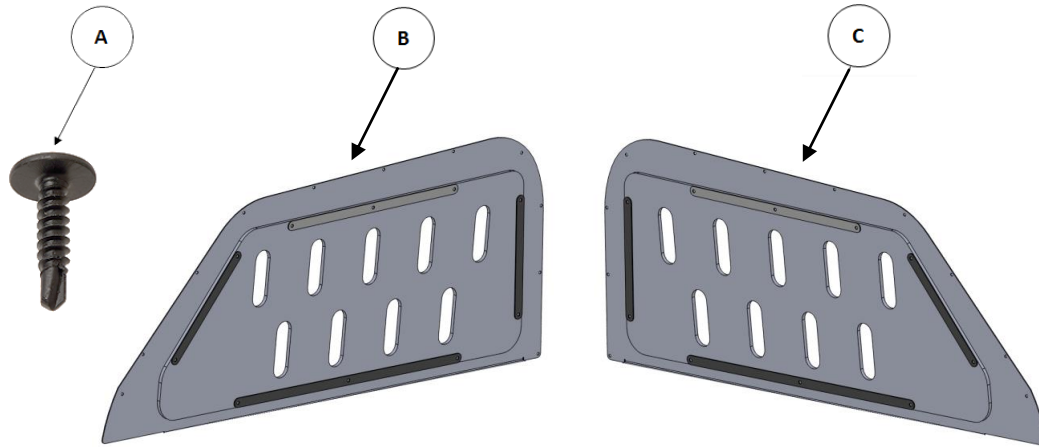

Go Rhino recommends you, the installer, read this installation instruction manual from front to back before installing the product. You may also [click here](http://www.gorhino.com/Installation-Videos) to view an installation video or visit <http://www.gorhino.com/Installation-Videos>.

TOOLS NEEDED FOR INSTALLATION:

- #2 Phillips Driver Bit
- Drill Motor

ESTIMATED TIME FOR INSTALLATION:

1 Hour

If you need installation service for your new product, call the authorized distributor from whom you purchased the product or an authorized installation service company which can be found by calling toll free 1-888-427-4466

## INSTALLATION INSTRUCTIONS

**Step 1** Beginning with the driver side, open the rear door and roll down the rear window.

**Step 2** Position the bottom of the driver side window guard frame so it is resting on top of the door trim panel and the right side outer edge of the frame is flush with the door window frame molding.

**Step 3** With the window guard in place, install the (11) #8 X 3/4" self-drilling screws starting at the bottom on each side first, and then work up each side to install the remaining screws. Repeat steps to install the passenger side window guard.

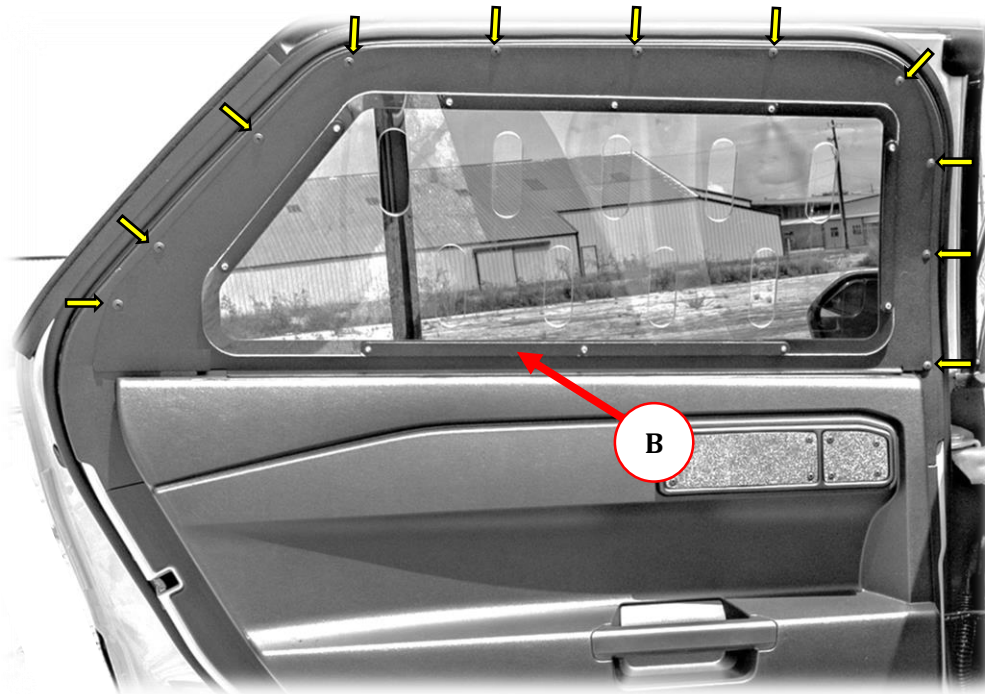





## INSTALLATION INSTRUCTIONS

### LIMITED WARRANTY

Go Rhino warrants to Buyer that for a period of five (5) years from the date of shipment of the product(s) ("Warranty Period") for black finishes and chrome finishes, that such products will materially conform to the specifications set forth in Go Rhino's specifications in effect as of the date of shipment(s) and will be free from material defects in material workmanship.

Go Rhino warrants to Buyer that for the life of the product(s) from the date of shipment of the product(s) ("Warranty Period") for polished stainless steel finished products purchased after April 2004, that such products will materially conform to the specifications set forth in Go Rhino's specifications in effect as of the date of shipments and will be free from material defects in material workmanship.

Warranty claims must be accompanied with the original invoice and photos of the product. It is the customer's responsibility to clean regularly and protect finish with regular applications of a nonabrasive polish that is compatible with the product's finish.

This warranty covers the cost of the product only and does not include the cost of removal, installation, third party modifications or shipping of the product. In no event shall Go Rhino be liable to buyer or any third party for any damage or harm caused by the product or use thereof, regardless of whether such damages were foreseeable and whether or not Go Rhino has been advised of the possibility of such damages, not withstanding the failure of any agreed or other remedy of its essential purpose. This warranty is void if the product shows signs of alteration, misuse, mishandling, improper care, neglect, improper application and/or damage due to improper installation.

With respect to any such product(s) during the limited warranty period, Go Rhino shall, in its sole discretion, either: (i) provide a one-time repair or replacement of such products (or the defective part) or (ii) credit or refund the price of such products at the pro rata contract rate provided that, if Go Rhino so requests, Buyer shall, at Go Rhino's expense, return such product(s) to Go Rhino. The remedies shall be the Buyer's sole and exclusive remedy and Go Rhino's entire liability for any breach of the limited warrant(ies).

Go Rhino disclaims all other warranties except to the extent that any such warranty cannot be validly disclaimed under applicable law.

#### **Finish Limited Warranty:**

Limited lifetime on stainless steel products (after April 2004)

5 year warranty on black powder coat products

5 year warranty on chrome products

This warranty does not cover exposed welds

Finish warranty covers peeling, flaking, or cracking. Washing all finishes regularly with car wash soap and rinsing well with water is the best method for maintaining the finish on your products. You must also protect the finish with nonabrasive automotive wax on a regular basis. The use of any compound which contains abrasives becomes a self-defeating exercise as the compound scratches the finish and opens it to corrosion. The use of harsh chemicals used to remove bugs and tar may also cause the finish to fail and should be avoided.

If you are unsatisfied with your purchase please contact the establishment you purchased the product from.

If you need to place a warranty claim or need assistance, the Go Rhino customer service team will answer any questions you may have. Please contact the Go Rhino customer service team at 1-888-427-4466 during normal business hours Monday thru Friday 7 am to 5 pm PST. You may also email [warranty@gorhino.com](mailto:warranty@gorhino.com). In order to better serve you please provide a copy of the original invoice / receipt, a photo of the issue you are experiencing and a photo of the vehicle the product is installed on.

All warranty returns must have an approved RGA number. The RGA number must be clearly marked on the exterior of the return package. All approved warranty returns must be shipped to Go Rhino Products, 1002 Carriers Drive, Laredo, Texas 78045.

### PRODUCT REGISTRATION

Please remember to register your new purchase. You may register your product at [www.gorhino.com](http://www.gorhino.com). Registering your product may help speed any future warranty or customer service inquiries.

## Thank you again for purchasing from Go Rhino Products

Please take a few minutes to view additional products for your vehicle and more at [GORRHINO.com](http://GORRHINO.com). These installation instructions are available on the Go Rhino web site along with installation videos for many of our products.

[www.gorhino.com](http://www.gorhino.com)   [www.bigcountryauto.com](http://www.bigcountryauto.com)   [www.gorhinopd.com](http://www.gorhinopd.com)