



**CHEVROLET TAHOE PPV SINGLE CELL
3 POINT BELT SYSTEM INSTALLATION
INSTRUCTIONS 5703523FW-FWA**

Important Notice: Read all instructions before starting the installation of the seat. Before drilling or installing any screw or fastener into the body of the vehicle it is imperative to ensure the drill bit or fastener will not penetrate any fuel line, fuel tank, brake lines or wires.



INSTALLATION INSTRUCTIONS

PRODUCT SAFETY & LEGAL DISCLAIMER

- Read and understand all safety precautions and instructions before installing this product.
- **Review the product package and contents prior to beginning the installation.** We make every effort to provide a perfect product but we are human and a mistake may happen from time to time. Take care when opening the packaging and removing items. If a return is needed you will want to return the product in its original packaging if possible.
- This product is intended to be installed by a certified technician, therefore a certain level of competence and knowledge are assumed when reading these instructions.
- This instruction guide is provided as a GENERAL installation guide, some vehicles vary dimensionally and may require additional steps.
- **Make certain to completely unpack the contents of the shipping container. Unwrap all parts and inspect parts prior to installing.**
- Test fit the product on the vehicle prior to any third party modifications and or finishing. The manufacturer and distributors will not accept responsibility for third party charges, labor and or third part replacement modifications. Some modifications may void the factory warranty.
- Exercise due-diligence when installing this product. The manufacturer and distributors of this product will not accept any responsibility for vehicle damage or personal injury resulting from the installation of this product. Installation of this product is acceptance of this statement and releases the manufacturer/Distributors of this product from any direct or indirect liabilities.
- Careless installation and operation can result in serious injury or equipment damage.
- Once installation is complete, please return this guide along with other documentation included in this product back to the consumer for future reference. The manufacturer/distributors of this product do not guarantee this particular version will be available at a later date.
- All liability for installation and use rests with the owner/operator.



INSTALLATION INSTRUCTIONS

INJURY HAZARD

Please complete a shop and tool inspection prior to beginning the installation.

- Always make sure you have a clean, dry and well-lit work area.
- Always remove jewelry, loose fitting clothing and wear protective gloves and eye protection.
- Always use extreme caution when jacking or raising a vehicle for work. Set the emergency brake and use tire/wheel blocks and jack stands. Refer to the vehicle manufacturer handbook. Utilize the vehicle manufacturers designated lifting points.
- Always use appropriate and adequate care in lifting parts during disassembly and installation. Seek help in lifting heavy or large items into place. Utilize jacks and or lifting devices when available.
- Always ensure products are secure during disassembly and installation.
- Always wear eye protection and take steps to protect any exposed skin during the installations. Drilling, cutting and grinding plastic and metal may create flying particles that can cause injury.
- Always use extreme caution when drilling, cutting and or grinding on a vehicle. Thoroughly inspect the area to be drilled, cut or ground both on the bottom and top of the surface. Ensure no wires, exhaust or any type of liquid lines will or can be damaged while drilling, cutting or grinding. If objects that are not intended to be drilled or cut are in the way of the hole or cut, they will need to be relocated.
- Always assemble and tighten all fasteners per the installation instructions.
- Always route electrical cables carefully. Avoid moving parts, parts that may become hot and rough or sharp edges.
- Always insulate and protect all exposed wiring and electrical connections.

MAINTENANCE AND CARE: Never use abrasive cleaners or polish compounds. Clean with a gentle soap/disinfectant and water.

TOOLS NEEDED FOR INSTALLATION:

- ✓ Inch & Metric Wrench Set
- ✓ Inch & Metric Socket Set
- ✓ T50 Torx Bit Socket
- ✓ 5/32" & 6MM Hex Bit Socket
- ✓ Hole Aligning Punch
- ✓ Ratchet & Ratchet Extension
- ✓ Slot Head Screw Driver (small)
- ✓ Tape Measure
- ✓ Cutoff Tool
- ✓ Razor Knife

ESTIMATED TIME FOR INSTALLATION: 2.5 – 3.0 Hours

COMPONENT BOX 5UT2100P-PA & 5UT2100F

ITEM	QTY	DESCRIPTION
A	1	Rear Window Assembly
B	1	Upper Filler Panel (Left Side)
C	1	Upper Filler Panel (Right Side)
D	1	Center Closeout Panel (Left Side)
E	1	Center Closeout Panel (Right Side)
F	1	Outer Closeout Panel (Left Side)
G	1	Outer Closeout Panel (Right Side)
H	1	Outer Buckle Bracket (Left Side)
I	1	Outer Buckle Bracket (Right Side)
J	1	Center Belt Bracket
K	1	Rear Crossbar
L	1	Floor Strut (Left Side)
M	1	Floor Strut (Right Side)

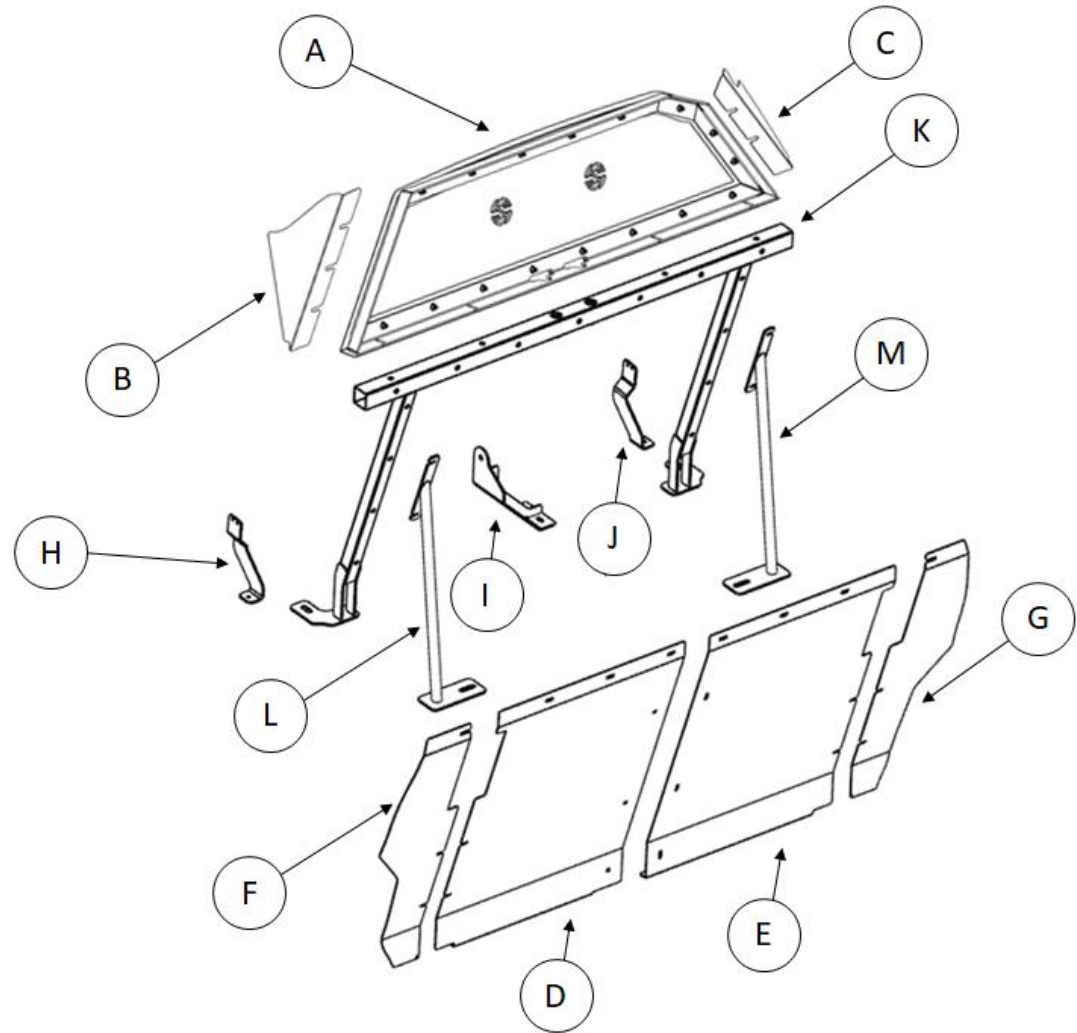

COMPONENT BOX 5UT2100F

ITEM	QTY	Description	ITEM	QTY	Description
1	8	Phillips Rounded Head Screw Number 6 X 1/2"	7	14	SEMS Button Head Hex Drive Screw 1/4"-20 x 3/4" X 1"
2	4	Countersink Screw Number 8 X 1/2"	8	8	Hex Head Screw 1/4"-20 X 1 1/4"
3	11	Button Head Hex Drive Screw 1/4"-20 X 1"	9	1	Hex Head Screw 1/2"-13 X 1-1/2"
4	8	Split Lock Washer 1/4"	10	2	Flat Washer 1/2"
5	19	Flat Washer 1/4"	11	1	Nylon-Insert Locknut 1/2"-13
6	8	Nylon-Insert Locknut 1/4"-20	12	2	Hex Nut 1/2"-13

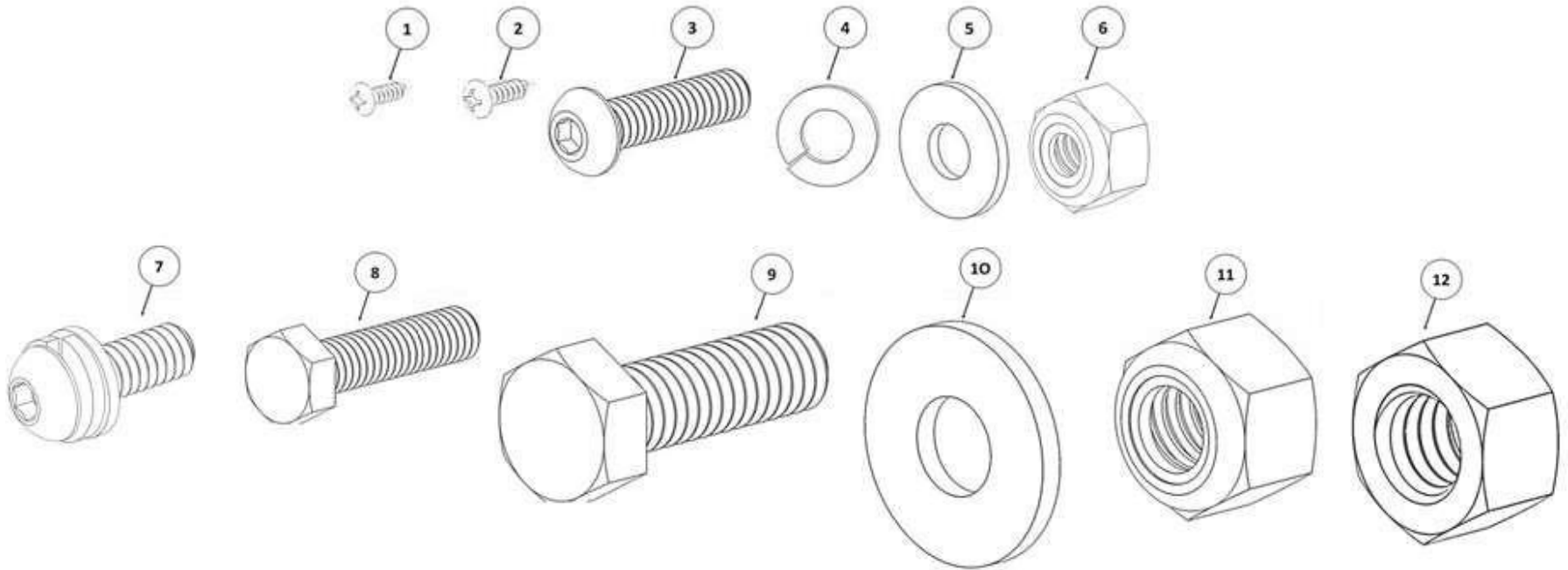

COMPONENT BOX 5UT2100F

ITEM	QTY	Description	ITEM	QTY	Description
13	2	Hex Head Screw M10-1.5 X 35MM	16	4	Flat Washer 3/8"
14	6	Split Lock Washer M10	17	2	Shoulder Screw 3/8"-16
15	10	Flat Washer M10	18	4	Round Base Magnet

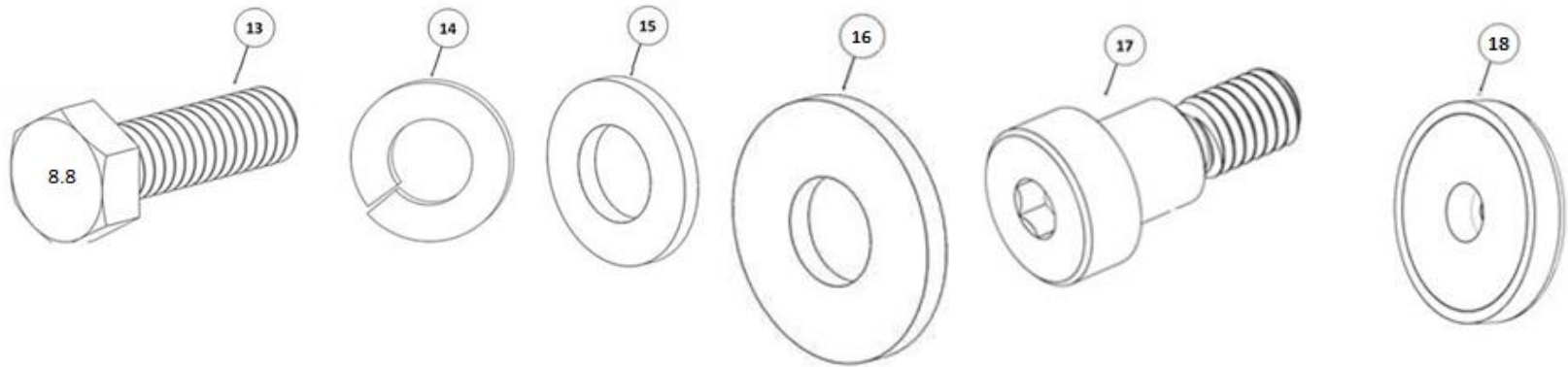

COMPONENT BOX 570351

ITEM	QTY	Description	ITEM	QTY	Description
N	1	Foot Bracket	Q	1	Upper Center Panel Bracket
O	1	Upper B Pillar Bracket	R	1	Seat Adapter Bracket (Inner)
P	1	Lower B Pillar Bracket	S	1	Seat Adapter Bracket (Outer)

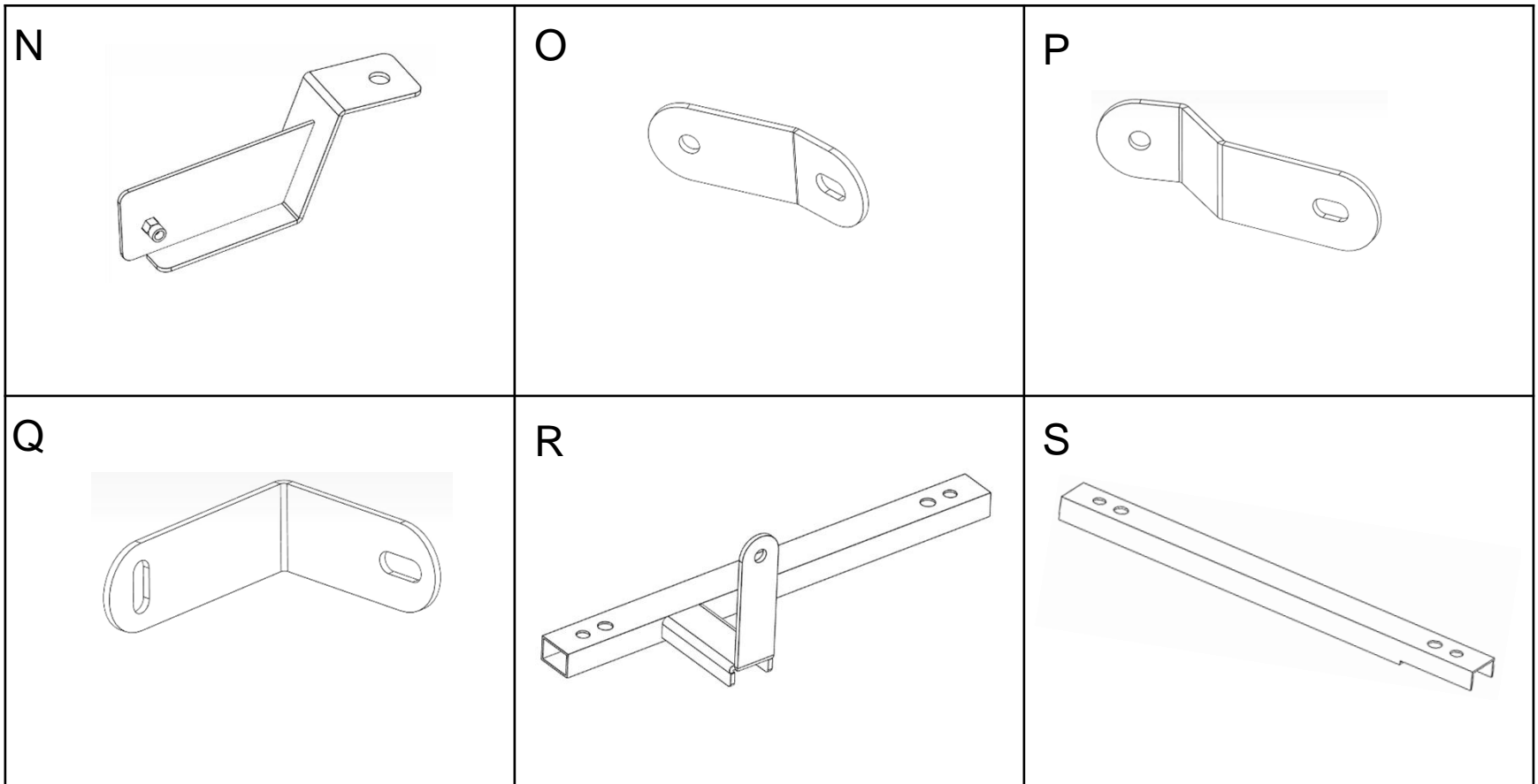

COMPONENT BOX 570351

ITEM	QTY	Description	ITEM	QTY	Description
19	44	Plastic Nut Caps	25	44	Nylon-Insert Locknut 1/4"-20
20	13	Button Head Hex Drive Screw 1/4"-20 X 3/4"	26	4	Button Head Hex Drive Screw M10-1.5 x 60MM
21	32	Button Head Hex Drive Screw 1/4"-20 X 1"	27	1	Hex Bolt 1/2"-13 x 1 1/2"
22	2	Button Head Hex Drive Screw 1/4"-20 X 1-1/4"	28	2	Flat Washer 1/2"
23	81	Flat Washer 1/4"	29	1	Nylon-Insert Locknut 1/2"-13
24	4	Hex Nut 1/4"-20	30	1	Push-on Edge Trim / 32" Length

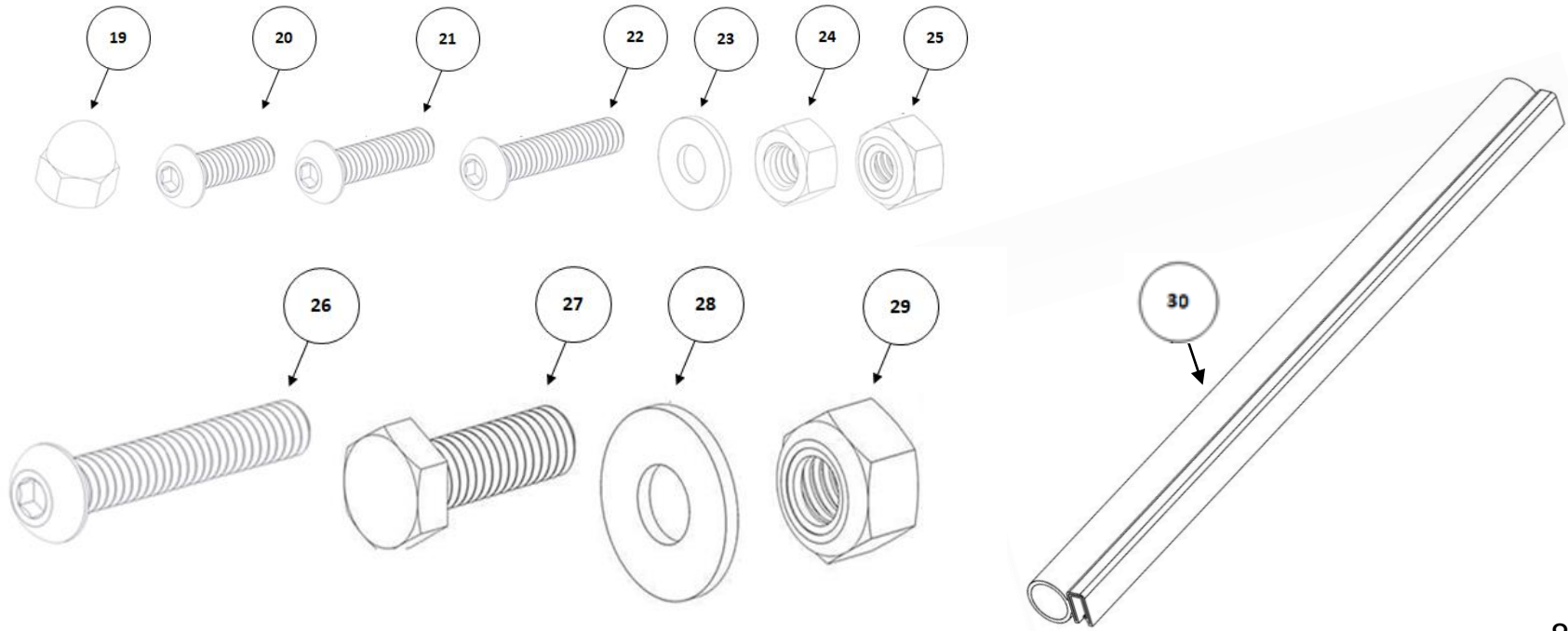

COMPONENT BOX ST2133

ITEM	QTY	Description	ITEM	QTY	Description
T	1	Single Cell Seat	W	1	Front Upper Panel
U	1	Front Lower Panel	X	1	Center Upper Panel
V	1	Center Lower Panel	Y	1	Vent Cover

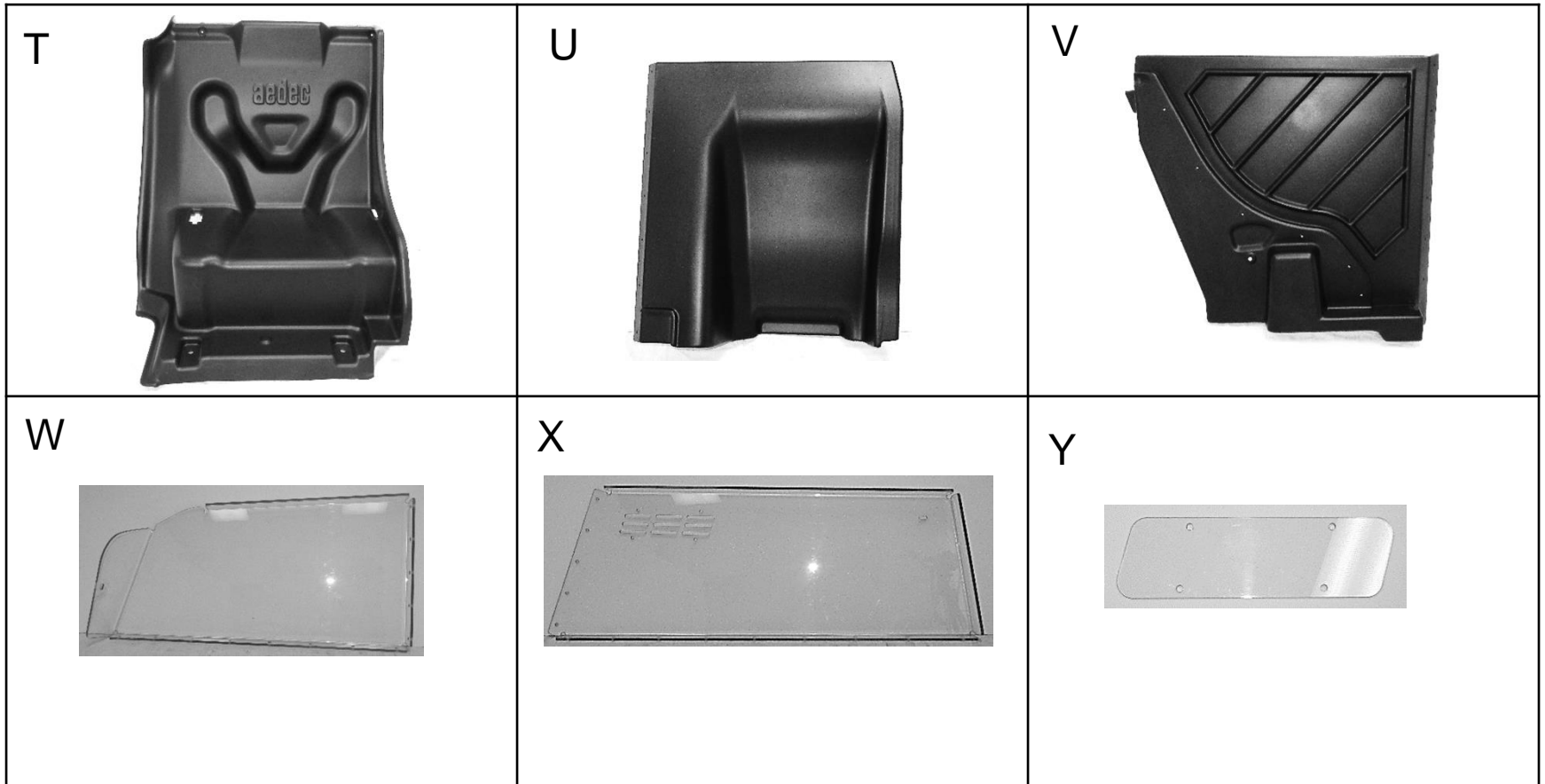

COMPONENT BOX ST2133

ITEM	QTY	Description	ITEM	QTY	Description
Z	2	Buckle	AC	1	Waist Buckle
AA	2	Buckle Trim Plate	AD	1	3-Point Belt
AB	1	Buckle Spacer			

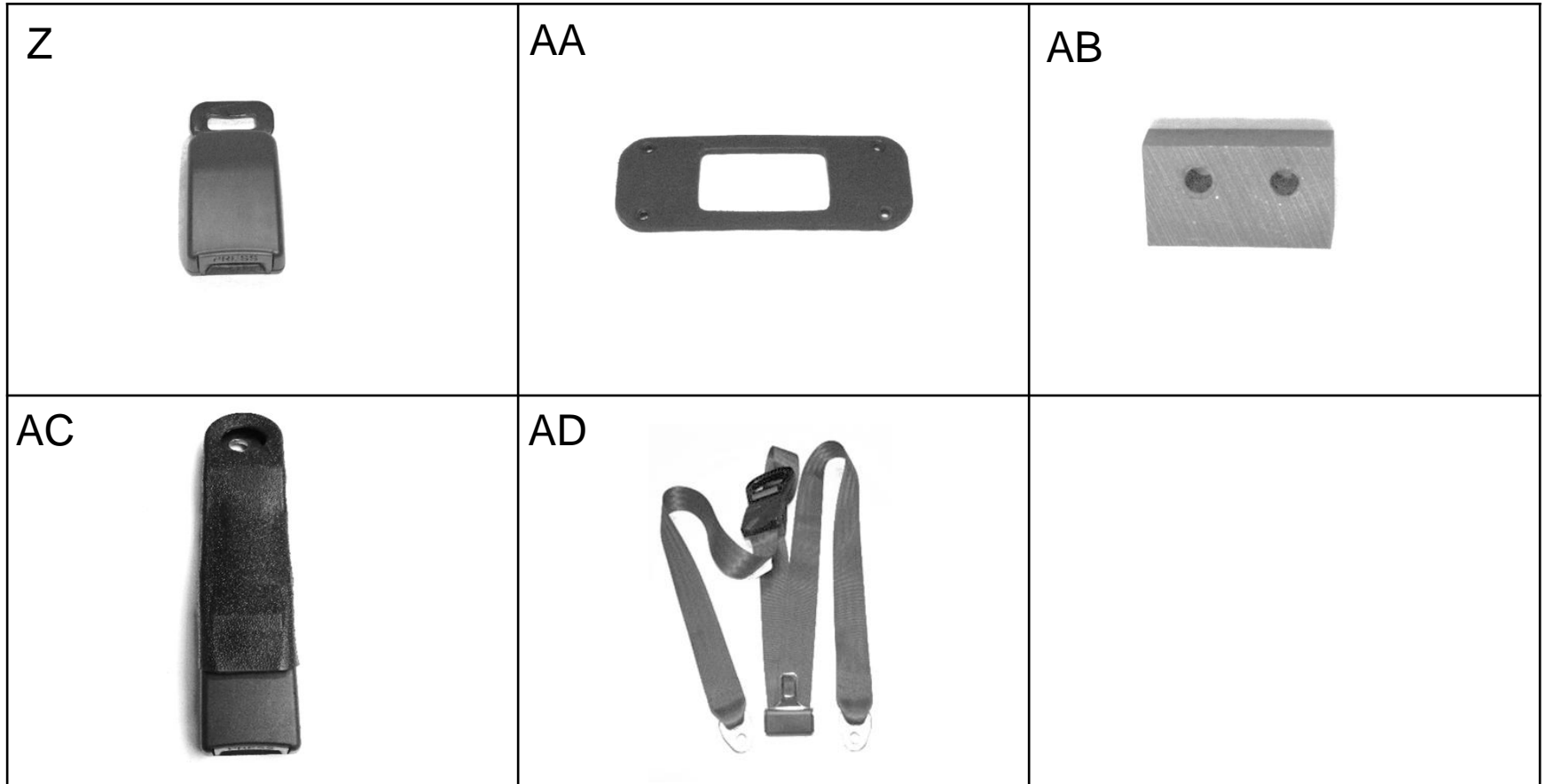

Step-1 Adjust the front seats and backs to the full forward position.

Step-2 Remove the passenger side middle B-pillar trim panel from the center of the B-pillar by gently pulling out, (Fig1).

Step-3 Using a small slotted head screw driver to open the cover on the top of the passenger side upper B-pillar trim panel to expose the attachment screw, (Fig 2). Remove the screw using a 7mm socket.

Step-4 Pull out gently the upper B-pillar trim to expose the (2) attachment screws of the entry assist handle.

Step-5 Remove the screws securing the entry assist handle to the B-pillar using a 10mm socket, (Fig 3).

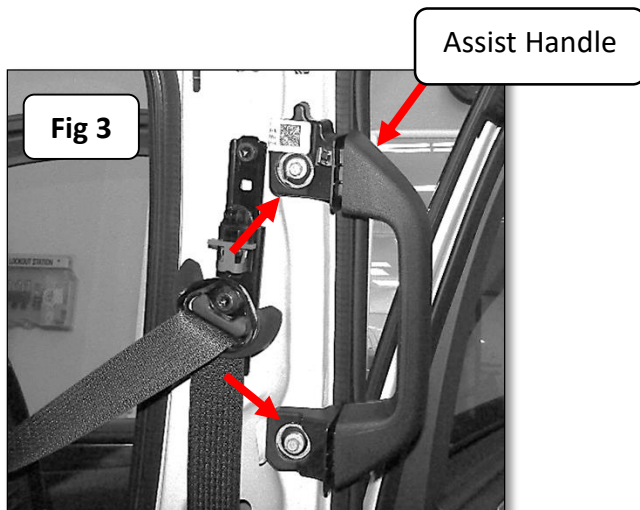
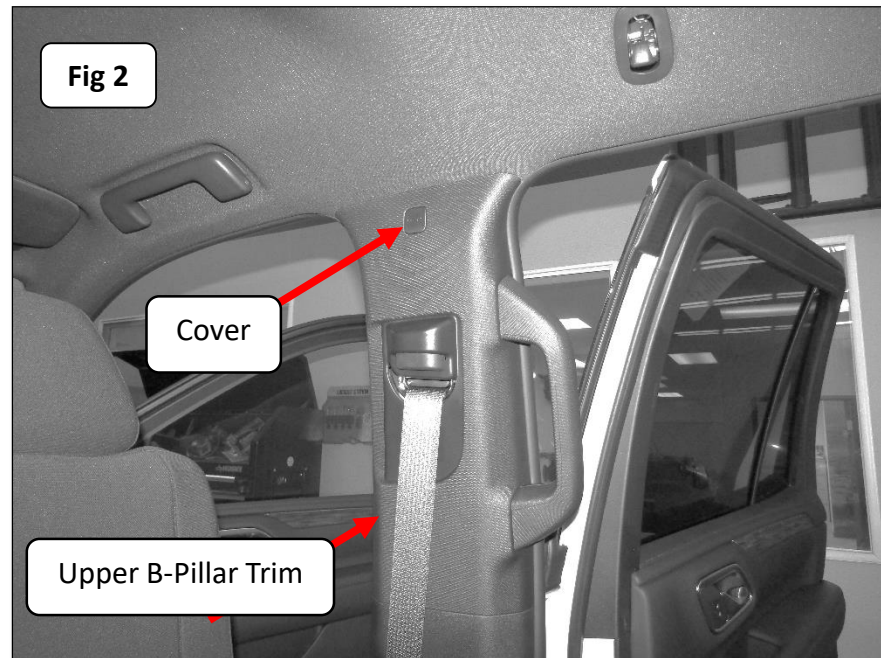

Step-6 Secure the upper and lower B-Pillar Bracket using the entry assist handle factory screws. Measure and position the upper B-Pillar Bracket and the lower B-Pillar Bracket so the slot hole in the opposite end of the upper bracket is 27 ¼", and the lower bracket is 18 3/8" from the bottom edge of the Center B-pillar trim panel then tighten the screws, (Fig 4). Reinstall the B-pillar trim panels, (Fig 5).

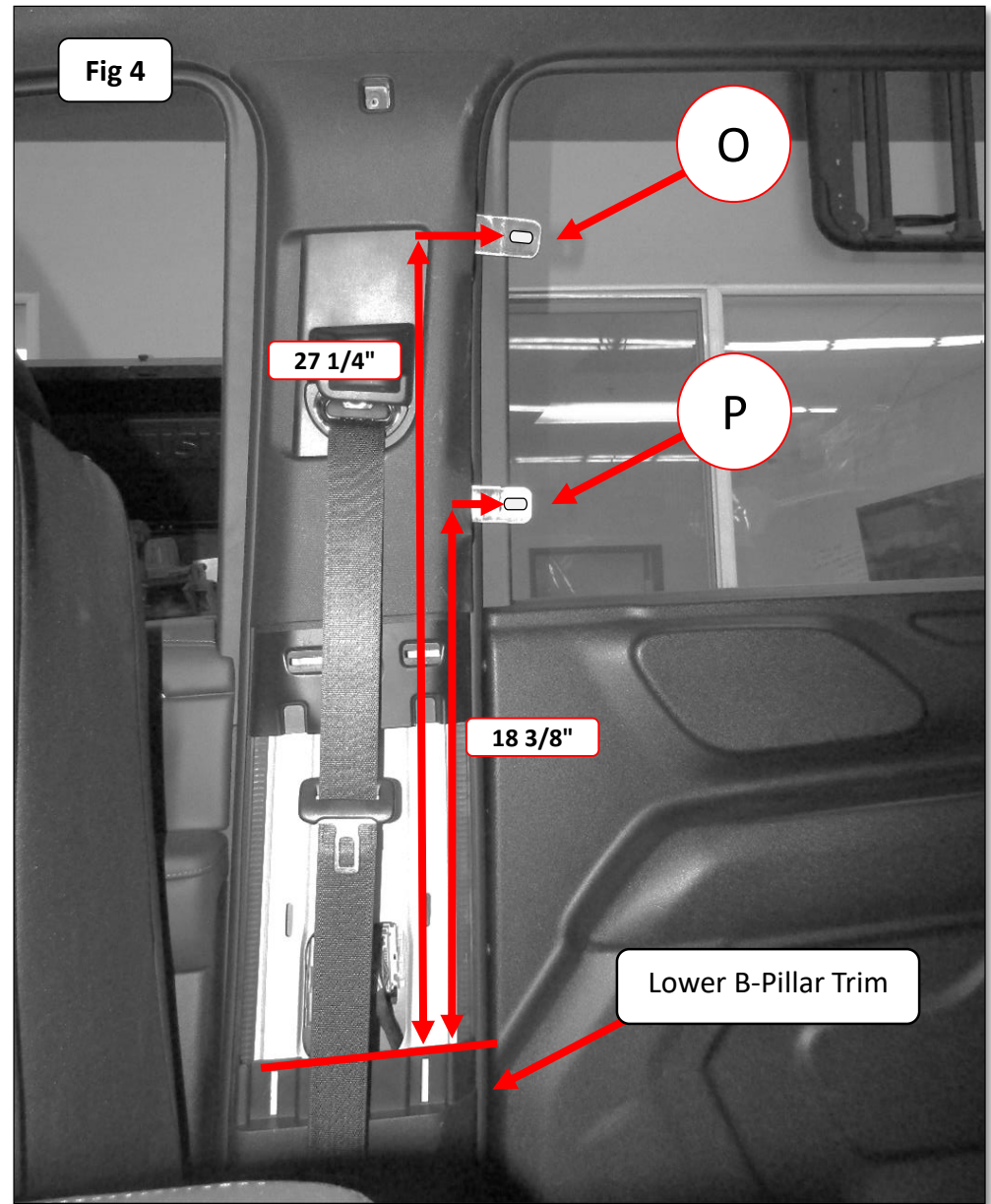
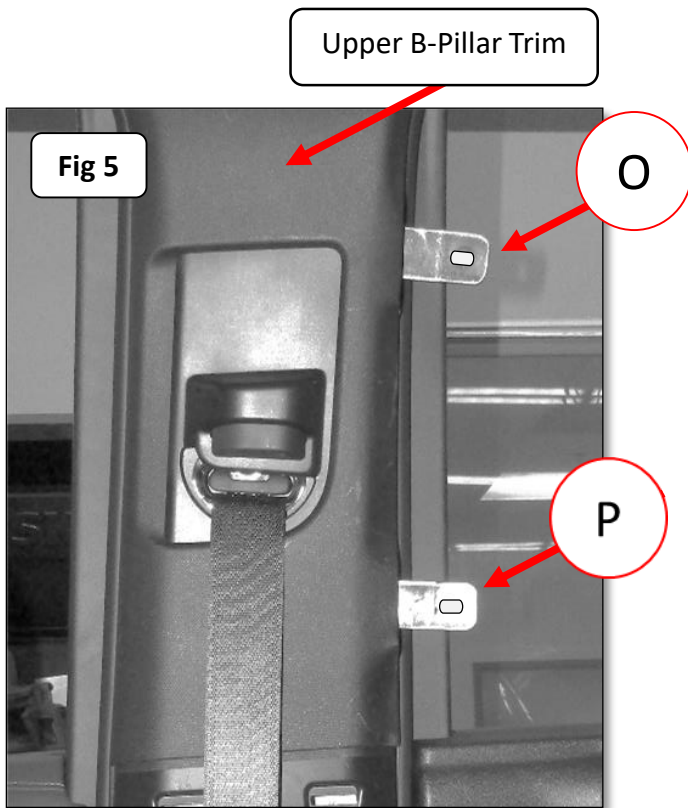

Step-7 Using a T50 Torx driver, remove the Torx head screw securing the rear of the passenger side outer seat track and loosen the rear screw securing the inner seat track, (Fig 6).

Step-8 Position the Foot Bracket under the outer seat track, align the attachment hole with the seat track and reinstall the seat track screw, (Fig 7). Leave the screws loose for final adjustment.

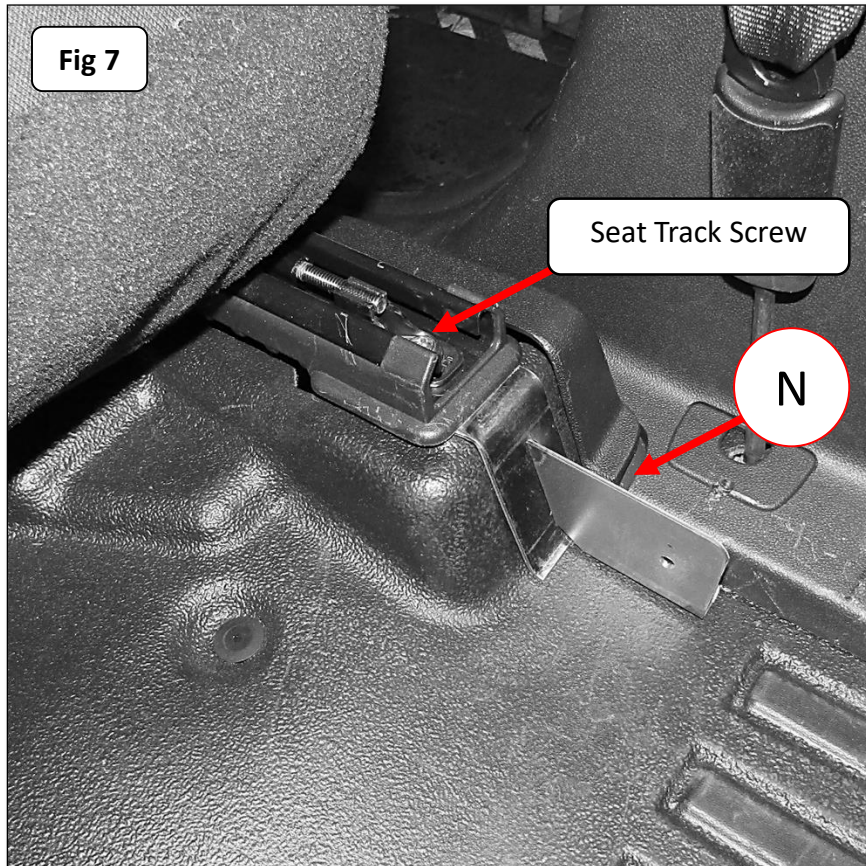
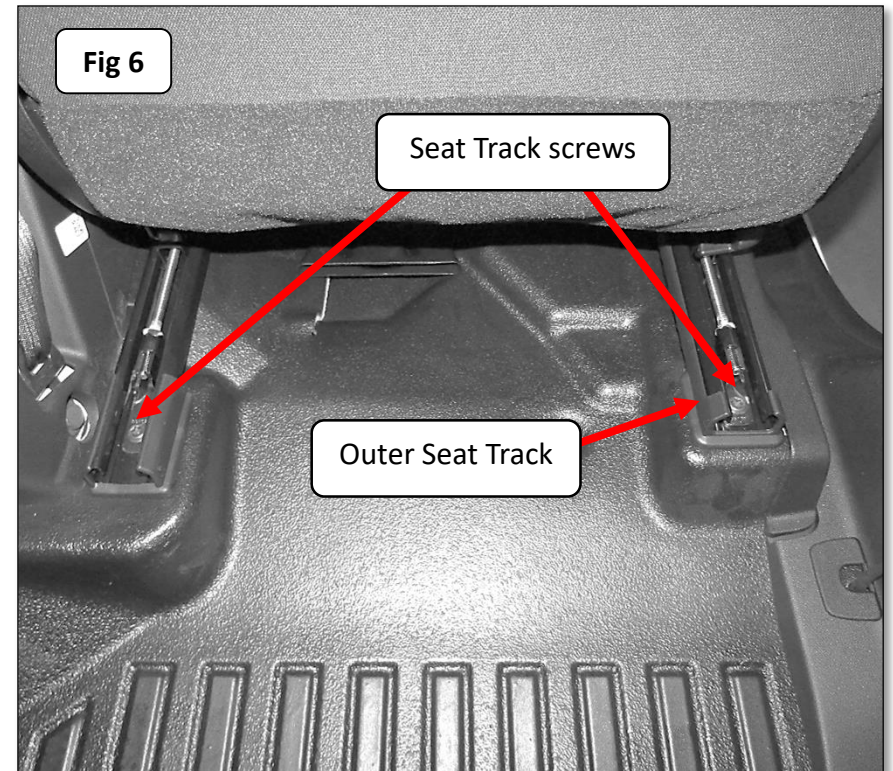

Step-9 Using a T50 Torx driver, remove the (4) screws from the front of the second row seat rails, (Fig 8).

Step-10 Tumble the seats forward. Using a T50 Torx driver, remove the (5) screws from the rear of the second row seat rails, (Fig 9).

Step-11 Remove both seats from the vehicle. Retain the second row seat screws as they will be reused.

Step-12 Remove the tire change tool kit, then use a 5.5mm socket to remove the stud from the floor of the vehicle.

Step-13 Unscrew and remove the plastic cap from the stud on the passenger side floor of the vehicle.

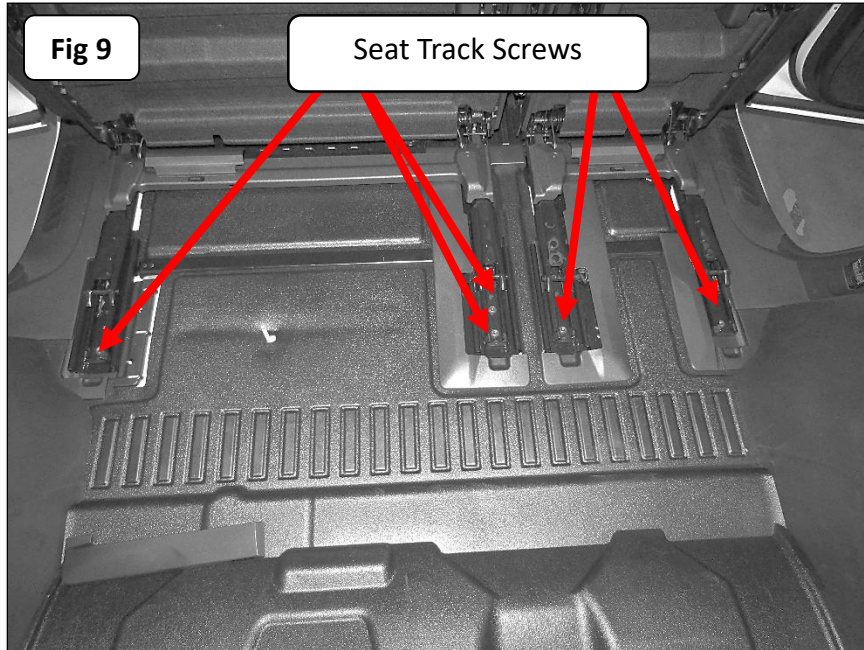
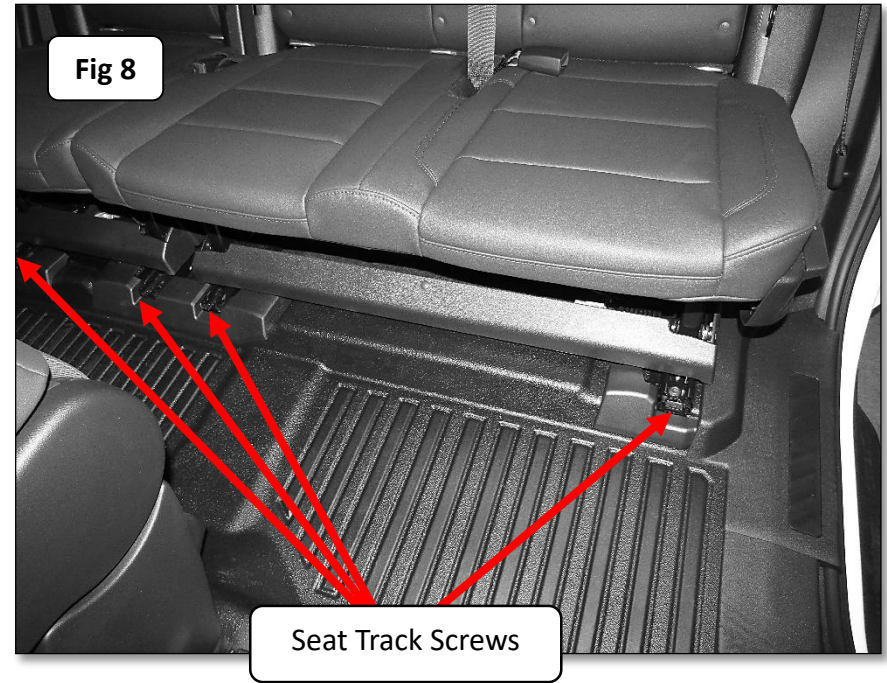

Step-14 Remove the plastic seat rail trim from the inboard rail of the passenger side rear seat, (Fig 10).

Step-15 Cut and remove the rear area of the seat rail trim attachment flange from the inboard rail assembly of the passenger side rear seat, (Fig 11). Note: Cut the seat rail trim attachment flange flush with the end of the rail.

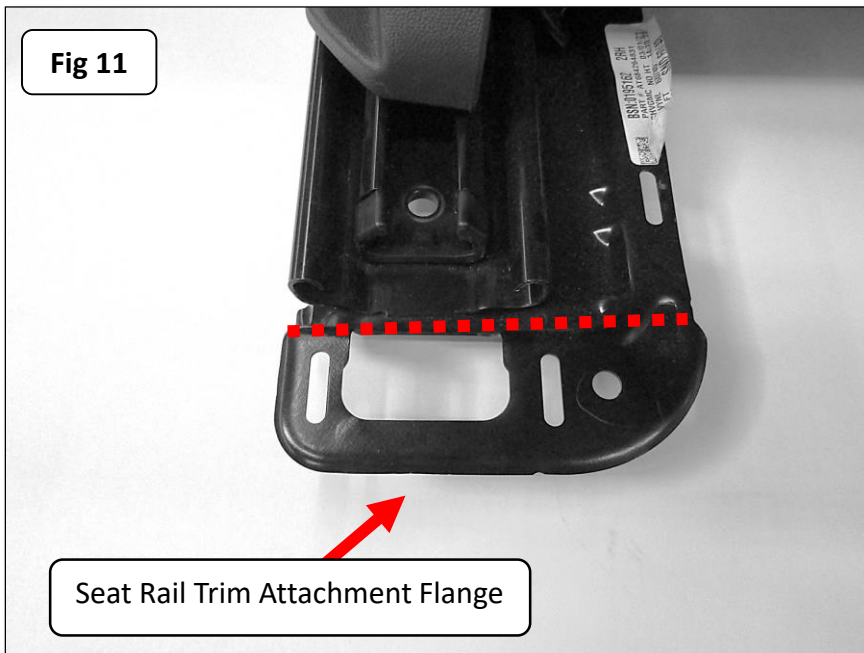
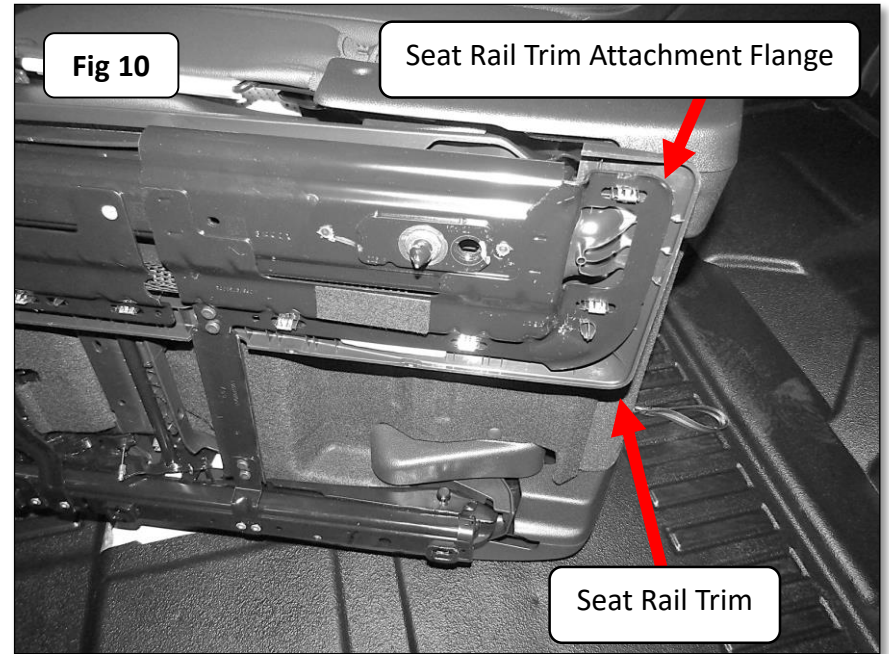

Step-16 On each side of the vehicle, use a razor knife to cut and remove the area shown from the rubber mat and pad, (Fig 12 & Fig 13).

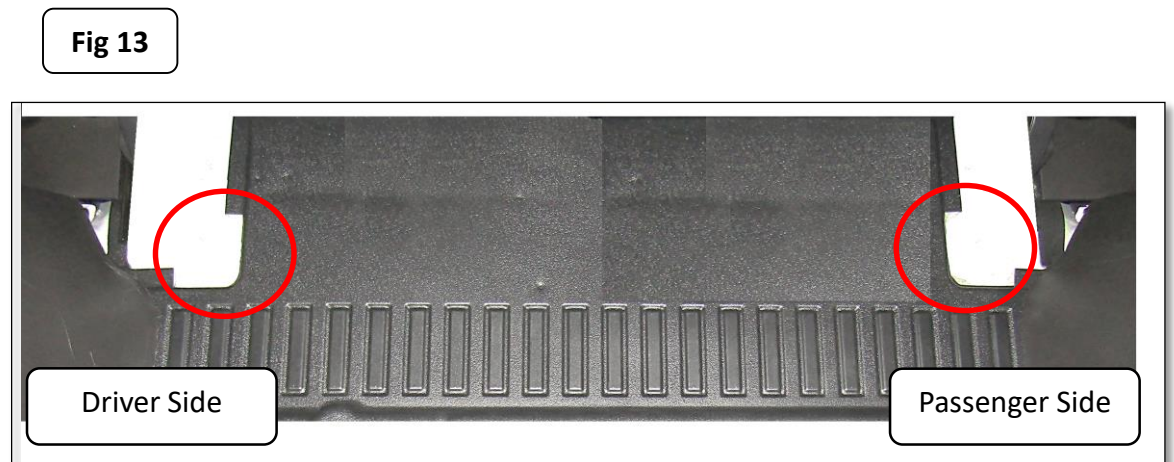
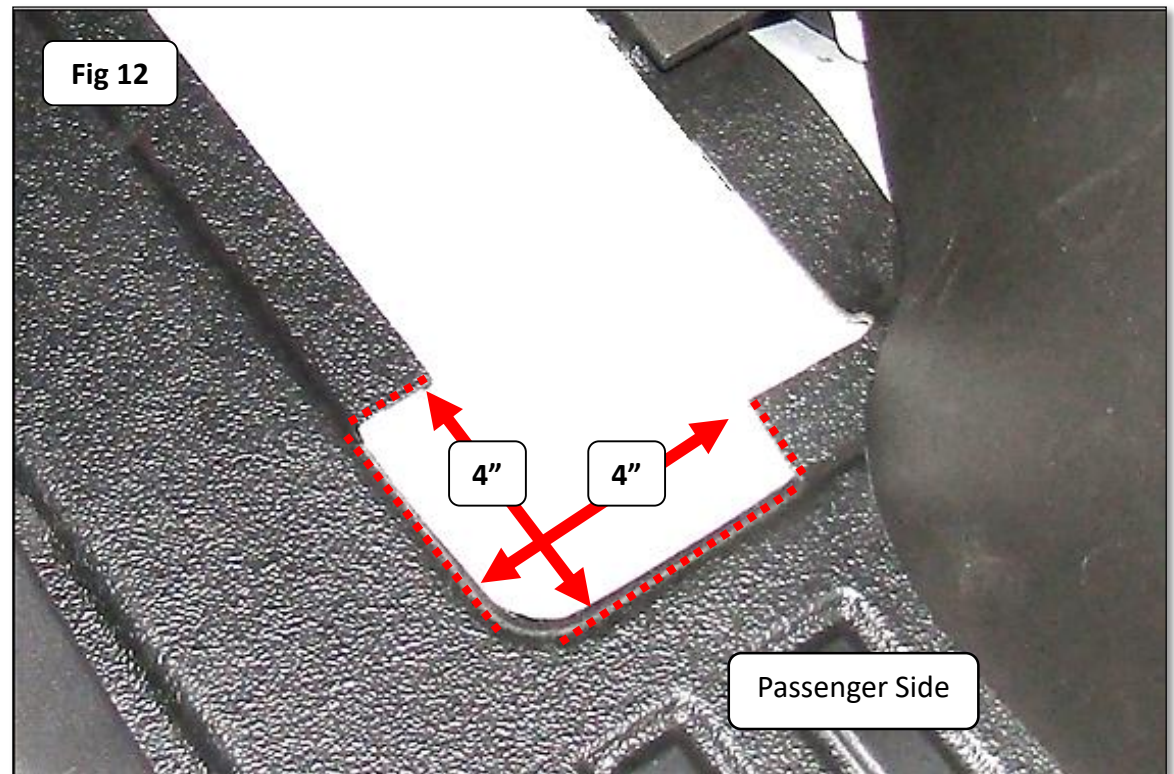

Step-17 On the driver side of the vehicle measure then use a razor knife to cut and remove the area shown from the rubber floor covering and pad for the Seat Adapter Brackets, (Fig 14).

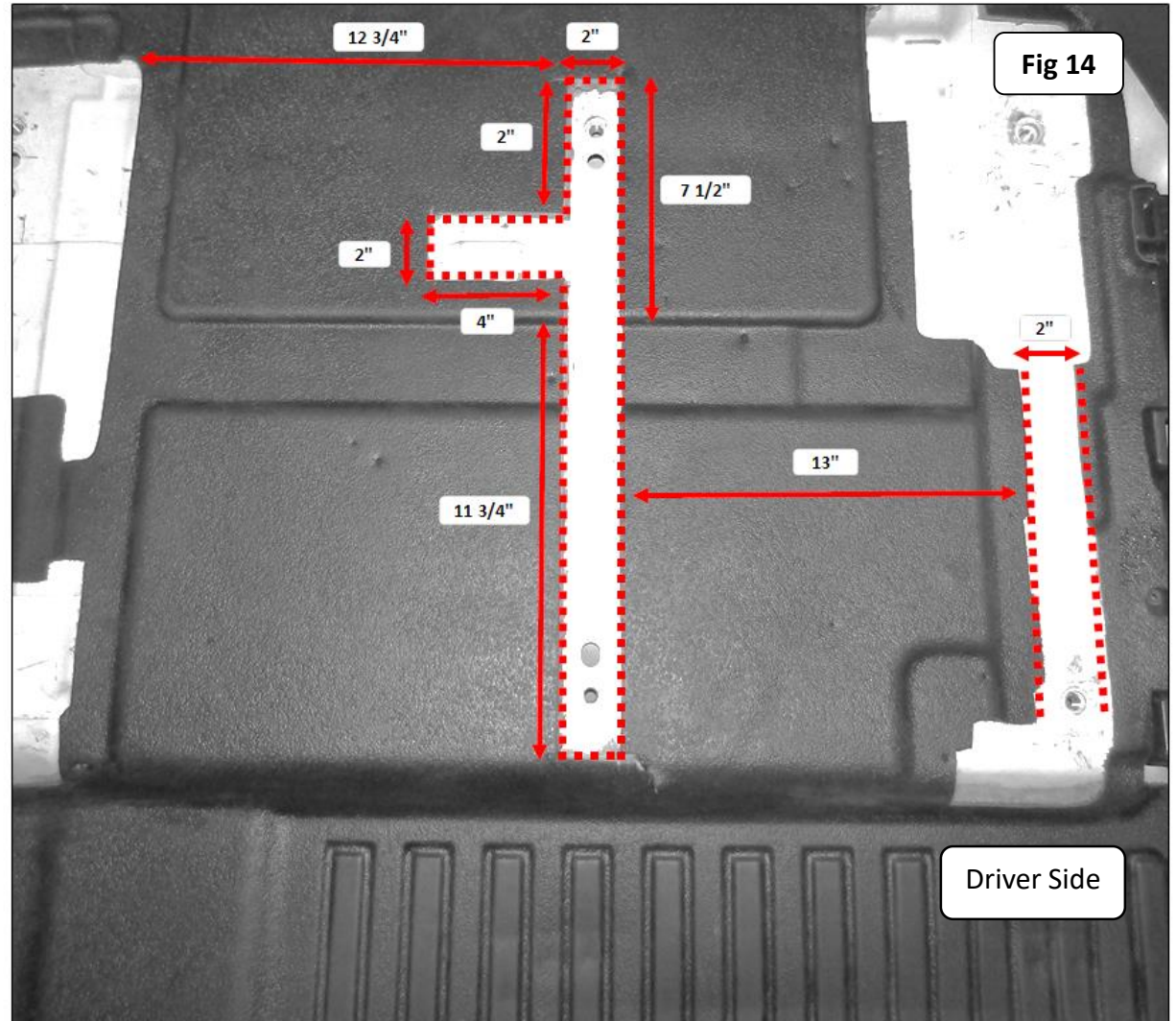

Step-18 On each side of the vehicle, measure and mark the attachment point location for the floor struts on the top side of the cargo area rubber mat, (Fig 15). Next use a 1" hole saw, and carefully apply enough pressure to only drill through the rubber mat and pad at the center of the marked location.

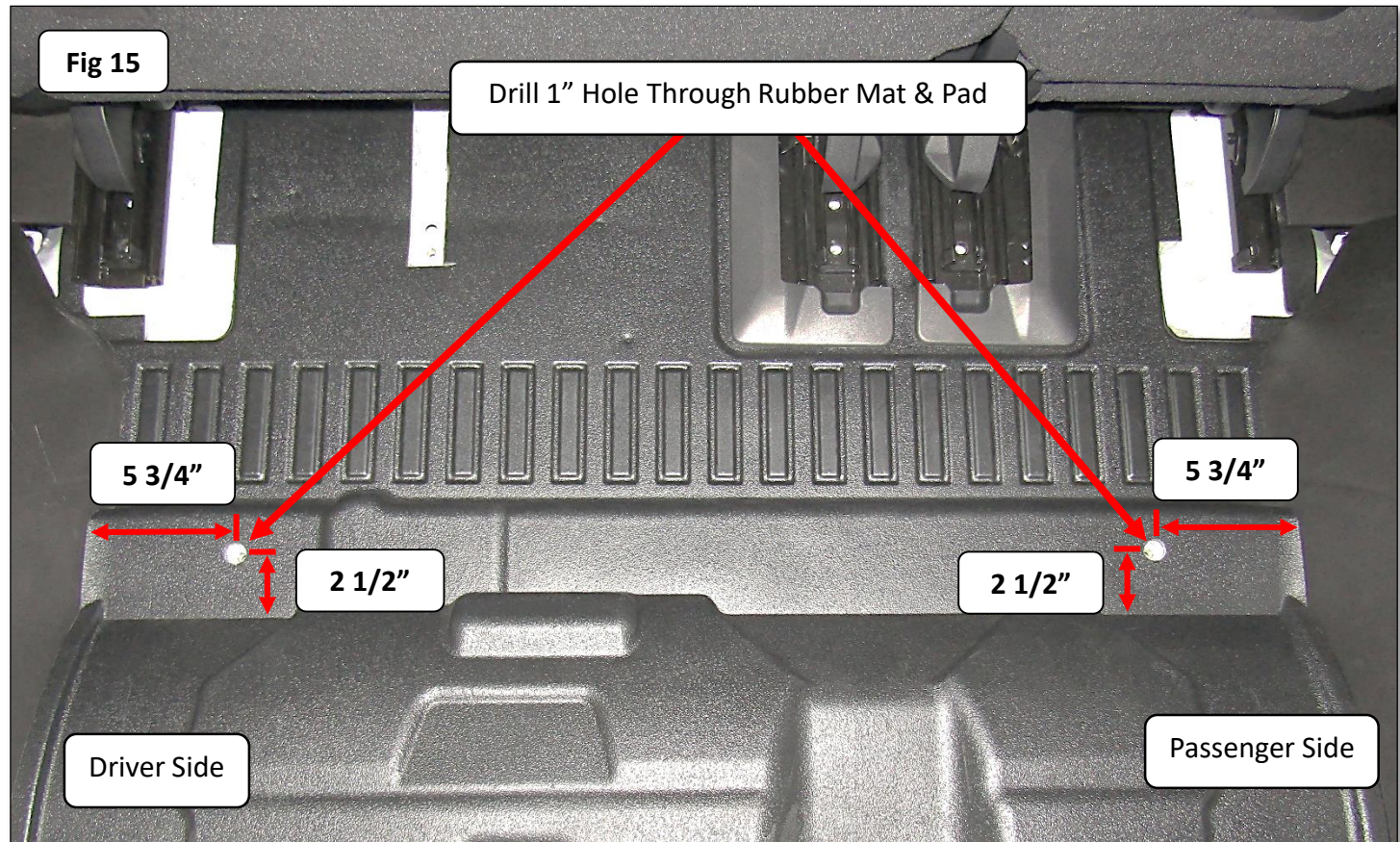

Step-19 Attach (1) Buckle to the Outer Buckle Bracket (right side) using (2) Button Head Hex Drive Screw, 1/4"-20 X 1", (2) Flat Washer 1/4" and (2) Nylon-Insert Locknut 1/4"-20, (Fig 16).

Note: Fully tightened the Button Head Screws and Nylon-Insert Locknuts, then loosen the Nylon-Insert Locknuts a full turn to allow the Buckle to slide freely front to back and tilt slightly from side to side on the Outer Buckle Bracket.

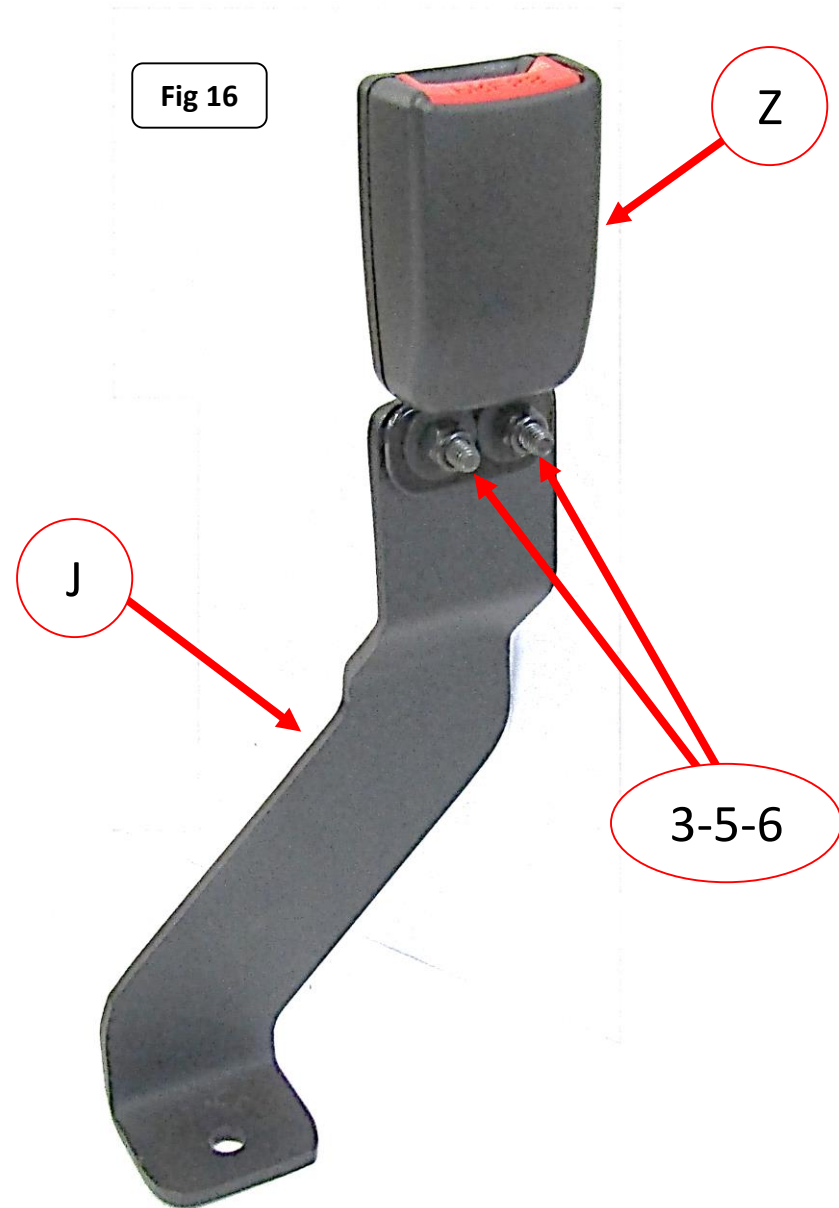
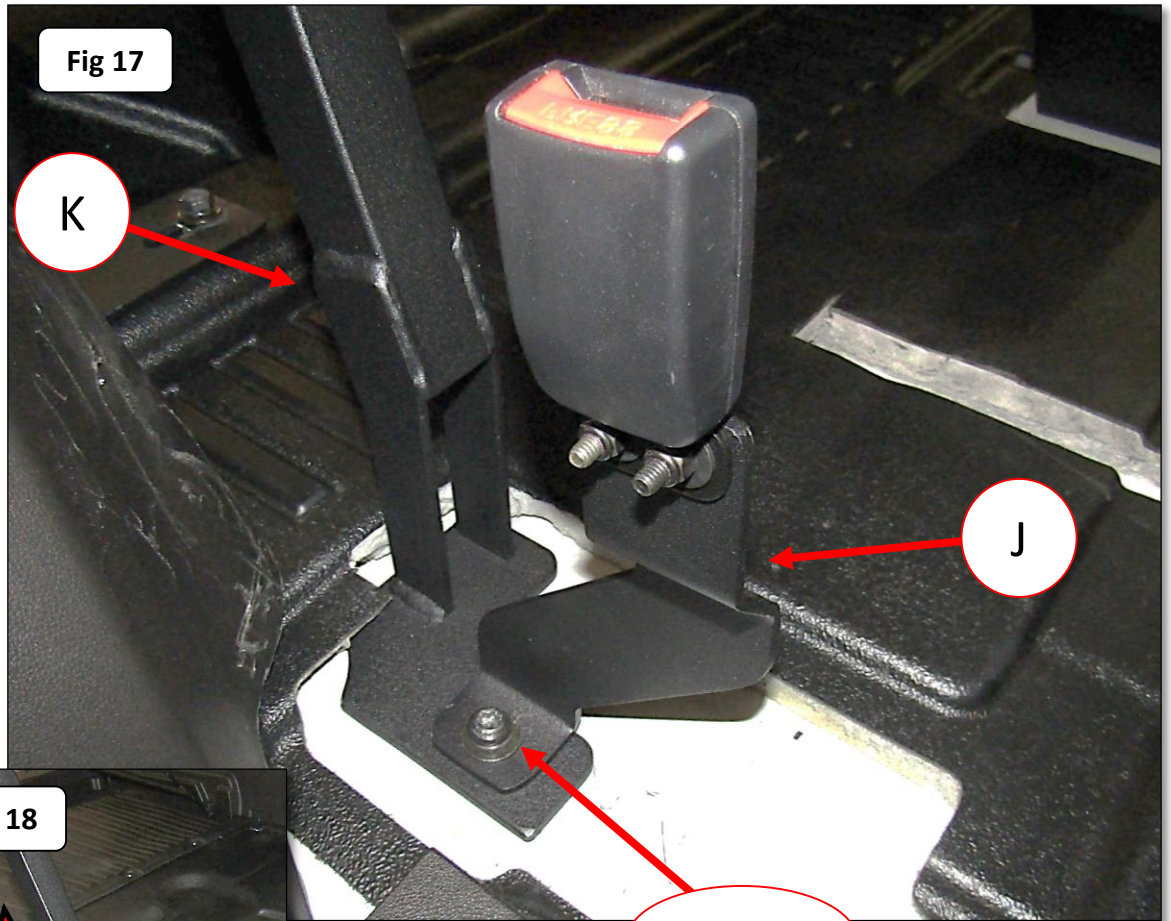
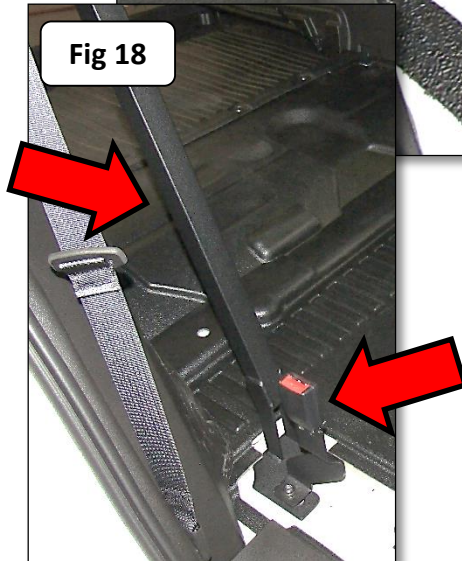

Fig 17



Step-20 With assistance, position the Rear Crossbar in the vehicle. Place the Outer Buckle Bracket (Right Side) and Buckle assembly on top of the Rear Crossbar foot bracket, Align the hole in the Outer Buckle Bracket and Rear Crossbar foot bracket with the threaded insert in the floor of the vehicle used for the rear seat rail attachment. Install (1) OEM Seat Screw, (1) Split Lock Washer M10 and (1) Flat Washer M10 to secure the Rear Crossbar and Outer Buckle Bracket in place, (Fig 17 & 18). Do not tighten the OEM Seat Screw.

Fig 18



14-15

OEM
Seat
Screw

Fig 19

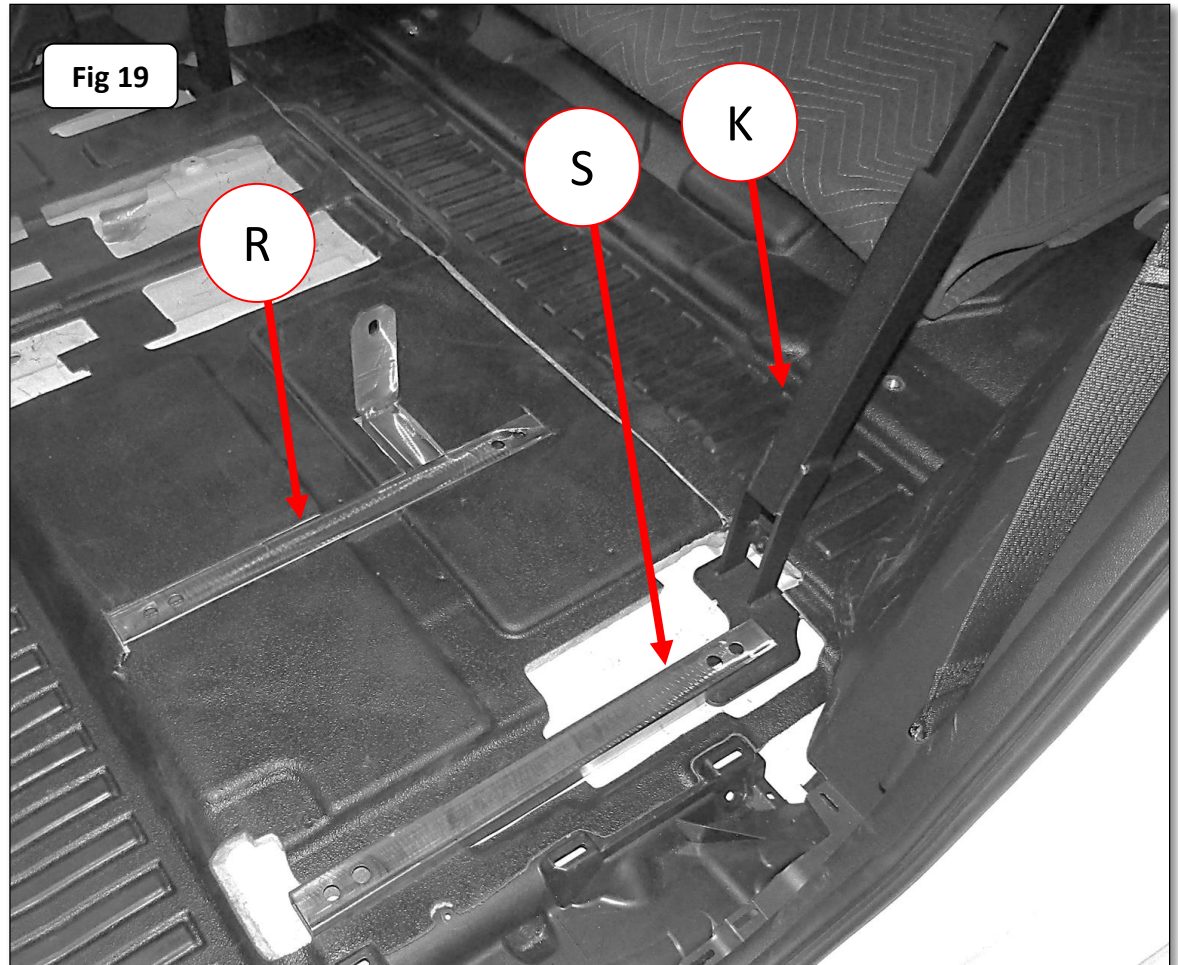

Step-22 Place the inner Seat Rail Adapter in the cutout in the rubber floor covering. Position the outer Seat Rail Adapter in the cutout in the rubber floor covering with the notch in the bottom of the adapter resting on top of the Rear Crossbar foot bracket, (Fig 19).

Step-23 With assistance, position the passenger side rear seat section on top of the Seat Rail Adapters. Align the holes in the rear seat rails, Seat Rail Adapters and Rear Cross Bar foot bracket with the threaded inserts in the floor of the vehicle, (Fig 20 & 21). Install (4) Button Head Screws M10-1.5 X 60MM to secure the rear seat section, Seat Rail Adapters and Rear Crossbar in place. Snug but do not tighten the screws.

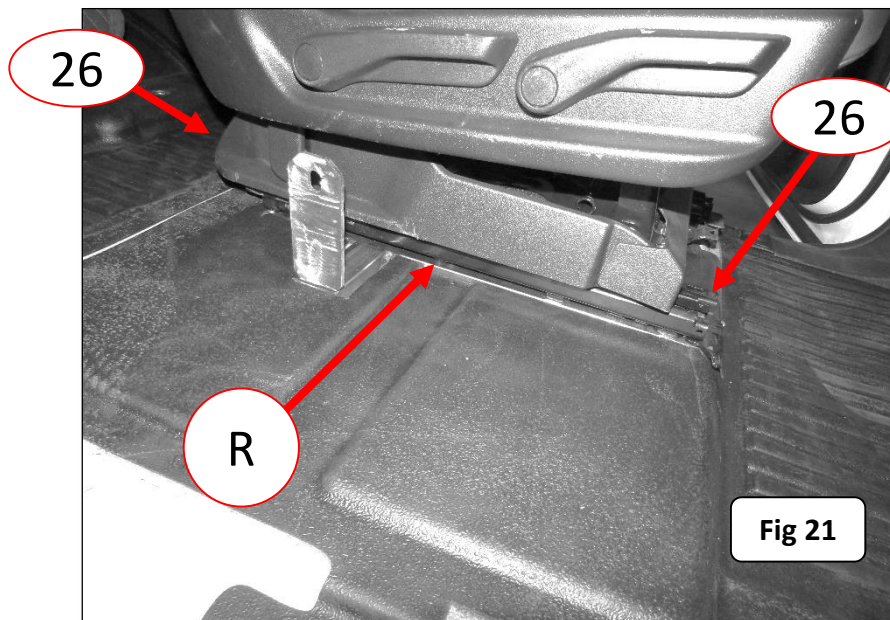
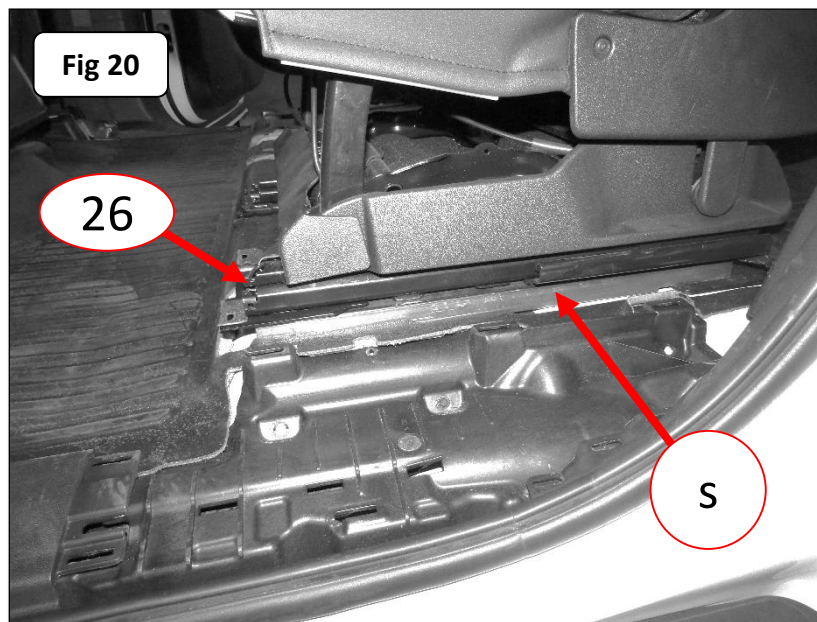
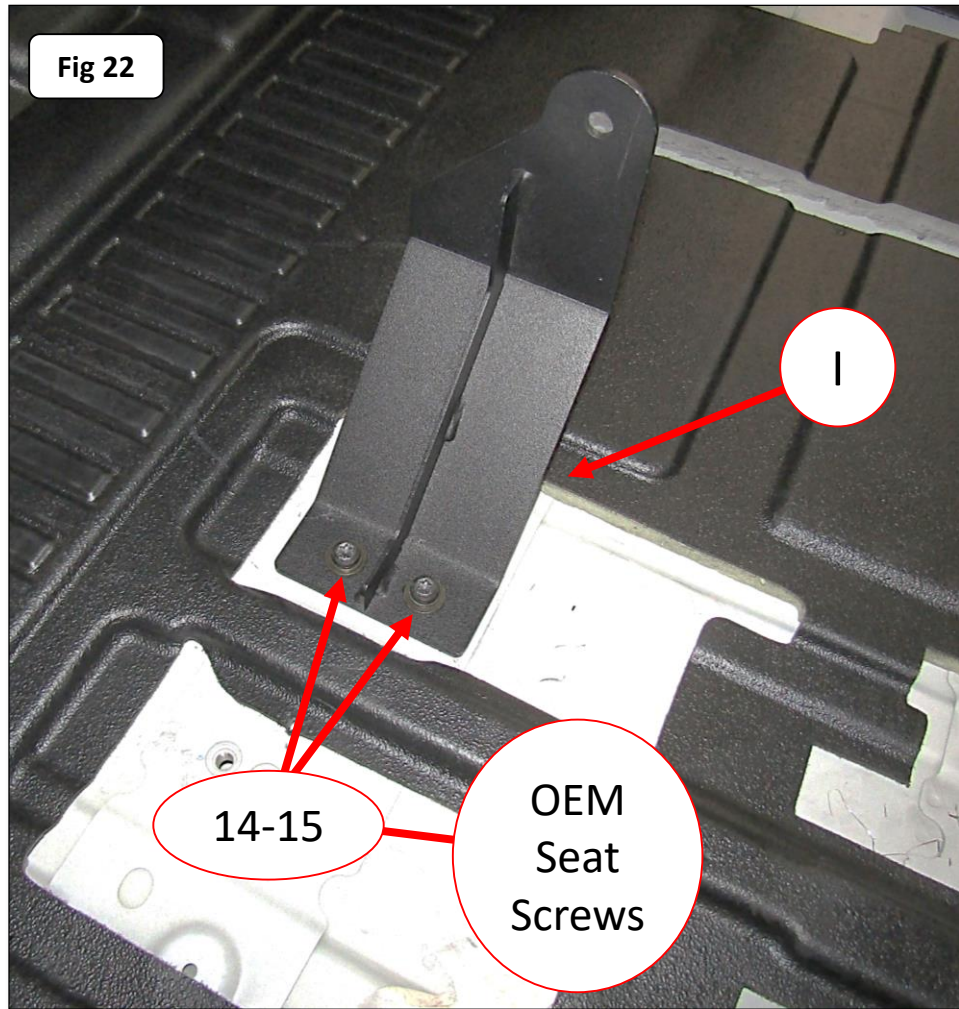
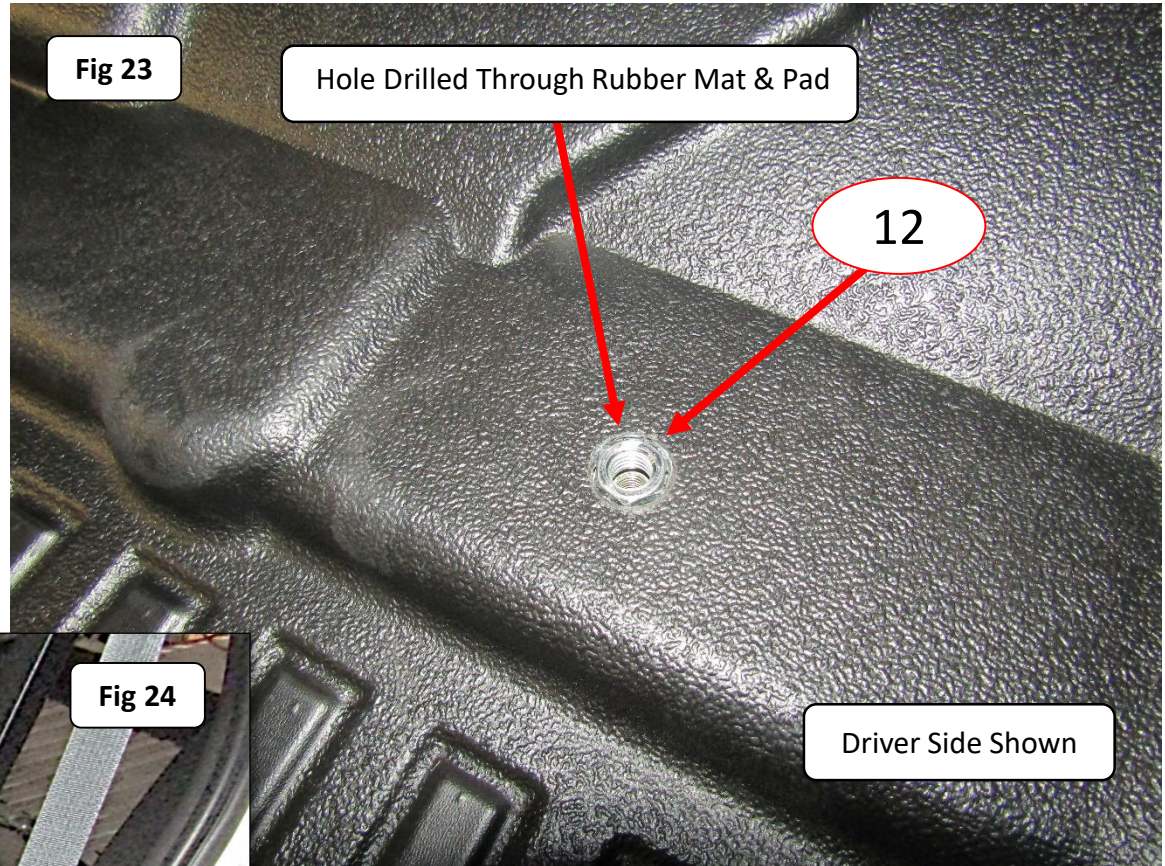

Fig 22

Step-24 Install Center Belt Bracket. Align the (2) slot holes in the Center Belt Bracket with the threaded inserts in the floor of the vehicle used for the rear seat rail attachment. Attach the Center Belt Bracket using (2) OEM Seat Screws, (2) Split Lock Washers M10 and (2) Flat Washers M10, (Fig 22). Do not tighten the OEM Seat Screws.





Step-25 Place (1) Hex Nut 1/2"-13 in each hole drilled through the rubber floor mat and pad, (Fig 23 & 24).

Note: The Hex Nut 1/2"-13 is used as a spacer.

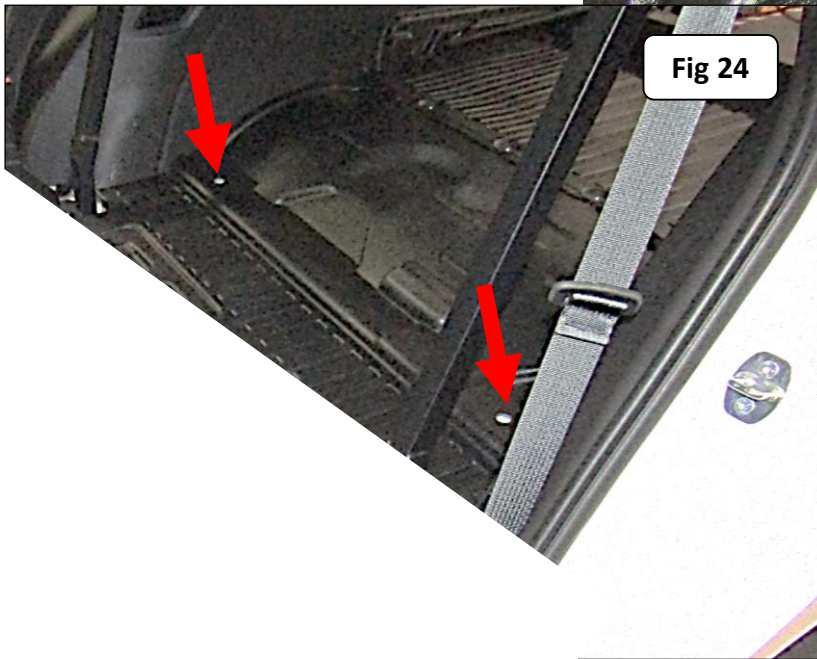

Step-26 Install the Floor Strut (Left Side). Align the slots in the upper bracket of the Floor Strut (Left Side) with the rivet-nuts installed in the vertical tube of the Rear Crossbar. Attach the Floor Strut (Left Side) to the vertical tube of the Rear Crossbar using (2) Hex Head Screw 1/4"-20 X 1 1/4", (2) Split Lock Washer 1/4" and (2) Flat Washer 1/4", (Fig 25 & 26). Do not tighten the Hex Head Screws.

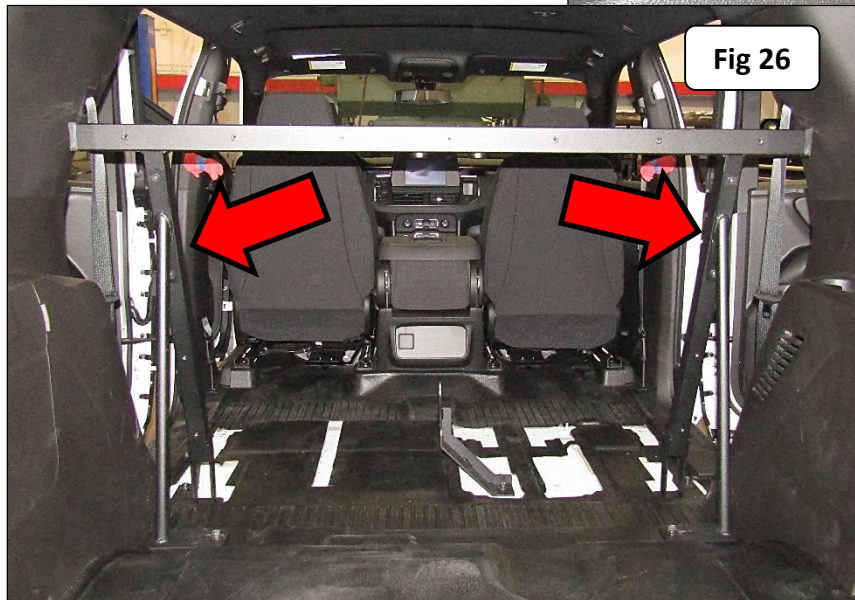
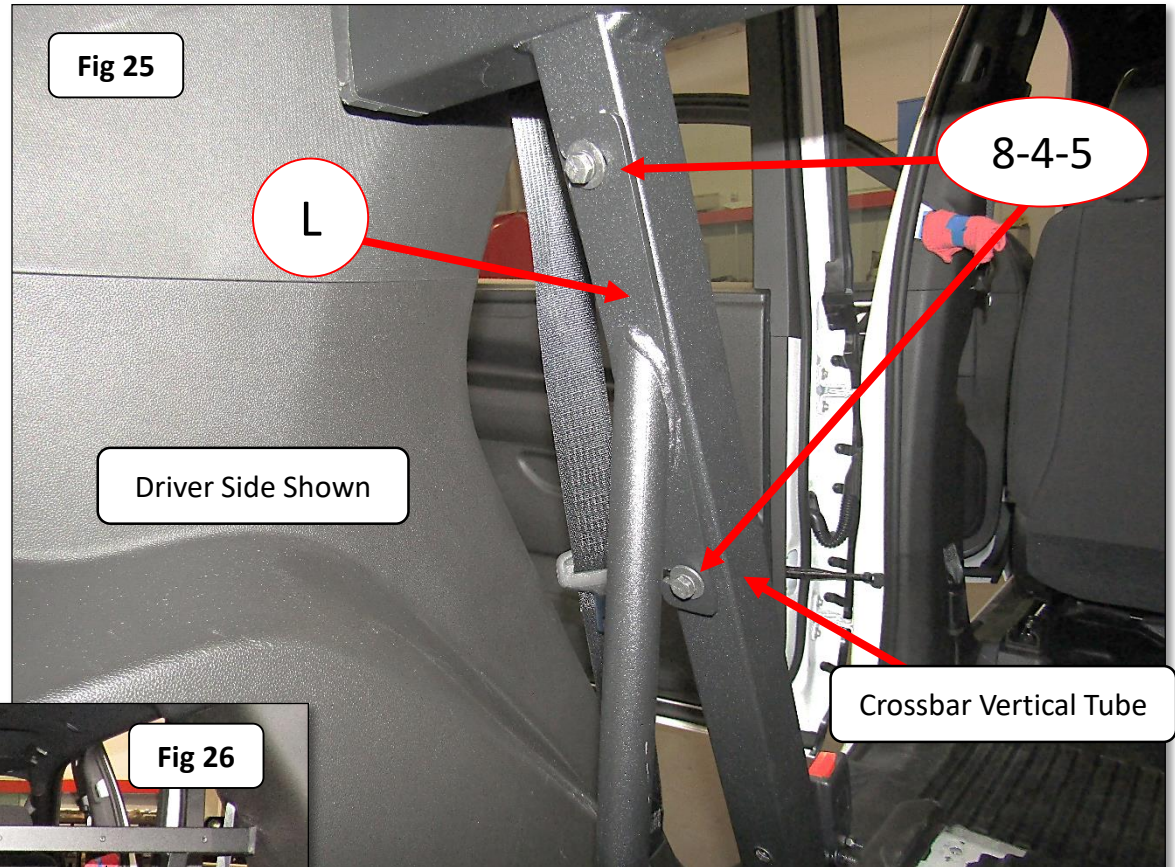
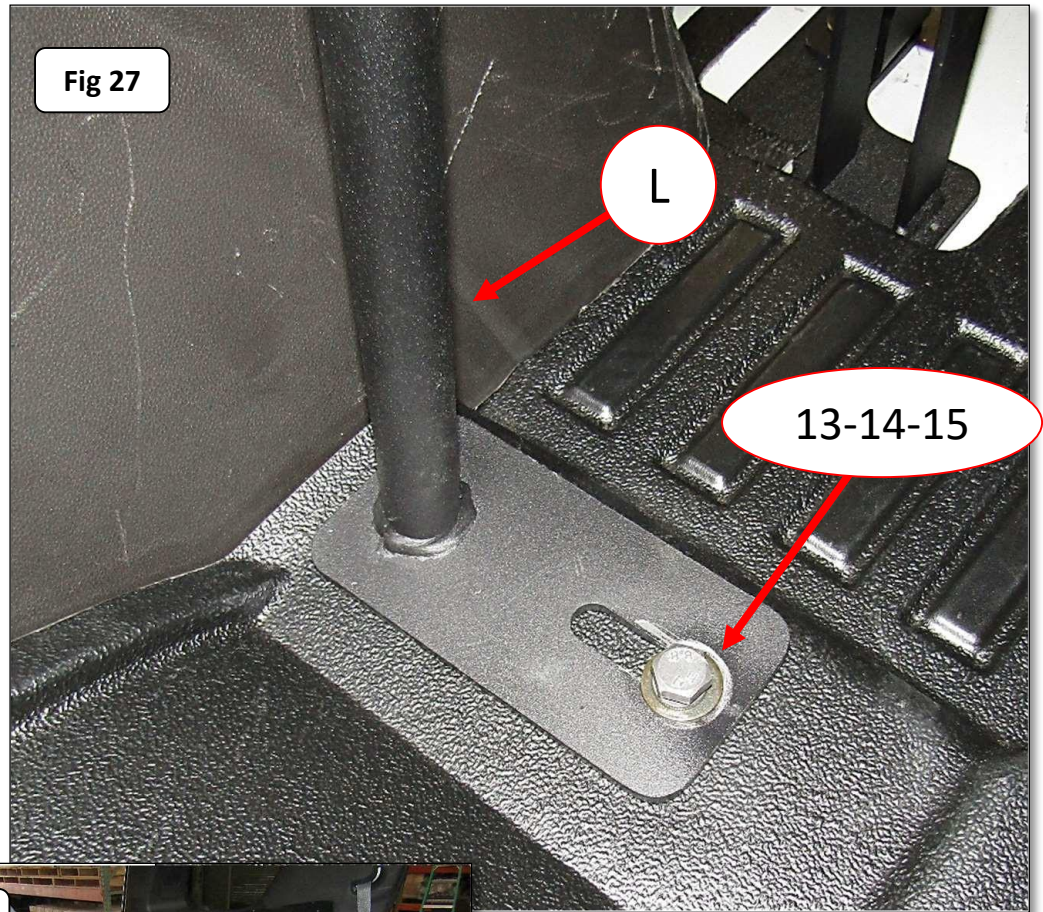

Fig 27



Step-27 Align the slot hole in the base plate at the opposite end of the Floor Strut (Left Side) with the Hex Nut $\frac{1}{2}$ "-13 placed in the rubber mat and the threaded insert in the floor of the vehicle. Attach the Floor Strut (Left Side) base plate to the floor of the vehicle using (1) Hex Head Screw M10-1.5 X 35MM, (1) Split Lock Washer M10 and (1) Flat Washer M10, (Fig 27 & 28). Do not tighten the Hex Head Screw. Repeat step 26 & 27 to install the Floor Strut (Right Side).

NOTE: Prior to tightening the Hex Head Screw adjust the strut either inboard or outboard to draw the mating upper edge of the Single Cell Seat against the C pillar.

Fig 28

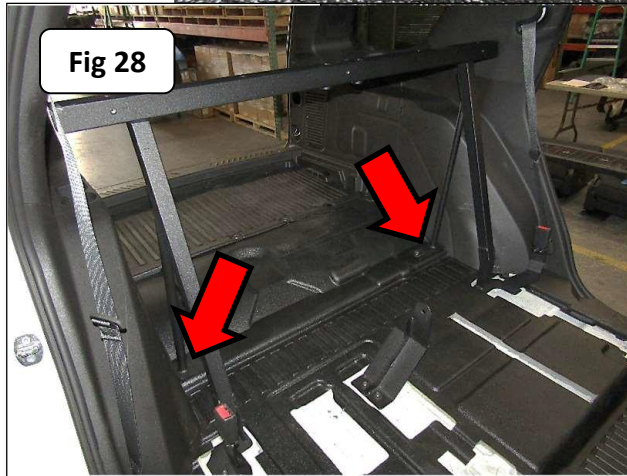

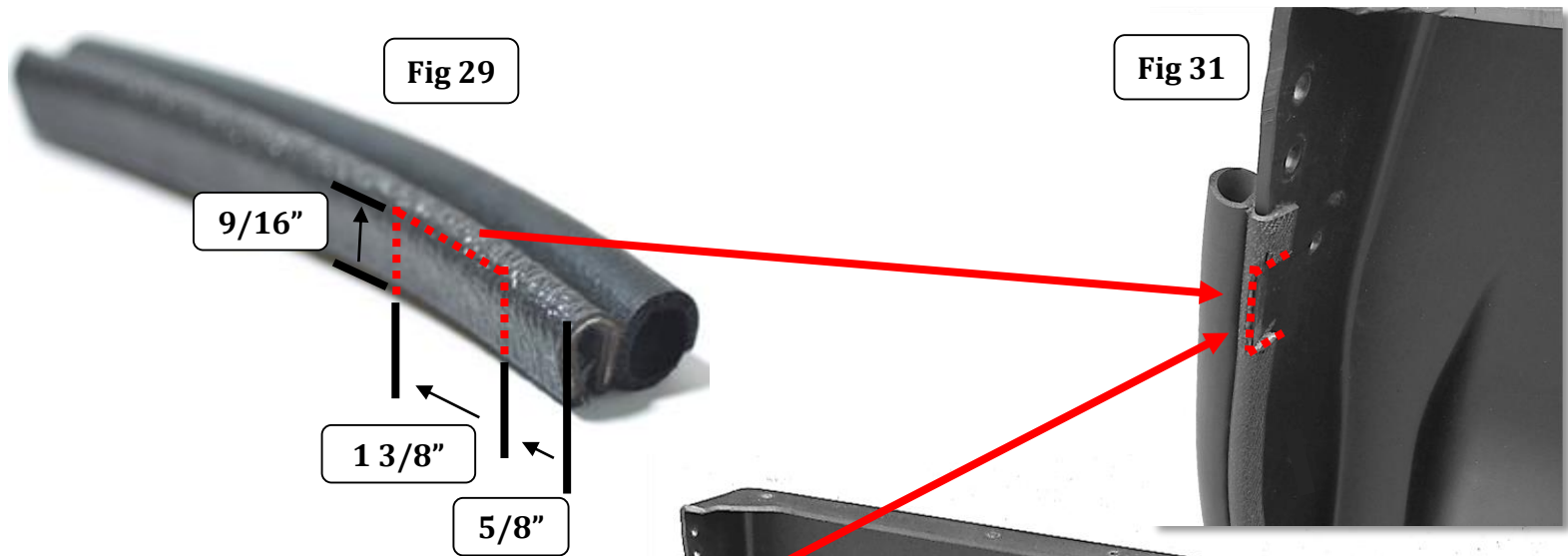

Step-28 Measure, mark, cut and remove the area from the Push-on Edge Trim attachment channel (Fig 29).

Step-29 Starting from the bottom, apply the Push-on Edge Trim by pressing the channel into place over the flange of the front lower panel, (Fig 30 & 31).

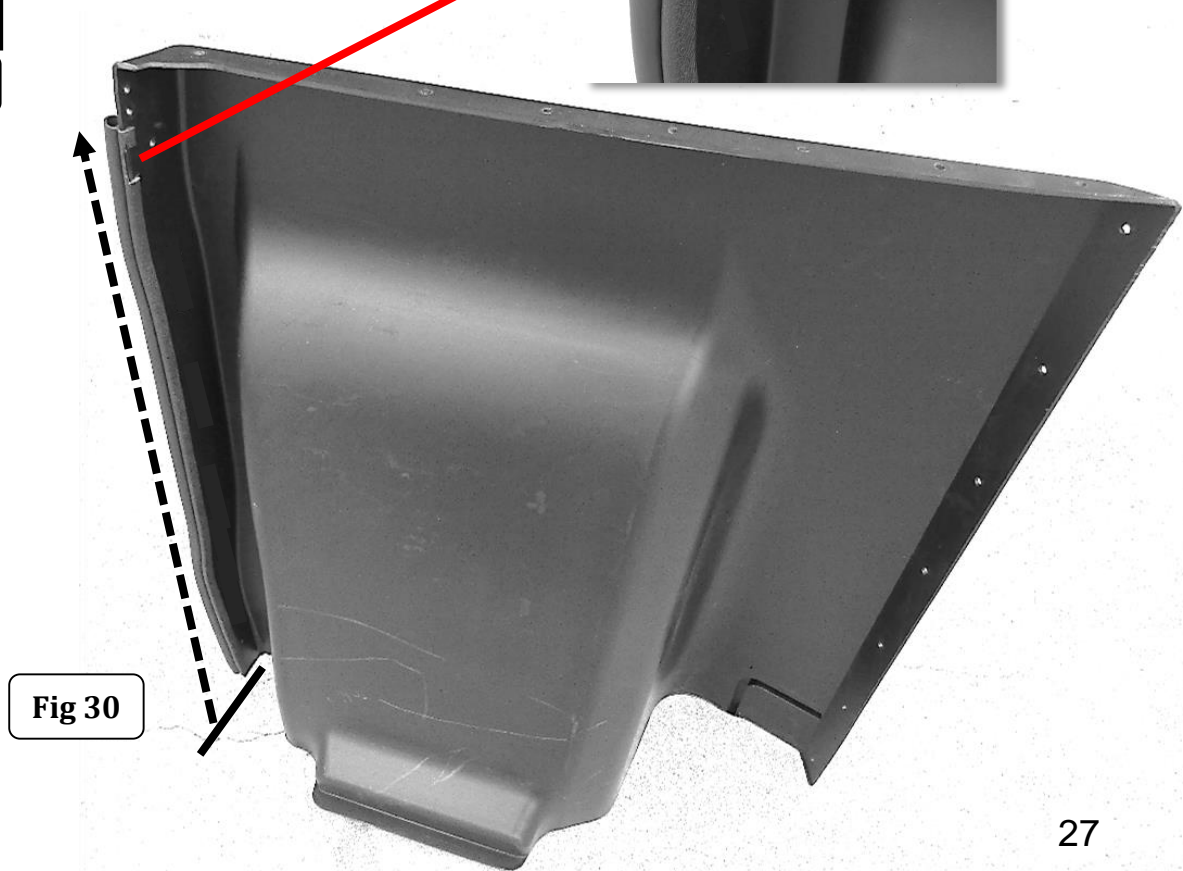

Step-30 Position the Single Cell Front Lower Panel on the outside of the Lower B-Pillar Bracket, and attach the Single Cell Front Lower Panel to the Lower B-Pillar Bracket using (1) Button Head Hex Drive Screw 1/4"-20 x 1", (2) Flat Washer 1/4" and (1) Nylon-Insert Locknut, 1/4"-20", (Fig 32 & 33). Finger tighten.

Step-31 Attach the Single Cell Front Lower Panel to the Foot Bracket using (1) Button Head Hex Drive Screw 1/4"-20 x 1" and (1) Flat Washer 1/4", (Fig 34 & 35). Finger tighten.

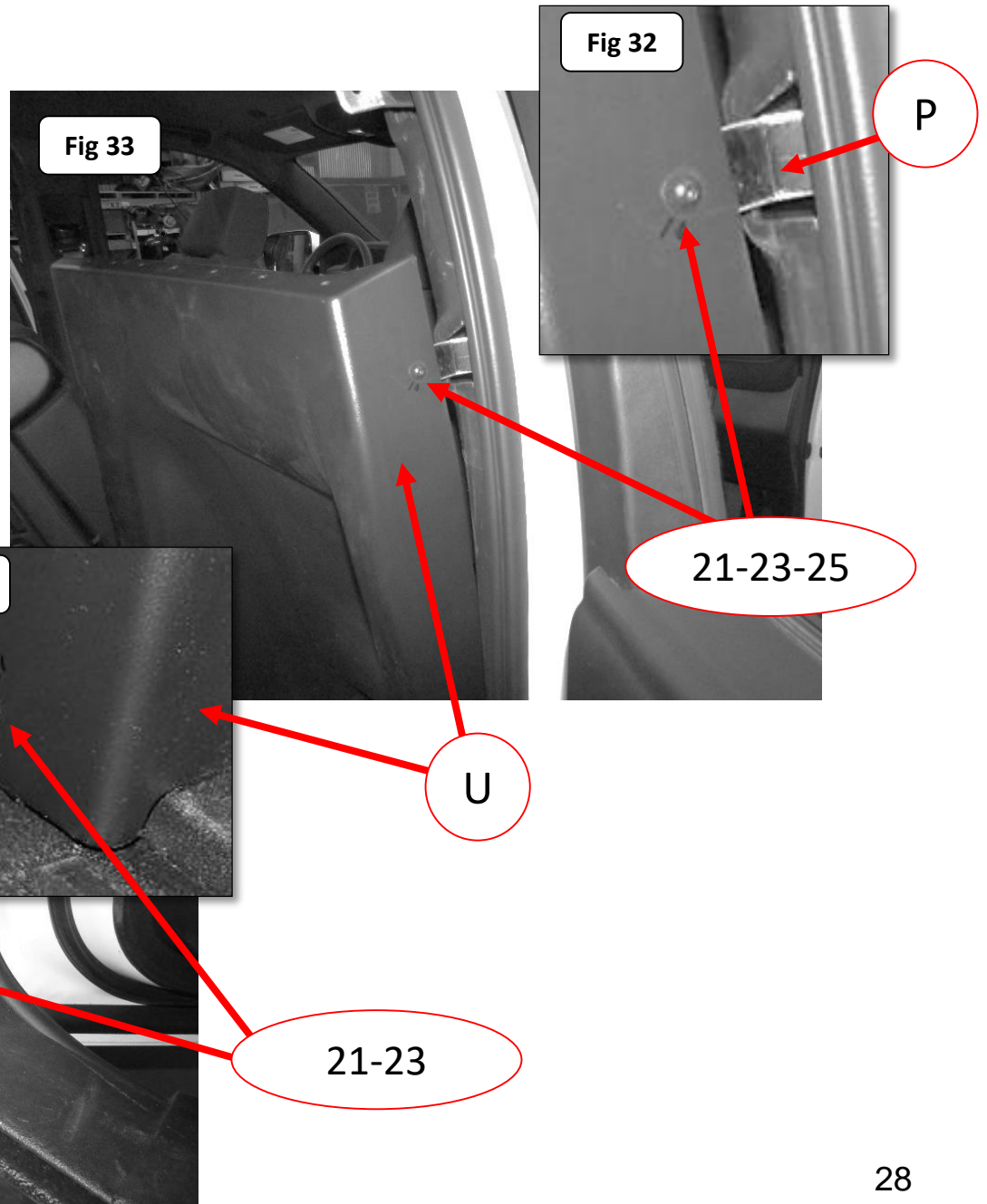

Step-32 Single Cell Center Lower Panel to the Single Cell Front Lower Panel. Attach the Single Cell Center Lower Panel to the Single Cell Front Lower Panel using (7) Button Head Hex Drive Screws, 1/4"-20 X 3/4", (14) Flat Washers 1/4" and (7) Nylon-Insert Locknut, 1/4"-20", (Fig 36 & 37). Finger tighten only. Note: Feed bolt and washer from the front of the vehicle to the rear. One washer will be on the bolt side and one washer will be on the nut side. Use of the alignment punch may be required to shift the component attachment holes into alignment for inserting the fasteners.

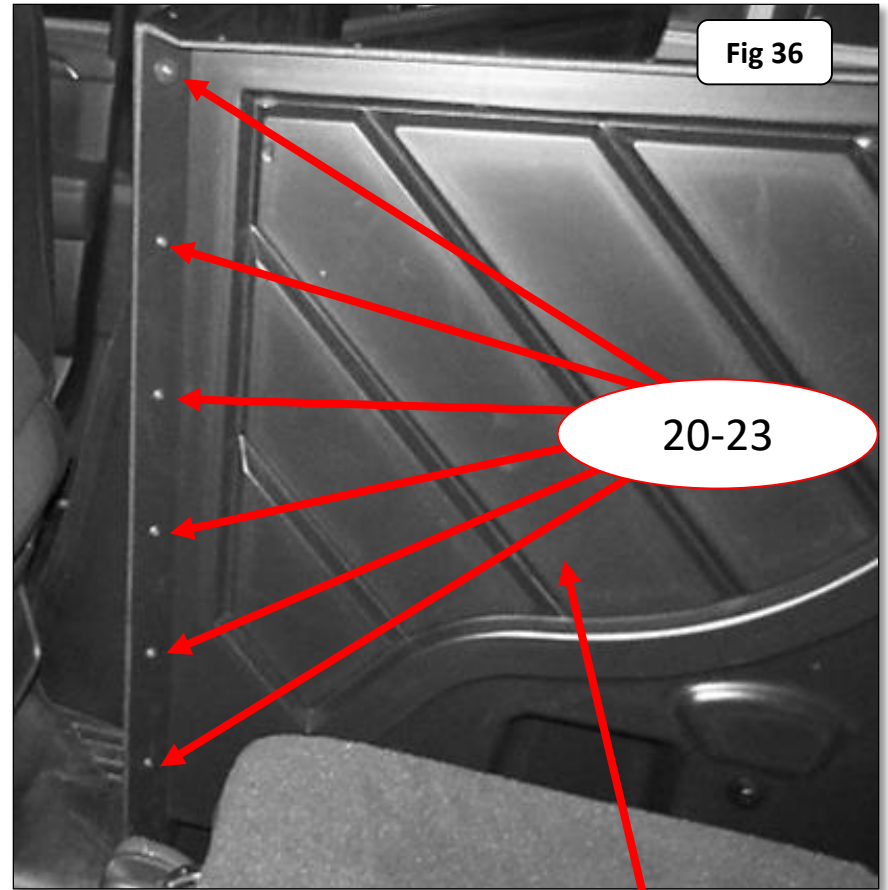
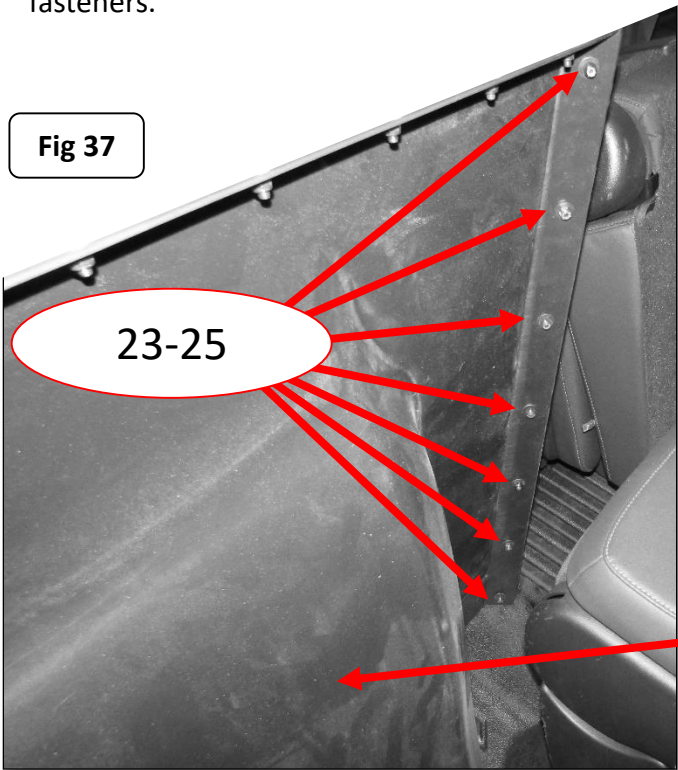

Step-33 Front Upper Panel to Front Lower Panel. Remove protective film from the Single Cell Front Upper Panel and attach the Single Cell Front Upper Panel to the top of the Single Cell Front Lower Panel using (8) Button Head Hex Drive Screws, 1/4"-20 x 1", (16) Flat Washers 1/4" and (8) Nylon-Insert Locknut, 1/4"-20", (Fig 38 & 39). Finger tighten only. Note: Feed the bolt and washer down through the Single Cell Front Upper Panel and Single Cell Front Lower Panel then fasten with one washer and nut. Use of the alignment punch may be required to shift the component attachment holes into alignment for inserting the fasteners.

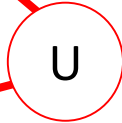
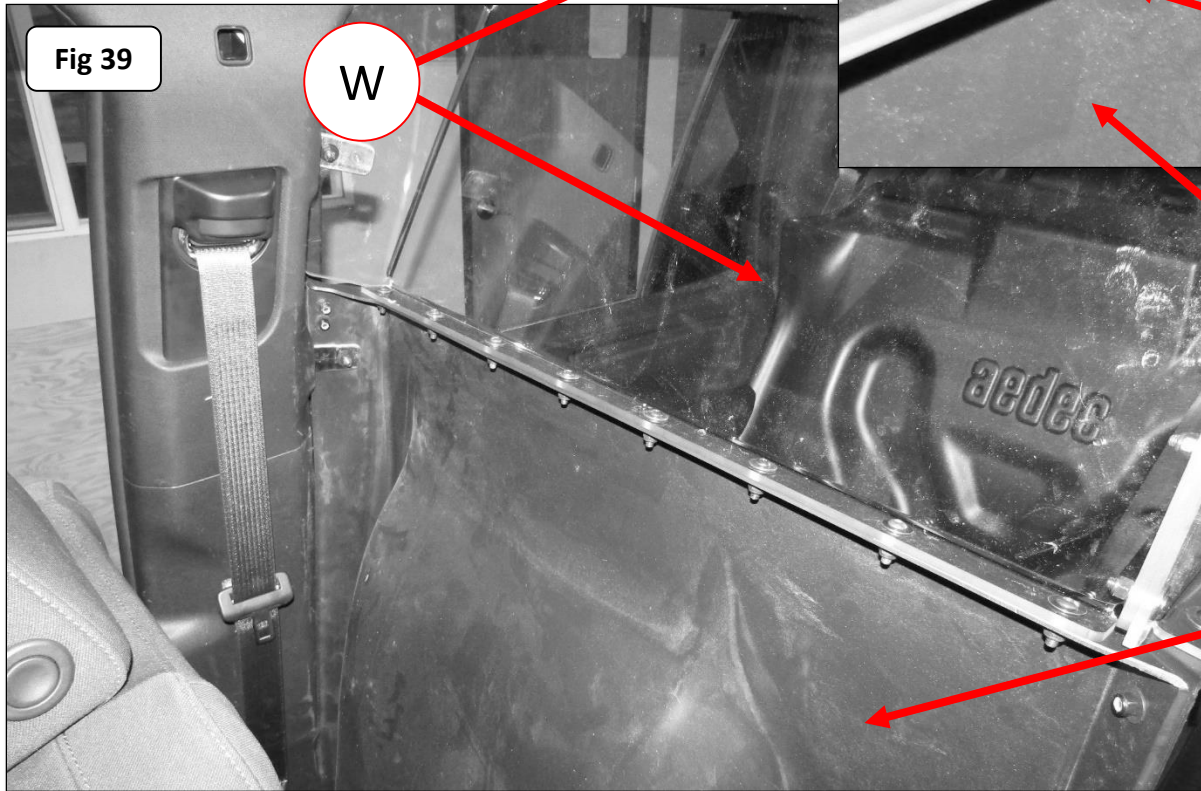
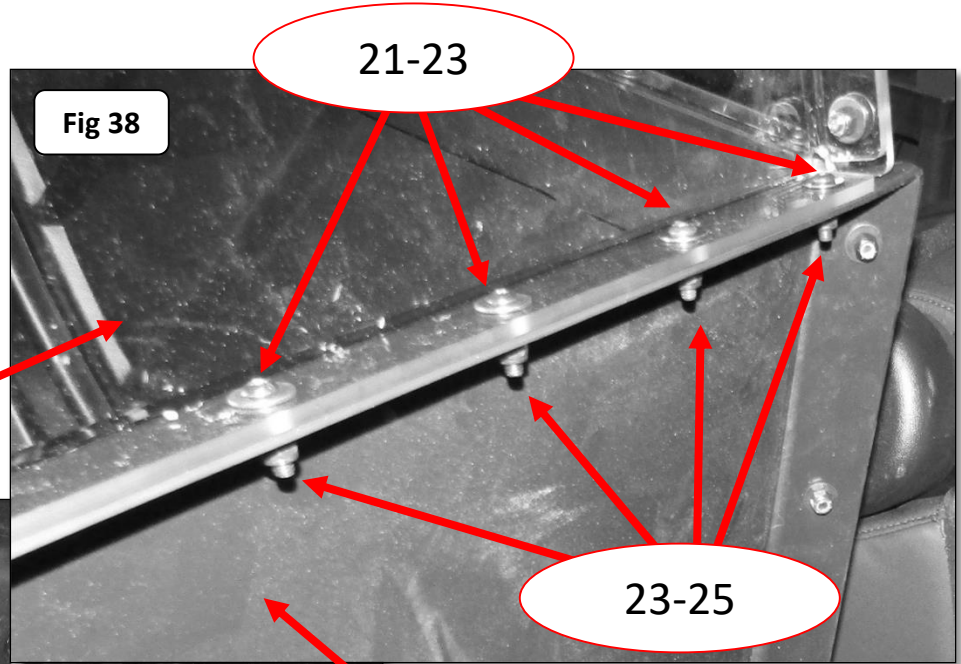

Step-34 Center Upper Panel to Center Lower Panel. Remove protective film from the Single Cell Center Upper Panel and attach the Single Cell Center Upper Panel to the top of the Single Cell Center Lower Panel using (9) Button Head Hex Drive Screws, 1/4"-20 x 1", (18) Flat Washers 1/4" and (9) Nylon-Insert Locknut, 1/4"-20", (Fig 40 & 41). Finger tighten only. Note: Feed the bolt and washer down through the Single Cell Center Upper Panel and Single Cell Center Lower Panel then fasten with one washer and nut. Use of the alignment punch may be required to shift the component attachment holes into alignment for inserting the fasteners.

21-23

Fig 40

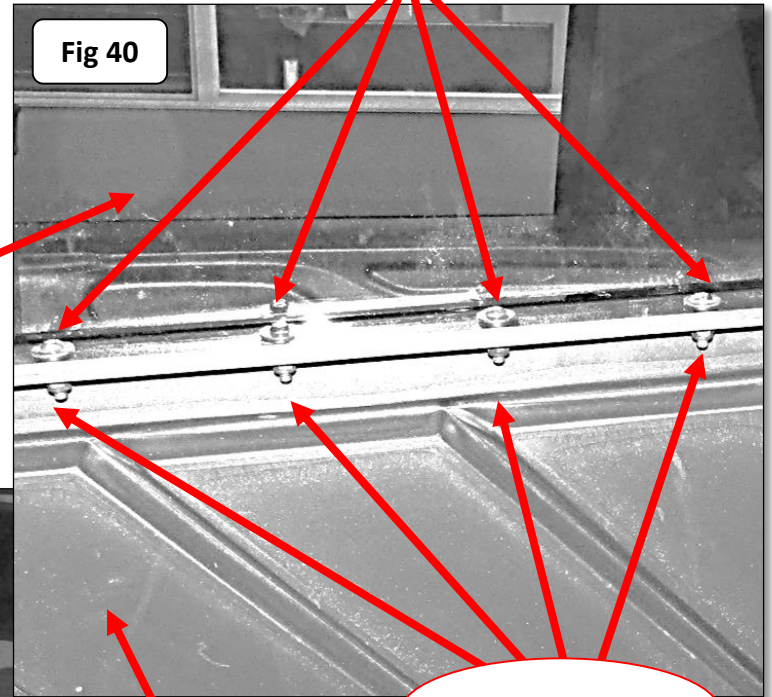

23-25

X

Fig 41



V

Step-35 Front Upper Panel to Center Upper Panel. Attach the Single Cell Front Upper Panel to the Single Cell Center Upper Panel using (5) Button Head Hex Drive Screws, 1/4"-20 x 1", (10) Flat Washers 1/4" and (5) Nylon-Insert Locknut, 1/4"-20", (Fig 42). Finger tighten. Use of the alignment punch may be required to shift the component attachment holes into alignment for inserting the fasteners.

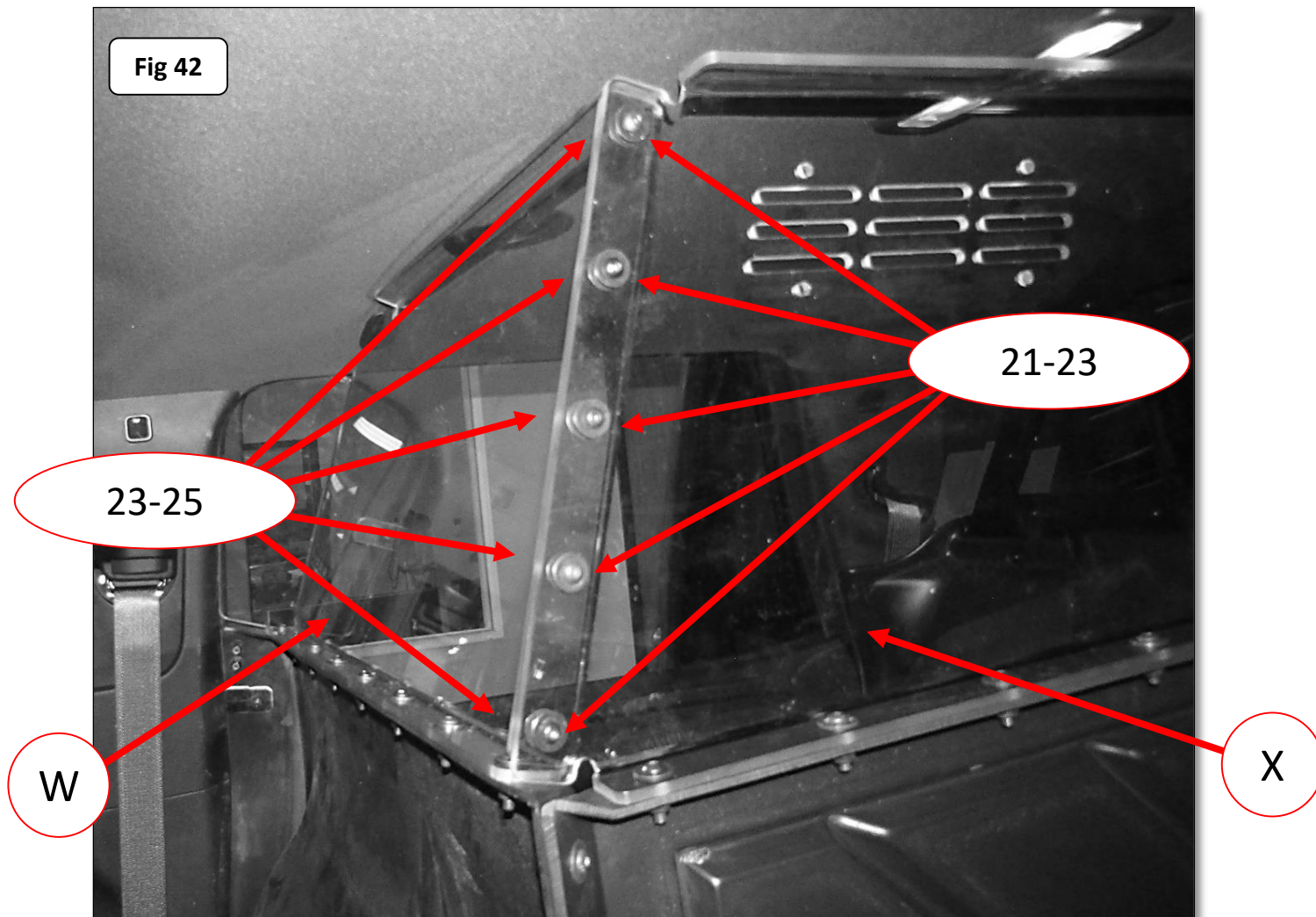

Step-36 Position the Single Cell Front Upper Panel on the outside of the Upper B-Pillar Bracket, and attach the Single Cell Front Upper Panel to the Upper B-Pillar Bracket using (1) Button Head Hex Drive Screw 1/4"-20 x 1", (2) Flat Washer 1/4" and (1) Nylon-Insert Locknut, 1/4"-20", (Fig 43 & 44). Finger tighten.

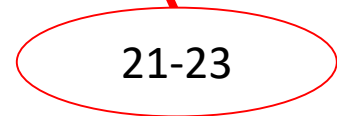
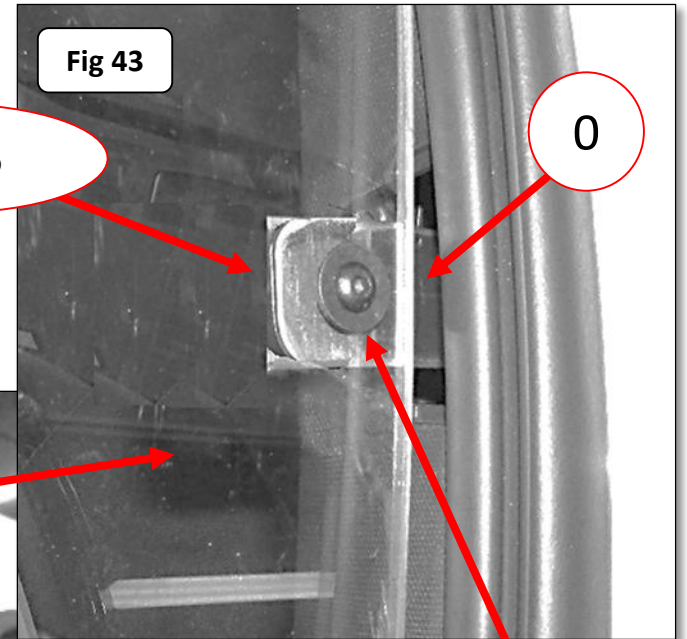

Step-37 With assistance, place the Single Cell Seat in the vehicle so the Buckle attached to the right side Buckle Bracket protrudes through the rectangular opening in the Seat.

Step-38 Take the 3 Point Belt, and feed the (silver) anchor plate of the waist belt end through the seat belt slot at the inboard side of the Single Cell Seat, (Fig 45).

Step-39 This process will require two people. Pull the top of the Single Cell Seat forward to expose the mounting hole for the belt located in Lower Center Panel. From the Driver Side of the rear seat compartment, opposite side of image. Insert (1) Hex Head Cap Screw 1/2"-13 x 1 1/2", (1) Flat Washer 1/2" through the hole in the Lower Center Panel, Center Belt Bracket and the 3-Point Belt anchor plate. Fasten using (1) Flat Washer 1/2" and (1) Nylon-Insert Locknut, 1/2"-13, (Fig 46). Tighten Securely.

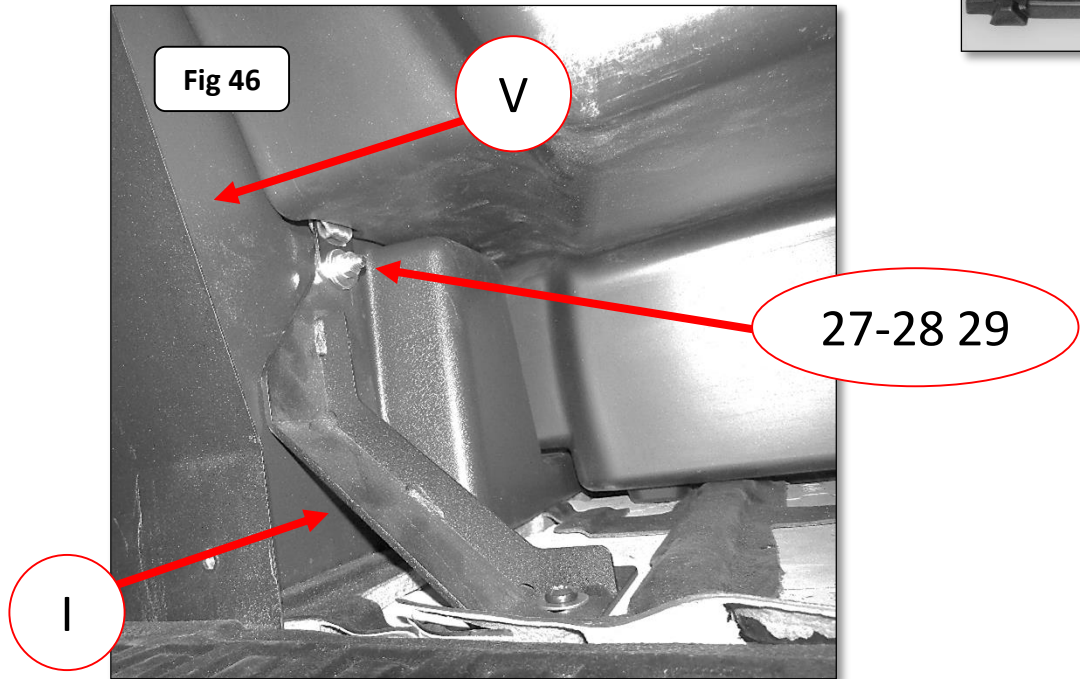
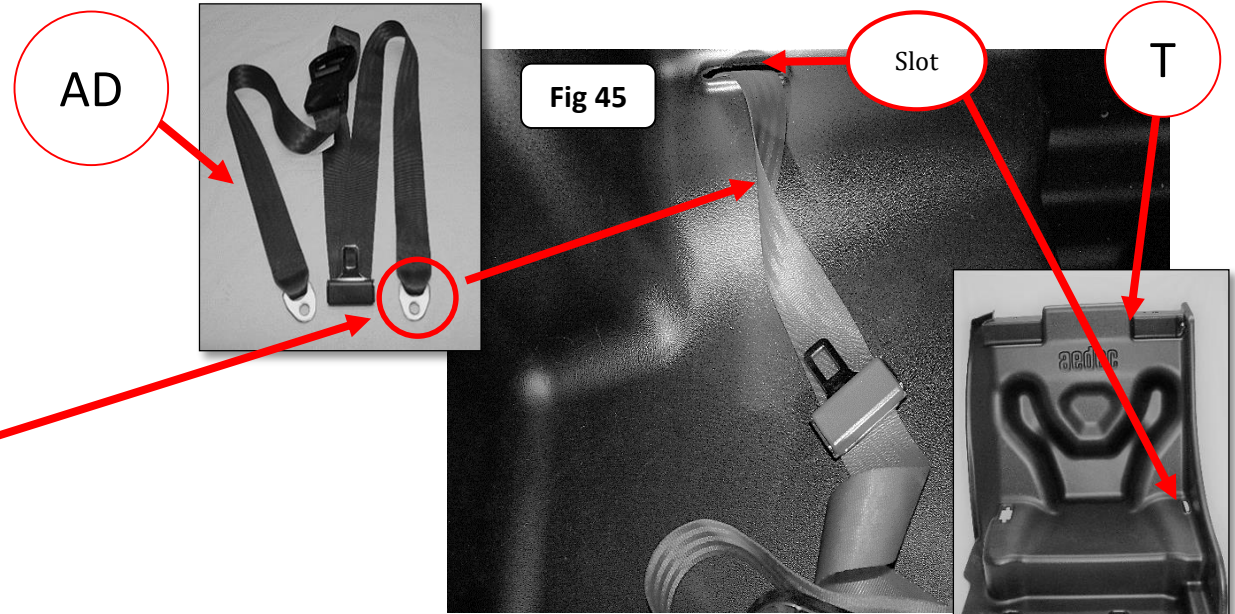

Step-40 Maneuver the Single Cell Seat into its correct position. Ensure the Buckle is completely through the buckle slot in the seat, (Fig 47).

Align the (2) holes in the upper front area of the Seat with the rivet-nuts installed in the Rear Crossbar and attach the Seat to the Rear Crossbar using (2) Button Head Hex Drive Screws, 1/4"-20 X 1" and (2) Flat Washers 1/4", (Fig 48). Do not tighten the Button Head Screws.

Fig 47

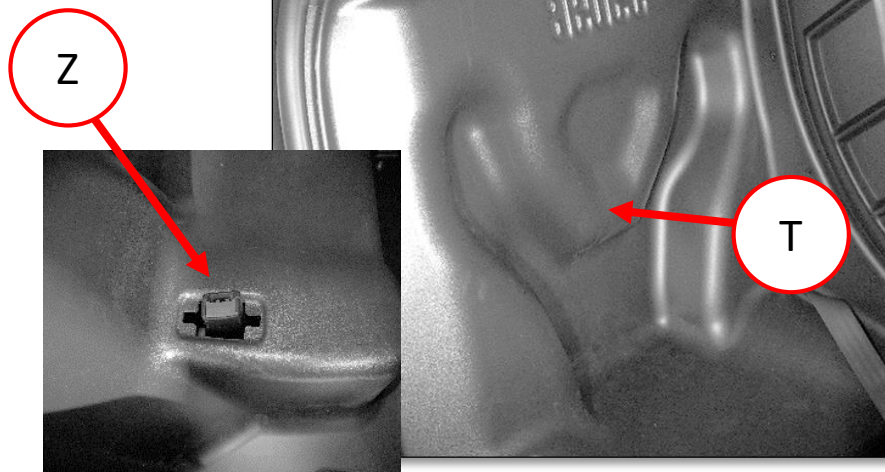
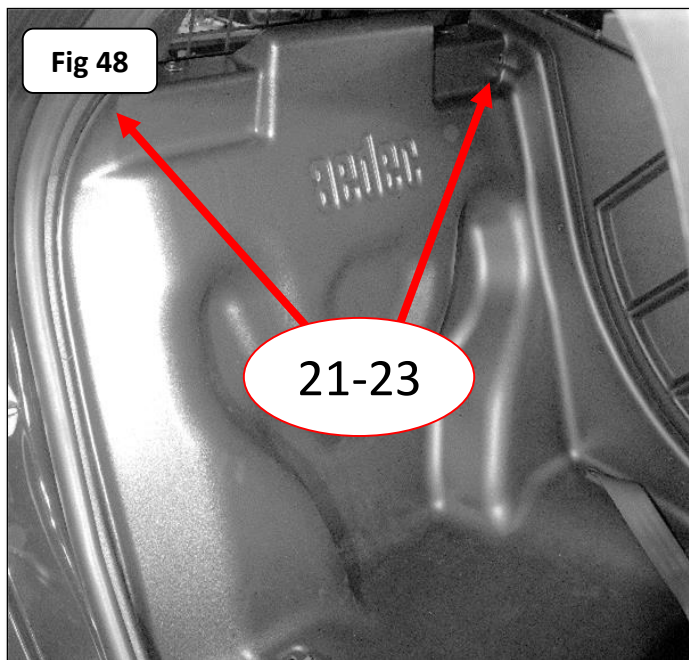
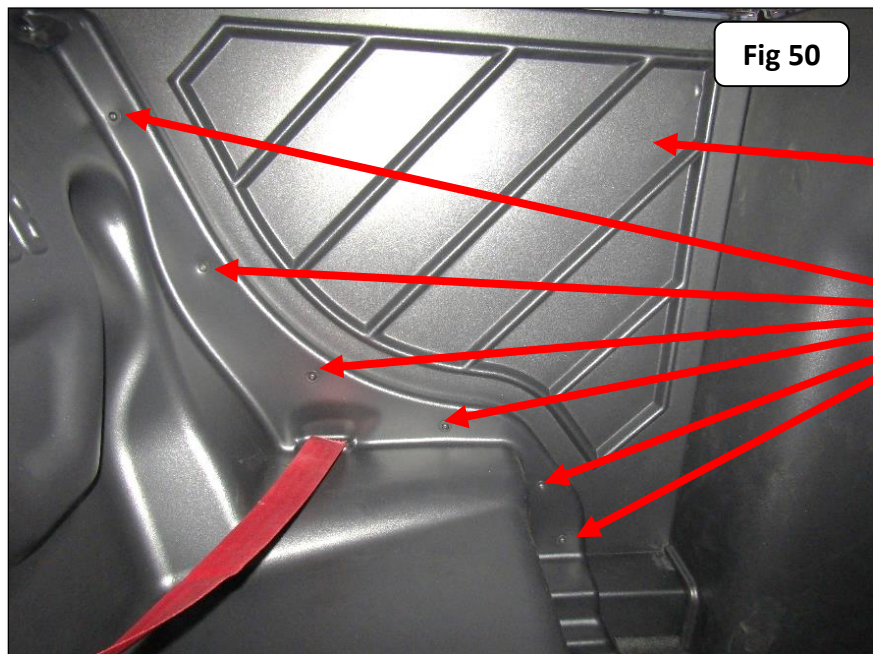
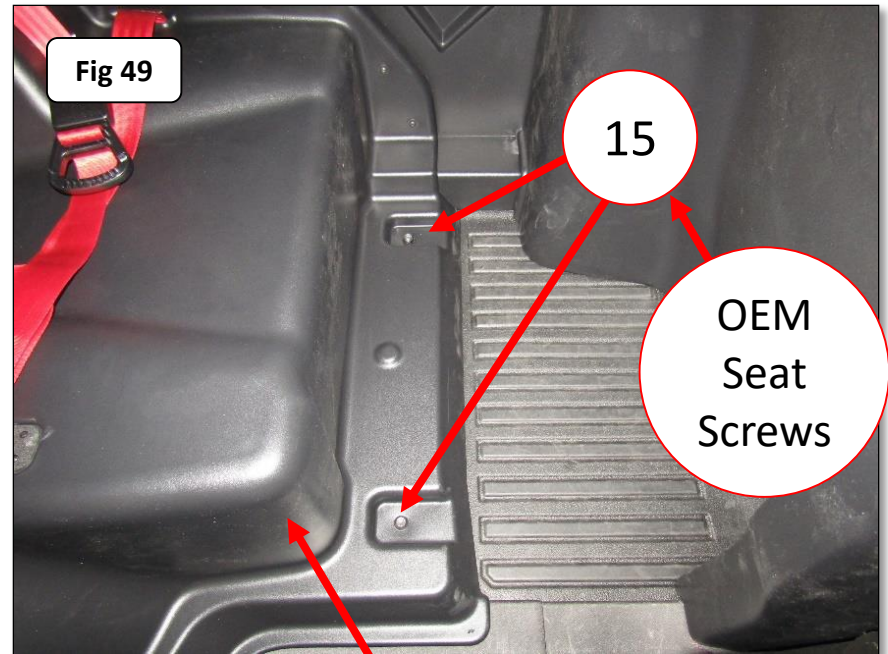

Fig 48



Step-41 Single Cell Seat to Single Cell Center Lower Panel. Insert (6) Button Head Hex Drive Screws, 1/4"-20 X 3/4", (12) Flat Washers 1/4" and (6) Nylon-Insert Locknut, 1/4"-20" through the Single Cell Seat and Single Cell Center Lower Panel, (Fig 49). Finger tighten only. Note: Feed bolts and washer from the Single Cell Seat side. One washer will be on the bolt side and one washer will be on the nut side.

Step-42 Align the (2) holes in the base of the single Cell Seat with the threaded inserts in the floor of the vehicle and attach the Seat to the floor of the vehicle using (2) OEM Seat Screws and (2) Flat Washers M10, (Fig 50). Ensure the distance from the front bottom flange of the seat and the jog of the door is 2-7/16" +/- 1/16. Do not tighten the OEM Seat Screws.



Step-43 Loosen the nuts and screws on each side of the Rear Window Assembly. Align the slots with the screws and slide Upper Filler Panels into position between the Rear Window Assembly frame and the polycarbonate window panel then retighten the nuts and screws, (Fig 51).

Note: Make sure to peel off and/or remove the protective film from the Upper Filler Panels before installing.

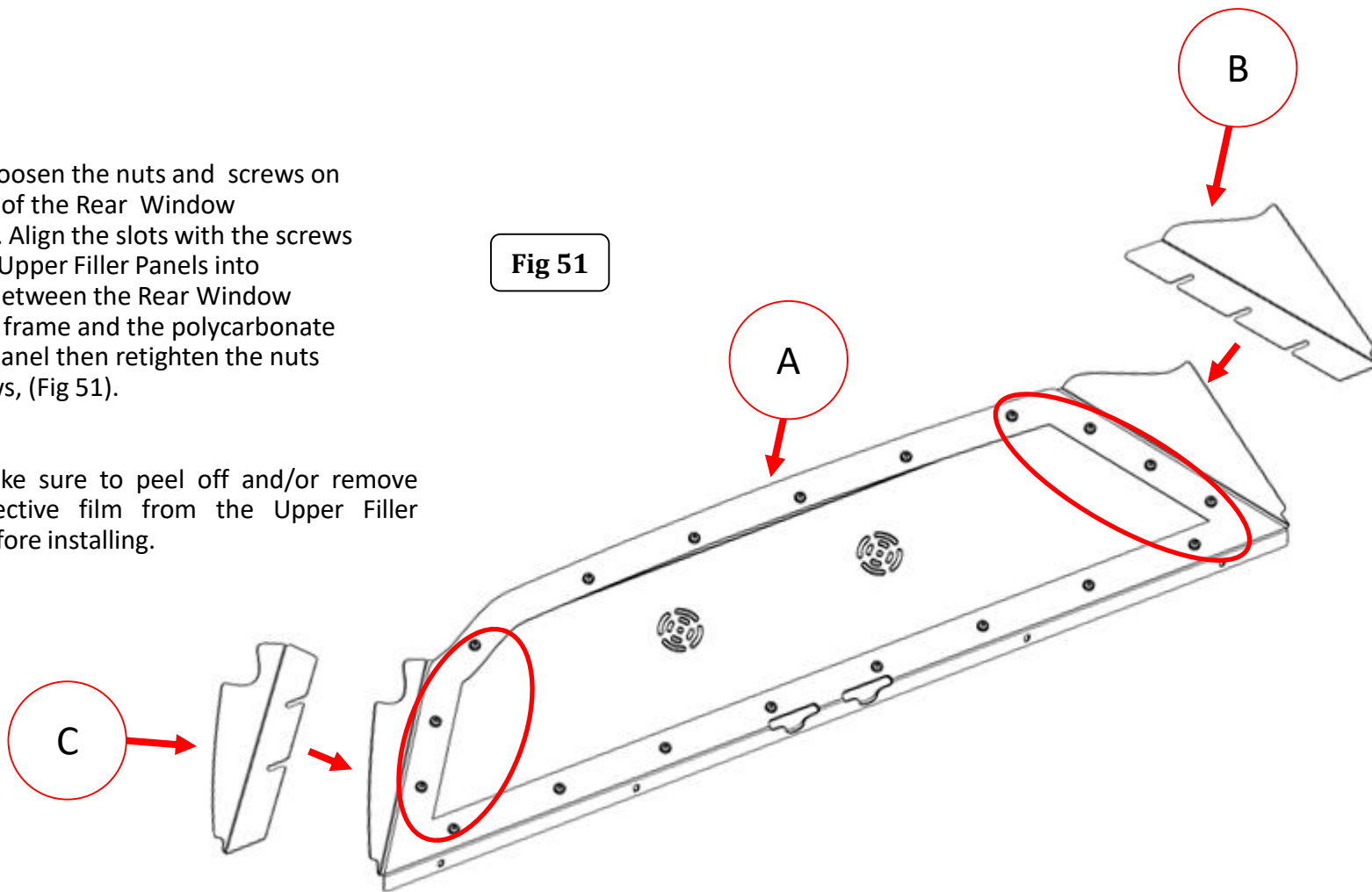

Step-44 With assistance, from the rear passenger area of the vehicle, position the Rear Window Assembly on the top of the Single Cell Seat and Rear Crossbar. Align the (4) holes in the Rear Window Assembly frame, with the holes in the Single Cell Seat and the rivet-nuts in the Rear Crossbar. Attach the Rear Window Assembly frame to the Rear Crossbar main tube using (4) Hex Head Screws 1/4"-20 x 1 1/4", (4) Lock Washers 1/4" and (4) Flat Washers 1/4", {Fig 52}. Tighten all nuts and screws.

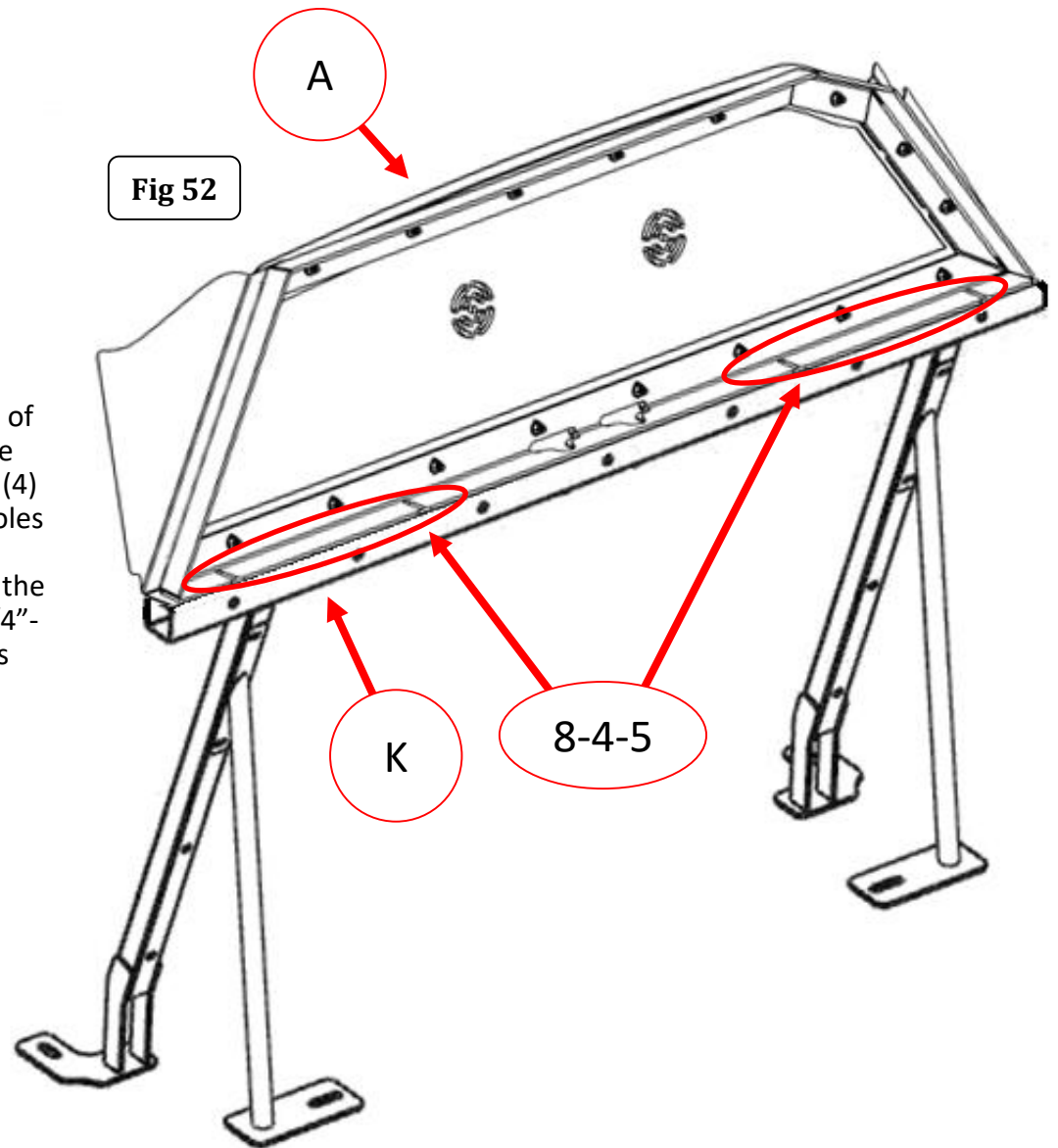

Step-45 Attach the Buckle Trim Plate to the Single Cell Seat using (4) Phillips Rounded Head Number 6 1/2" screws, (Fig 53).

Step-46 This step will require two people. Remove the screw, washers and hex nut in the middle of the Rear Screen Window Assembly, (Fig 54). Use the screw, washers and nut to mount the Center Panel Bracket to the Rear Screen Window Assembly.

Step-47 Attach the Center Upper Panel to the Center Panel Bracket using (1) Button Head Hex Drive Screw 1/4"-20 x 1", (2) Flat Washer 1/4" and (1) Nylon-Insert Locknut 1/4"-20", (Fig 55). Finger tighten. NOTE: Insert the Button Head Hex Drive Screw so the head of the fastener is the Single Cell compartment. Tighten Securely.

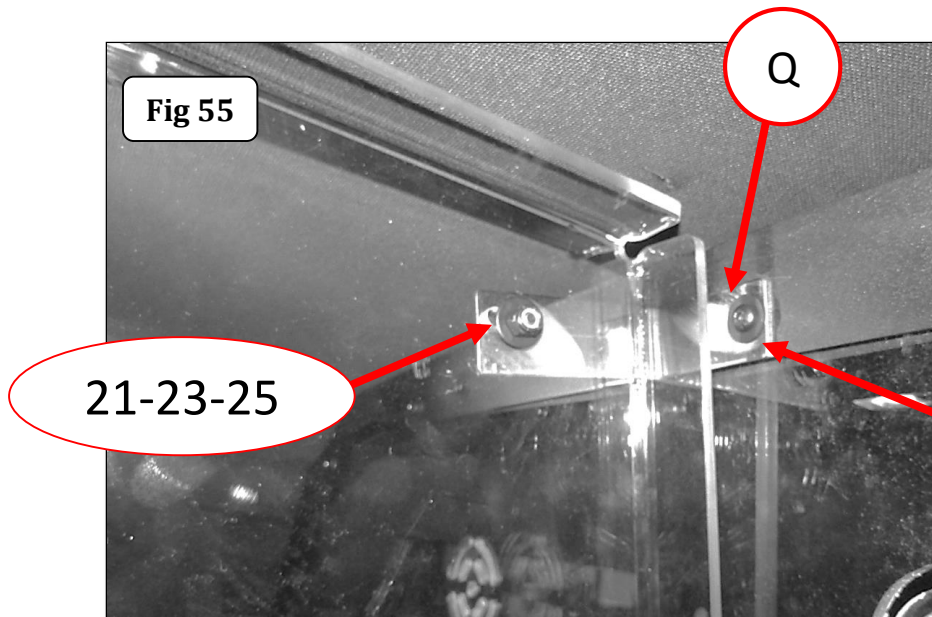
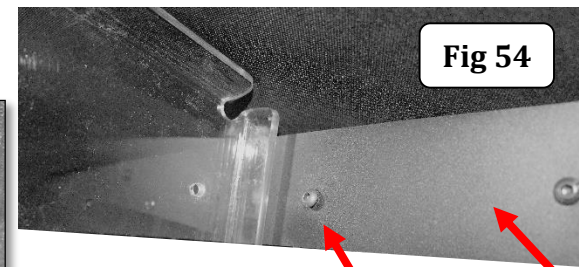
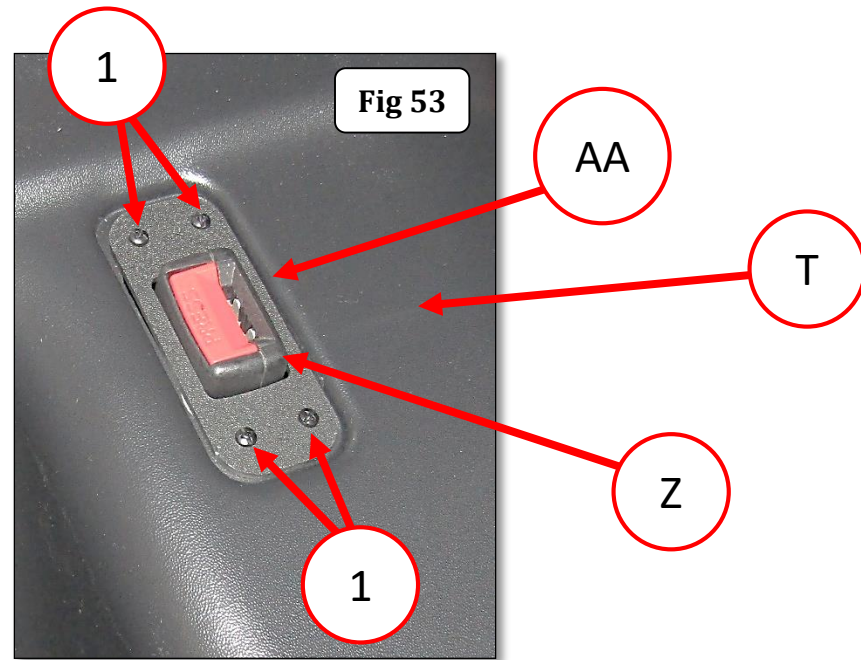

Step-48 Vent Cover. Insert (4) Button Head Hex Drive Screws, 1/4"-20 X 1" through the four holes around the slotted vents in the Center Upper Panel and fasten with (4) Hex Nut 1/4"-20, (Fig 56). Securely Tighten. Align the holes and position the Vent Cover over the (4) Button Head Hex Drive Screws, and fasten with (4) Nylon-Insert Locknut, 1/4"-20", (Fig 57). Tighten securely.

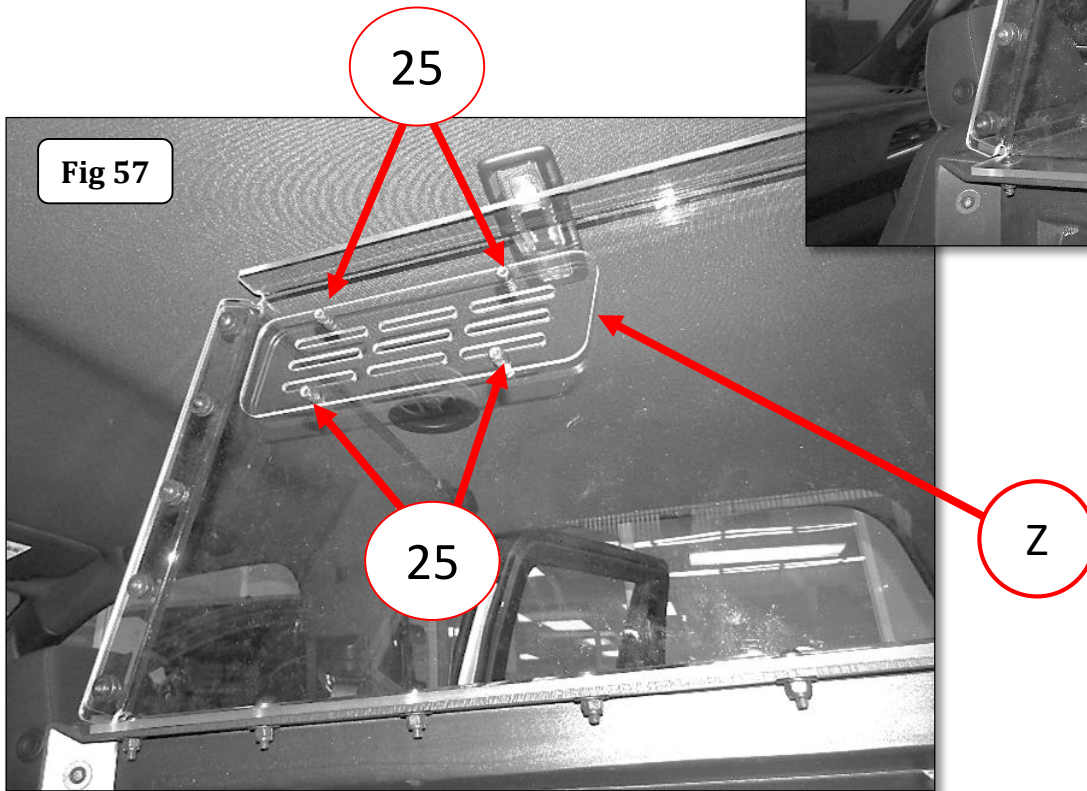
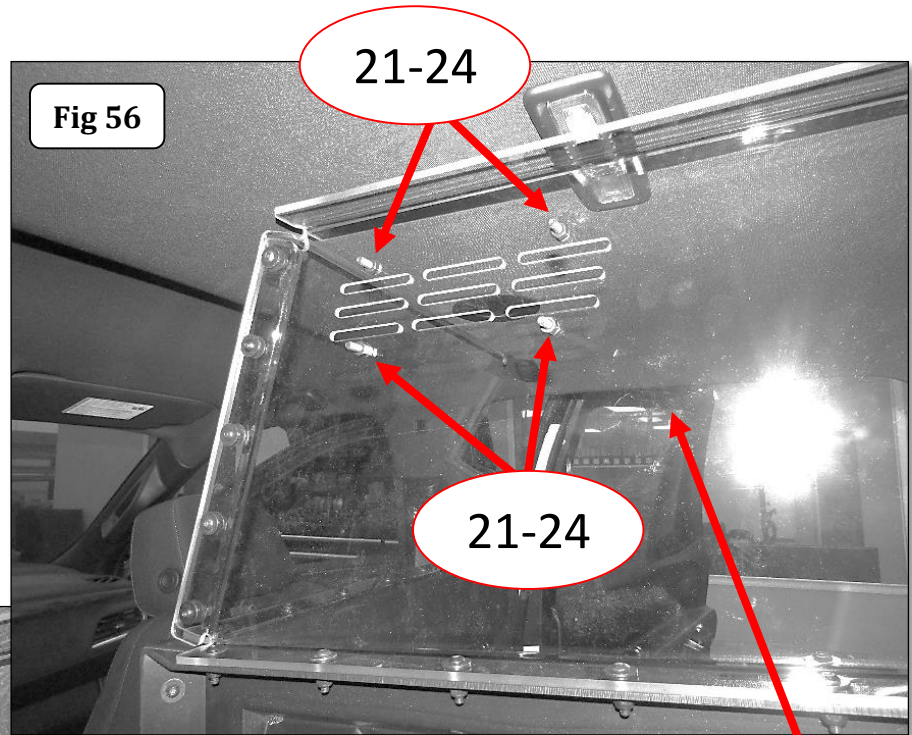

Step-49 Ensure the belts of the 3- Point Belt are not twisted, then install (1) Shoulder Screw 3/8" through the shoulder belt (yellow) anchor plate of the 3-Point Belt and secure to the threaded insert in the Rear Crossbar, {Fig 58 & 59}. Tighten the Shoulder Screw.

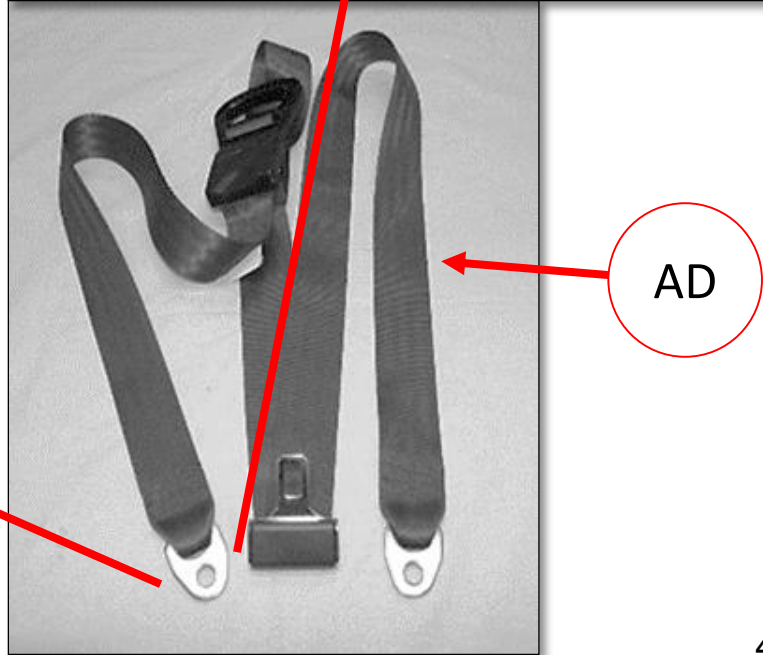
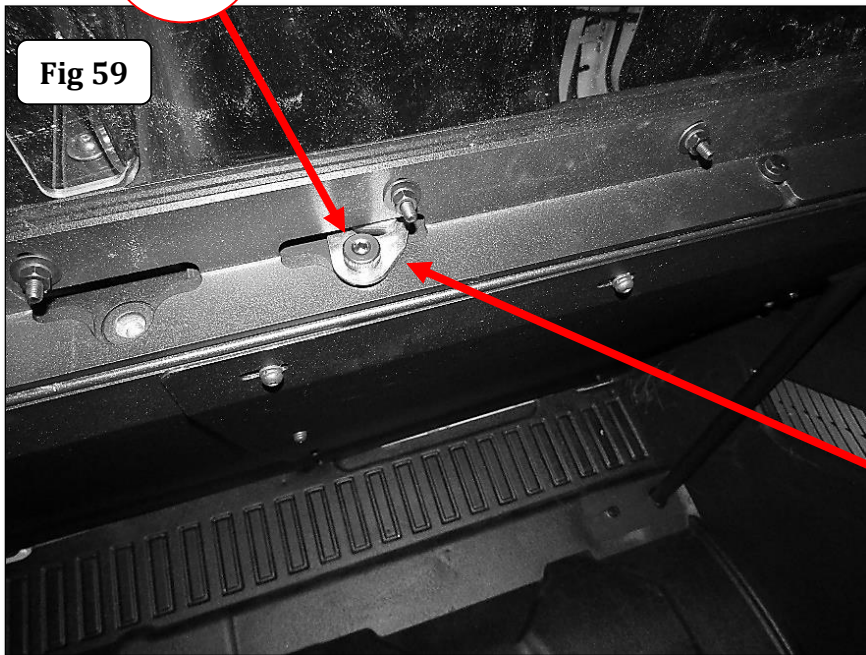
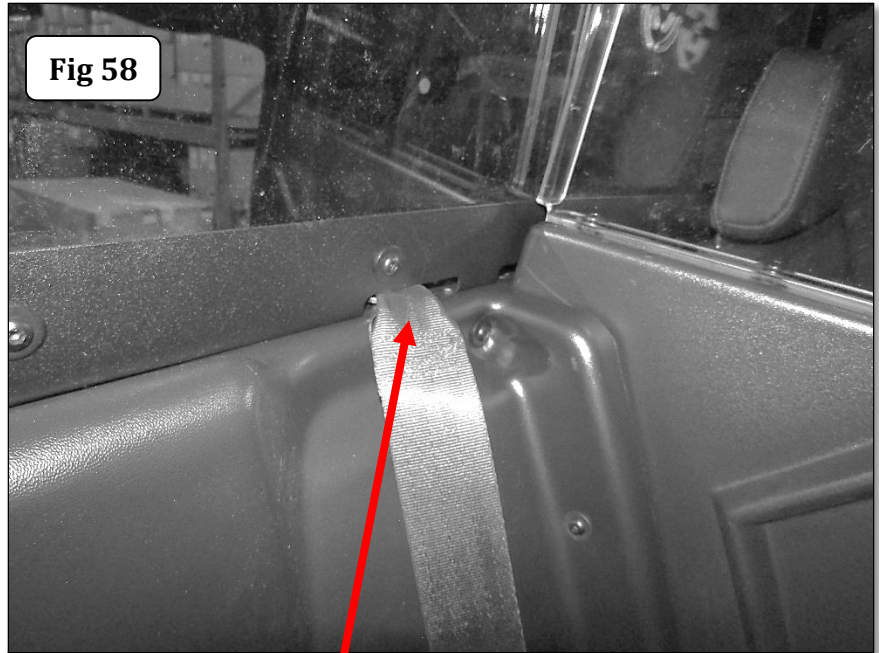

Step-50 Tumble the rear seat section forward. Attach the Waist Buckle to the inboard Seat Adapter Bracket Using (1) Hex Head Cap Screw 1/2"-13 x 2", (1) Flat Washer 1/2" through the hole in the seat adapter bracket and the waist buckle anchor plate. Fasten using (1) Flat Washer 1/2" and (1) Nylon-Insert Locknut, 1/2"-13, (Fig 60 & 61). Return the rear set section to the seating position. Pull the factory shoulder strap across the front of the seat. Line up the shoulder belt latch on the shoulder belt webbing with the slot in the top of the waist buckle and insert it fully. You should hear a click when the buckle fully engages and locks onto the shoulder belt latch. Let the shoulder belt retract, then fully tighten the nut and bolt securing the Waist Buckle.

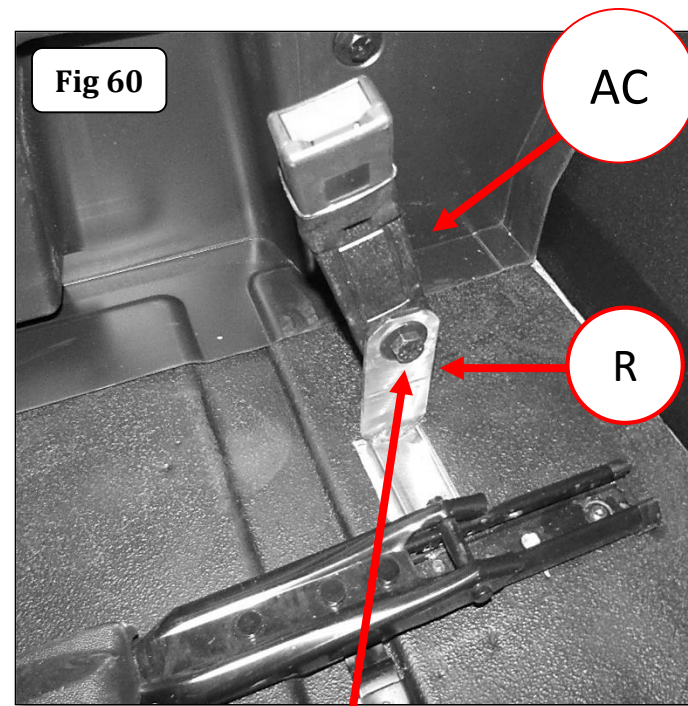

Fig 61

OEM
Shoulder
Belt

AC

27-29

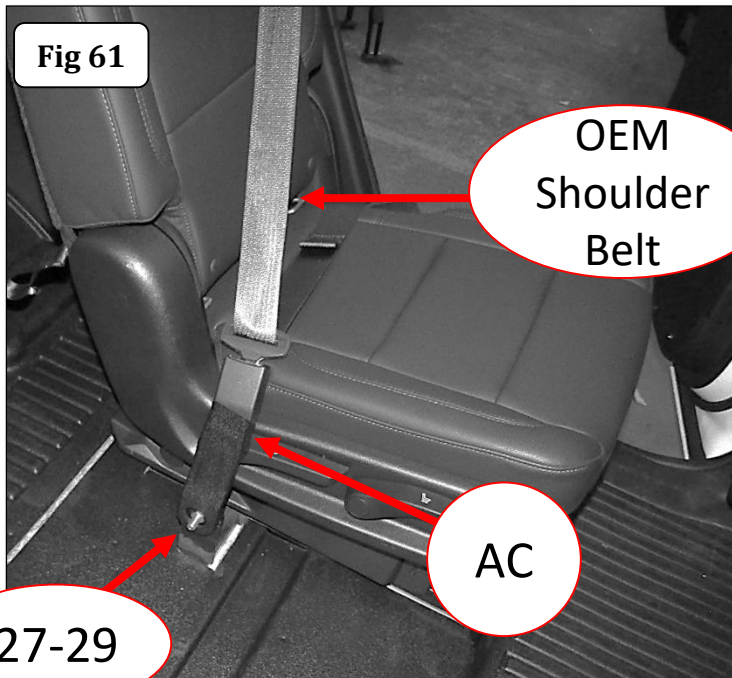
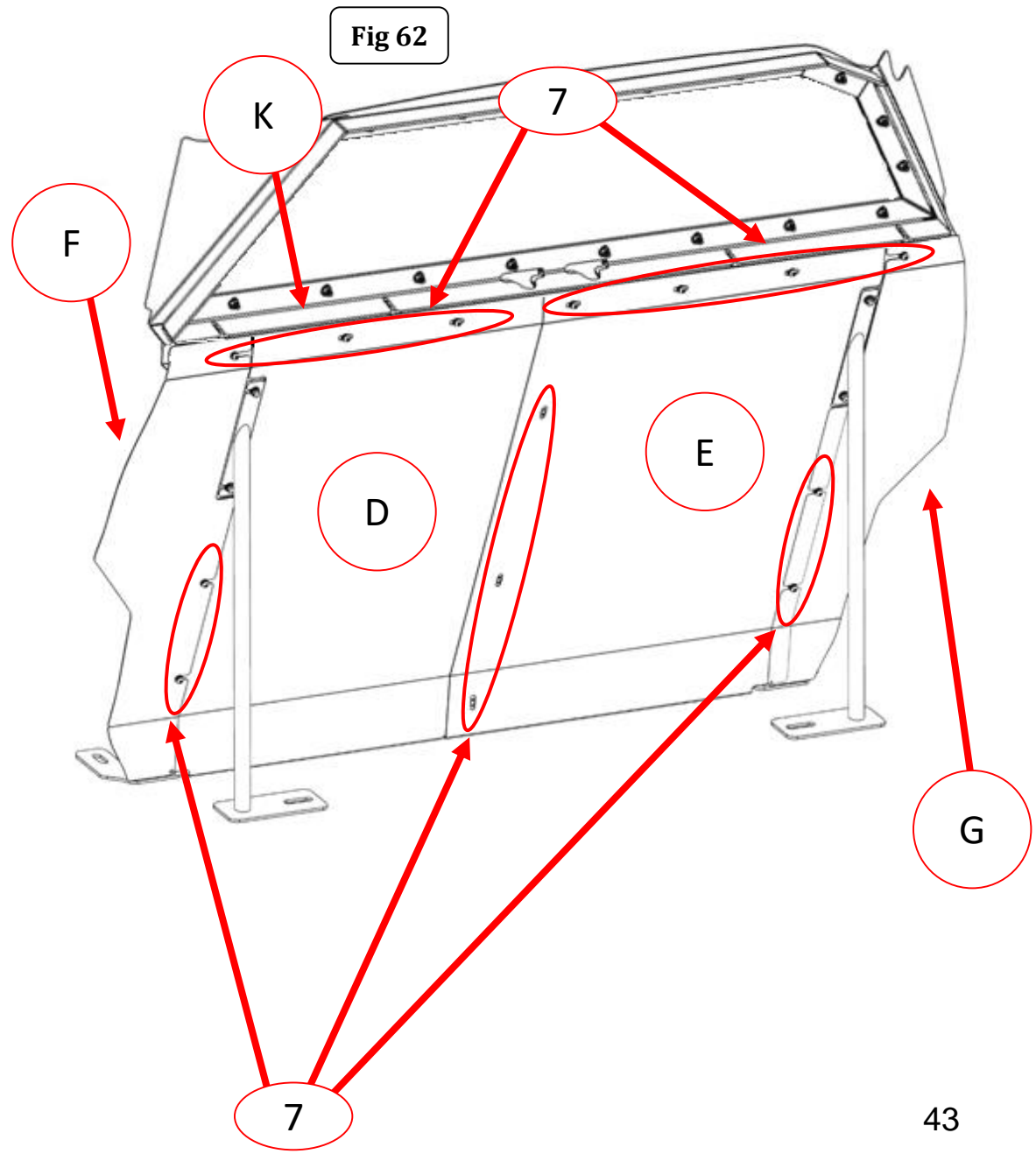

Fig 62

Step-51 Align the holes in the top of Center Closeout Panel (Left Side) with the rivet-nuts installed in the crossbar main tube and attach the Closeout Panel to the Rear Crossbar main tube using (2) SEMS Button Head Hex Drive Screw 1/4"-20 x 3/4", (Fig 62). Do not tighten the screws.

Step-52 Align the holes in the top of the Center Closeout Panel (Right Side) with the rivet-nuts installed in the Rear Crossbar main tube and attach the Closeout Panel to the Rear Crossbar main tube using (3) SEMS Button Head Hex Drive Screw 1/4"-20 x 3/4", then attach the Center Closeout panel (Right Side) to the rivet-nuts in the Center Closeout Panel (Left Side) to using (3) SEMS Button Head Hex Drive Screw 1/4"-20 x 3/4", (Fig 62). Do not tighten the screws.

Step-53 Align the holes in the Closeout panel (Left Side) with the rivet-nuts installed in the in the Rear Crossbar main tube and vertical tube. Attach the Closeout Panel to the Rear Crossbar main tube and vertical tube using (3) SEMS Button Head Hex Drive Screw 1/4"-20 x 3/4", (Fig 62). Repeat for the Closeout Panel (Right Side). Tighten all screws.



Step-54 Measure and mark the Buckle and Buckle Spacer attachment location on the side of the Partition Front Lower Panel, (Fig 63). Using a 5/16" drill bit, drill (2) holes through the Front Lower Panel at the marked locations.

Step-55 Attach (1) Buckle and Buckle Spacer to the Front Lower Panel using (2) Button Head Hex Drive Screw, 1/4"-20 X 1 1/4", (2) Flat Washer 1/4" and (2) Nylon-Insert Locknut, 1/4"-20, (Fig 64). Tighten the nuts and screws.

Fig 63

Drill (2) 5/16" Holes



Fig 64

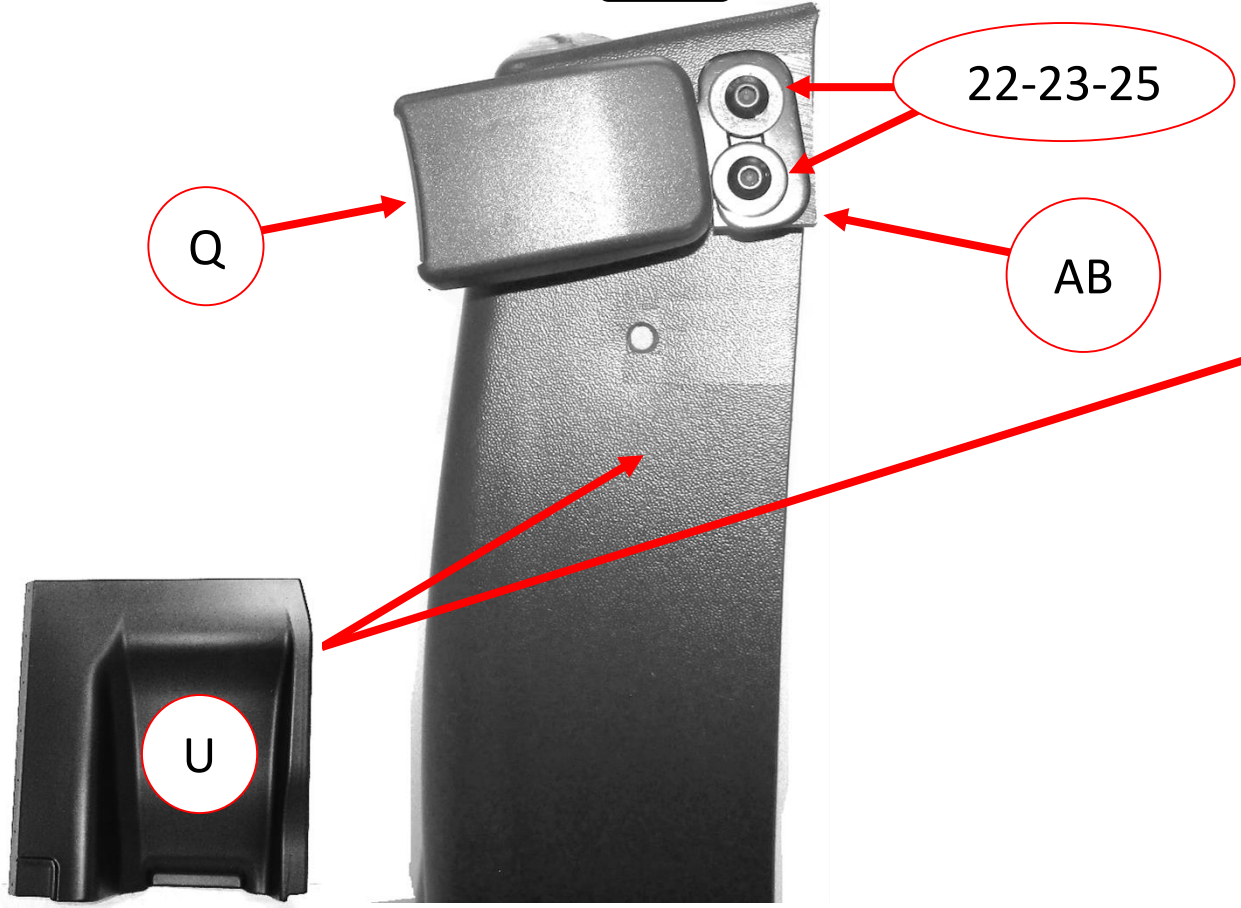

Step 56 Insert the 3 Point Belt into Buckle attached to the Lower Front Panel, (Fig 65). Ensure all fasteners are securely tightened and cover all exposed nylon lock nuts with the supplied Plastic Nut Caps.





INSTALLATION INSTRUCTIONS

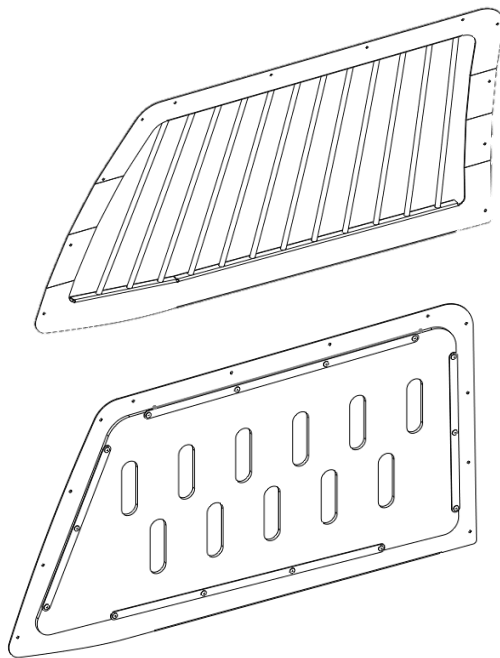

PART NO.

- 571343
- 571344

PRODUCT DESCRIPTION:

VERTICAL BARS WINDOW GUARDS
 POLYCARBONATE WINDOW GUARDS

APPLICATION:

- TAHOE PPV (Non civilian model)

PRODUCT SAFETY & LEGAL DISCLAIMER

- **IMPORTANT READ ALL INSTRUCTIONS CAREFULLY BEFORE INSTALLING, FAILURE TO DO SO MAY CAUSE PERSONAL INJURY OR DAMAGE TO PRODUCT AND/OR PROPERTY.**
- **Review the product package and contents prior to beginning the installation.** Take care when opening the packaging and removing items. If a return is needed you will want to return the product in its original packaging if possible.
- This instruction guide is provided as a GENERAL installation guide, some vehicles vary dimensionally and may require additional steps.
- Test fit the product on the vehicle prior to any third party modifications and or finishing. The manufacturer and/or distributors do not accept responsibility for third party charges, labor and or third part replacement modifications. Some modifications may void the factory warranty.
- Exercise due-diligence when installing this product. The manufacturer and distributors of this product do not accept any responsibility for vehicle damage or personal injury resulting from the installation of this product. Careless installation and operation can result in serious injury or equipment damage.
- This product is for general off-road use. All liability for installation and use rests with the owner/operator.
- **INSTALLER:** Once installation is complete, please return this guide along with other documentation included in this product back to the consumer for future reference. The manufacturer/distributors of this product do not guarantee this particular version will be available at a later date.

© 2016 Go Rhino Products. All rights reserved

www.gorhino.com 589 W. Apollo St., Brea, CA 92821 P: 888 427 4466



INSTALLATION INSTRUCTIONS

INJURY HAZARD

Please complete a shop and tool inspection prior to beginning the installation.

- Always make sure you have a clean, dry and well lit work area.
- Always remove jewelry, loose fitting clothing and wear protective gloves and eye protection.
- Always use extreme caution when jacking or raising a vehicle for work. Set the emergency brake and use tire/wheel blocks and jack stands. Refer to the vehicle manufacturer hand book. Utilize the vehicle manufacturers designated lifting points.
- Always use appropriate and adequate care in lifting parts during disassembly and installation. Seek help in lifting heavy or large items into place. Utilize jacks and or lifting devices when available.
- Always insure products are secure during disassembly and installation.
- Always wear eye protection and take steps to protect any exposed skin during the installations. Drilling, cutting and grinding plastic and metal may create flying particles that can cause injury.
- Always use extreme caution when drilling, cutting and or grinding on a vehicle. Thoroughly inspect the area to be drilled, on both sides of material, prior to modification and relocate any objects that may become damaged.
- Always assemble and tighten all fasteners per the installation instructions.
- Always route electrical cables carefully. Avoid moving parts, parts that may become hot and rough or sharp edges.
- Always insulate and protect all exposed wiring and electrical connections.

MAINTENANCE AND CARE

- Always perform regular inspections and maintenance on mounts and related fasteners.
- Periodically check and tighten all fasteners.
- Stripped, fractured, or bent fasteners must be replaced.
- After washing the vehicle make sure to fully dry all surfaces.
- In areas with cold temperatures make sure to wash the product often to remove harmful materials used on road ways.
- Never use abrasive cleaners or polish compounds. Clean with a gentle soap and water. If you use wax use a non-abrasive automotive wax such as pure carnauba wax.

WARNING

Some products have been designed to work together with factory rear sensor systems, factory forward facing sensor systems and factory air bags.

- Installation of some of these products may alter the factory sensor system performance.
- Factory sensors may read shackles or hooks protruding from the fairlead and or tow hooks.
- All sensor testing is completed by Go Rhino Products and or third party testing labs on modified vehicles.
- Sensor sensitivity, factory sensor housing, orientation, and operating conditions are all variables that will influence functionality of the sensors.
- Installation of some product may effect the factory air bag systems.
- Some products allow the use of third party products such as winches, shackles, hooks, etc. Follow the respective manufacturers operating instructions for use with our products.
- Make sure to fully understand the product, it's intended use and operation prior to use.
- Above all... be safe!

GO RHINO®

INSTALLATION INSTRUCTIONS

PARTS INCLUDED IN THIS LIST:

ITEM	QTY.	PART NUMBER	DESCRIPTION	ITEM	QTY.	PART NUMBER	DESCRIPTION
A	24		#8 x 3/4" Self Drilling Screw				
B	1		Window Guard (driver)				
C	1		Window Guard (passenger)				

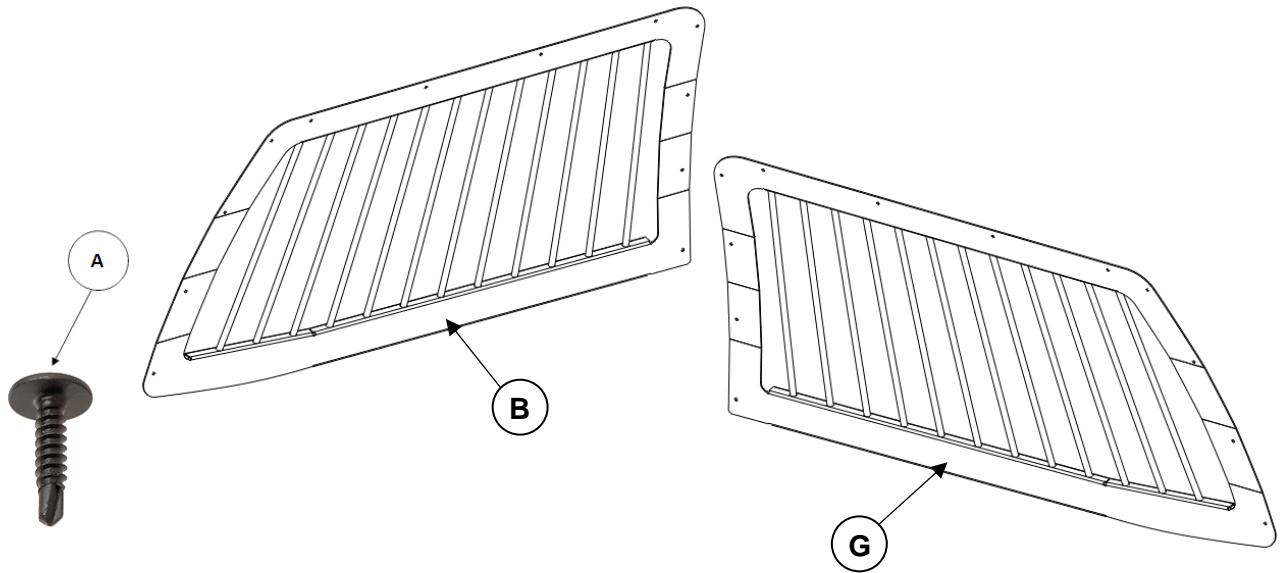

Go Rhino recommends you, the installer, read this installation instruction manual from front to back before installing the product. You may also [click here](#) to view an installation video or visit <http://www.gorhino.com/Installation-Videos>.

TOOLS NEEDED FOR INSTALLATION:

- #2 Phillips driver bit
- Drill motor

ESTIMATED TIME FOR INSTALLATION:

1 Hour

If you need installation service for your new product, call the authorized distributor from whom you purchased the product or an authorized installation service company which can be found by calling toll free 1-888-427-4466

GO RHINO®

INSTALLATION INSTRUCTIONS

Step-1 Beginning with the driver side, open the rear door and roll down the rear window.

Step-2 Position the bottom of the driver side window guard frame so it is resting on top of the door trim panel and the right side outer edge of the frame is flush with the door window frame molding.

Step-3 With the window guard in place, install the (11) #8 X 3/4" self-drilling screws starting at the bottom on each side first, and then work up each side to install the remaining screws. Repeat steps to install the passenger side window guard.





INSTALLATION INSTRUCTIONS

LIMITED WARRANTY

Go Rhino warrants to Buyer that for a period of five (5) years from the date of shipment of the product(s) ("Warranty Period") for black finishes and chrome finishes, that such products will materially conform to the specifications set forth in Go Rhino's specifications in effect as of the date of shipment(s) and will be free from material defects in material workmanship.

Go Rhino warrants to Buyer that for the life of the product(s) from the date of shipment of the product(s) ("Warranty Period") for polished stainless steel finished products purchased after April 2004, that such products will materially conform to the specifications set forth in Go Rhino's specifications in effect as of the date of shipments and will be free from material defects in material workmanship.

Warranty claims must be accompanied with the original invoice and photos of the product. It is the customer's responsibility to clean regularly and protect finish with regular applications of a nonabrasive polish that is compatible with the product's finish.

This warranty covers the cost of the product only and does not include the cost of removal, installation, third party modifications or shipping of the product. In no event shall Go Rhino be liable to buyer or any third party for any damage or harm caused by the product or use thereof, regardless of weather such damages were foreseeable and whether or not Go Rhino has been advised of the possibility of such damages, not withstanding the failure of any agreed or other remedy of its essential purpose. This warranty is void if the product shows signs of alteration, misuse, mishandling, improper care, neglect, improper application and/or damage due to improper installation.

With respect to any such product(s) during the limited warranty period, Go Rhino shall, in its sole discretion, either: (i) provide a one-time repair or replacement of such products (or the defective part) or (ii) credit or refund the price of such products at the pro rata contract rate provided that, if Go Rhino so requests, Buyer shall, at Go Rhino's expense, return such product(s) to Go Rhino. The remedies shall be the Buyer's sole and exclusive remedy and Go Rhino's entire liability for any breach of the limited warrant(ies).

Go Rhino disclaims all other warranties except to the extent that any such warranty cannot be validly disclaimed under applicable law.

Finish Limited Warranty:

Limited lifetime on stainless steel products (after April 2004)

5 year warranty on black powder coat products

5 year warranty on chrome products

This warranty does not cover exposed welds

Finish warranty covers peeling, flaking, or cracking. Washing all finishes regularly with car wash soap and rinsing well with water is the best method for maintaining the finish on your products. You must also protect the finish with nonabrasive automotive wax on a regular basis. The use of any compound which contains abrasives becomes a self-defeating exercise as the compound scratches the finish and opens it to corrosion. The use of harsh chemicals used to remove bugs and tar may also cause the finish to fail and should be avoided.

If you are unsatisfied with your purchase please contact the establishment you purchased the product from.

If you need to place a warranty claim or need assistance, the Go Rhino customer service team will answer any questions you may have. Please contact the Go Rhino customer service team at 1-888-427-4466 during normal business hours Monday thru Friday 7 am to 5 pm PST. You may also email warranty@gorhino.com. In order to better serve you please provide a copy of the original invoice / receipt, a photo of the issue you are experiencing and a photo of the vehicle the product is installed on.

All warranty returns must have an approved RGA number. The RGA number must be clearly marked on the exterior of the return package. All approved warranty returns must be shipped to Go Rhino Products, 1002 Carriers Drive, Laredo, Texas 78045.

PRODUCT REGISTRATION

Please remember to register your new purchase. You may register your product at www.gorhino.com. Registering your product may help speed any future warranty or customer service inquiries.

Thank you again for purchasing from Go Rhino Products

Please take a few minutes to view additional products for your vehicle and more at GORHINO.com
These installation instructions are available on the Go Rhino web site along with installation videos for many of our products.

www.gorhino.com

www.bigcountryauto.com

www.gorhinopd.com