



## **INSTALLATION INSTRUCTIONS**



**2009-13 FORD F150 4WD**  
**4" BASIC & PERFORMANCE SYSTEMS**  
**FTS22156 - BASIC w/ REAR PERFORMANCE SHOCKS**  
**FTS22157 - PERFORMANCE w/ DIRT LOGIC SHOCKS**  
**FTS22206 - 2014 PERFORMANCE w/DIRT LOGIC SHOCKS**

Fabtech Motorsports | 4331 Eucalyptus Ave. Chino, CA 91710

Tech Line: 909-597-7800 | Fax: 909-597-7185 | Web: [www.fabtechmotorsports.com](http://www.fabtechmotorsports.com)

## - PARTS LIST -

	<b>FTS22155</b>	<b>COMPONENT BOX 1</b>
1	FT30489BK	FRONT CROSSMEMBER 4" 4WD
1	FT30512BK	REAR CROSSMEMBER 4" 4WD
1	FT30492	SWAY BAR DROP BRACKET DRIV
1	FT30493	SWAY BAR DROP BRACKET PASS
1	FT30377BK	SKID PLATE
2	FT30491	DIFF DROP BRKT UPPER
1	FT30567	DIFF DROP BRKT CENTER
1	FT30585BK	DIFF DROP BRKT REAR
1	FT30566	HARDWARE KIT

	<b>FTS22206</b>	<b>COMPONENT BOX 2 - (2014)</b>
1	FTS30494D	SPINDLE MACHINED DRVR
1	FTS30494P	SPINDLE MACHINED PASS
4	FT350U	UBOLT SQ 9/16-18X10.50X3.00
2	FTBK22	BLOCK 2.25" W/ 2 PIN
1	FT30504	HARDWARE KIT
1	FT30505	HARDWARE SUBASSEMBLY
1	FT295	ALIGNMENT CAM HALF KIT 09 F150
2	FTS30503	2014 COILOVER 4"

	<b>FTS22156</b>	<b>COMPONENT BOX 2 - BASIC</b>
2	FTS30502	F150 4WD 4IN STRUT (09-13)
1	FTS30494D	SPINDLE MACHINED DRVR
1	FTS30494P	SPINDLE MACHINED PASS
4	FT350U	UBOLT SQ 9/16-18X10.50X3.00
2	FTBK22	BLOCK 2.25" W/ 2 PIN
1	FT30504	HARDWARE KIT
1	FT30505	HARDWARE SUBASSEMBLY
1	FT295	ALIGNMENT CAM HALF KIT 09 F150

	<b>FT30505</b>	<b>HARDWARE SUBASSEMBLY</b>
2	FT30496	FRONT BRAKE LINE BRACKET
1	FT70033	REAR BRAKE LINE BRACKET
1	FTREGCARD	REGISTRATION CARD
1	FTAS16	DRIVER WARNING DECAL
1	FTAS12	STICKER FT BLUE 10X4 DIE CUT
1	FT22156i	INSTRUCTIONS
4	FT1020	BUSHING
2	FT181	SLEEVE

	<b>FTS22157</b>	<b>COMPONENT BOX 2 - PERFORMANCE</b>
1	FTS30494D	SPINDLE MACHINED DRVR
1	FTS30494P	SPINDLE MACHINED PASS
4	FT350U	UBOLT SQ 9/16-18X10.50X3.00
2	FTBK22	BLOCK 2.25" W/ 2 PIN
1	FT30504	HARDWARE KIT
1	FT30505	HARDWARE SUBASSEMBLY
1	FT295	ALIGNMENT CAM HALF KIT 09 F150

	<b>FT295</b>	<b>ALIGNMENT CAM HALF KIT 09 F150</b>
4	50000005652	WASHER FLAT M18 ZINC
4	50180004382	LOCKNUT M18-2.5 CL8 ZINC
8	FT292-1	ALIGNMENT CAM 04 FORD F150 4WD
2	FT292-2	ALIGNMNT BOLT 150MM LONG
2	FT295-1	ALIGNMNT BOLT 180MM LONG

	<b>FT30566 - HARDWARE KIT</b>	<b>LOCATION</b>
1	1/2-13 X 2-3/4 HEX BOLT G8 ZNC	DIFF MOUNT
1	1/2-13 X 2 HEX BOLT G8 ZINC	DIFF MOUNT
4	1/2 SAE WASHER G8 ZINC	DIFF MOUNT
2	1/2-13 C-LOCK NUT ZINC	DIFF MOUNT
3	M10-1.5 X 45MM HEX BOLT G10.9	DIFF MOUNT
3	10MM SPLIT WASHER	DIFF MOUNT
3	M10 FLAT WASHER ZINC	DIFF MOUNT
1	5/16-18 X 2-3/4 SHCS	DIFF MOUNT
1	5/16 SAE WASHER G5 ZINC	DIFF MOUNT
1	5/16-18 C-LOCK NUT ZINC	DIFF MOUNT
6	7/16-14 C-LOCK NUT ZINC	SHOCK EXT
6	7/16 SAE WASHER G5 ZINC	SHOCK EXT

	<b>FT30504 - HARDWARE KIT</b>	<b>LOCATION</b>
4	1/2-13 X 4 HEX BOLT G8 ZINC	DIFF
8	1/2 SAE WASHER G8 ZINC	
4	1/2-13 C-LOCK NUT ZINC	
3	1/2-13 X 1 HEX BOLT G8 ZINC	SKID PLATE
6	1/2 SAE WASHER G8 ZINC	
3	1/2-13 C-LOCK NUT ZINC	
4	3/8-16 X 1-1/4 HEX BOLT G8 ZNC	SWAY BAR
8	3/8 SAE WASHER G8 ZINC	
4	3/8-16 C-LOCK NUT ZINC	
1	1/2"-13 X 3-1/2" HEX BLT G8ZC	REAR DIFF SUPPORT
2	1/2" SAE WASHER G8 ZINC	
1	1/2"-13 C-LOCK NUT ZINC	
2	5/16-18 X 1 HEX BOLT G8 ZINC	FRONT BRAKE LINE DROP
4	5/16 SAE WASHER G8 ZINC	
2	5/16"-18 C-LOCK NUT ZINC	
6	7/16 SAE WASHER G8 ZINC	SHOCK SPACER
6	7/16-14 C-LOCK NUT ZINC	
1	1/4-20 X 1 HEX BOLT G8 ZINC	REAR E-BRAKE BRACKET
2	1/4" SAE WASHER G8 ZINC	
1	1/4"-20 C-LOCK NUT ZINC	
1	1/2-13 X 1-1/4 HEX BOLT G8 ZNC	
2	1/2 SAE WASHER G8 ZINC	
1	1/2-13 C-LOCK NUT ZINC	
1	5/16-18 X 1 HEX BOLT G8 ZINC	REAR BRAKE LINE BRACKET
2	5/16 SAE WASHER G8 ZINC	
1	5/16"-18 C-LOCK NUT ZINC	
8	9/16 SAE WASHER G5 ZINC	U-BOLT HARDWARE
8	9/16-18 NYLOCK NUT G5 ZINC	
1	THREAD LOCKING COMPOUND 1 MIL	
2	ZIP TIE 8" BLACK 40 LBS	
4	1/2-13 X 3" HEX BOLT	LOWER SHOCK MOUNT
8	1/2 SAE WASHER	
4	1/2-13 C-LOCK NUT	

## - PRE-INSTALLATION NOTES -

**For technical assistance call: 909-597-7800 or e-mail: info@fabtechmotorsports.com**

### *Read this before you begin installation-*

- Check all parts to the parts list above before beginning installation. If any parts are missing contact Fabtech at 909-597-7800 and a replacement part will be sent to you immediately.
- Read all instructions thoroughly from start to finish before beginning the installation. If these instructions are not properly followed severe frame, driveline and / or suspension damage may occur.
- Check your local city and state laws prior to the installation of this system for legality. Do not install if not legal in your area.
- Prior to the installation of this suspension system perform a front end alignment and record. Do not install this system if the vehicle alignment is not within factory specifications. Check for frame and suspension damage prior to installation.
- The installation of this suspension system should be performed by two professional mechanics.
- Use the provided thread locking compound on all hardware.
- Do not combine this suspension system with any other lift device or parts.
- This suspension must be installed with Fabtech shock absorbers.
- **WARNING-** Installation of this system will alter the center of gravity of the vehicle and may increase roll over as compared to stock.

### *Footnotes-*

- **Will not fit standard cab or Raptor models.**
- OEM Wheels and tires cannot be used after the installation of this kit. Larger tire cannot be installed on the OEM wheels.
- The Stock spare 18" tire & wheel can be used.
- Requires cutting of fender well sheet metal for use with 35" tires
- Vehicles that receive oversized tires should check ball joints, tie rods ends, pitman arm and idler arm every 2500-5000 miles for wear and replace as needed.

## **FACTORY FORD SPECIFICATIONS FOR 4 WHEEL DRIVE USE**

**NOTE: Do not use 4H or 4L mode on dry, hard surfaced roads. Doing so can produce excessive noise, increase tire wear and may damage drive components. 4H or 4L mode is only intended for consistently slippery or loose surfaces. Use of 4L mode on these surfaces may produce some noise (such as occasional clunks), but will not damage drive components.**

**4H (4X4 HIGH) - Used for extra traction such as in snow or icy roads or in off road situations. This mode is not intended for use on dry pavement.**

**4L (4X4 LOW) - Uses extra gearing to provide maximum power to all four wheels at reduced speeds. Intended only for off-road applications such as deep sand, steep grades, or pulling heavy objects. 4L (4x4 low) will not engage while your vehicle is moving above 3 mph; this is normal and should be no reason for concern.**

### *Recommend Tires and Wheels:*

- Use 295/70R18 tire w/ 18x9 wheels w/ 5" BS w/ fender trimming
- Use 35/12.50R18 tire w/ 18x9 wheels w/ 5" BS w/ fender cutting
- Use 295/60R20 tire w/ 20x9 wheels w/ 5" BS w/ fender trimming
- Use 35/12.50R20 tire w/ 20x9 wheels w/ 5" BS w/ fender cutting

## **- TOOL LIST -**

### **Required Tools (Not Included)**

Floor Jack, Jack Stands  
Assorted Metric and S.A.E sockets, and Allen wrenches  
Torque Wrench, Drill & Drill Bits, Spring Compressor

# - INSTRUCTIONS -

## FRONT SUSPENSION

1. Disconnect the negative terminal on the battery. Jack up the front end of the truck and support the frame rails with jack stands. **NEVER WORK UNDER AN UNSUPPORTED VEHICLE!** Remove the front tires.
2. Remove and discard the factory splash guard under the differential.
3. Locate the sway bar end links and disconnect from the factory lower control arms, save the hardware. Locate the sway bar frame mounts and disconnect them from the frame, remove the sway bar from the truck. Save the hardware and sway bar.
4. Working from the driver side of the vehicle, disconnect the tie rod ends from the steering knuckle by striking the knuckle to dislodge the tie rod end. **SEE FIGURE 1**



FIGURE 1 - STEP 4

5. Remove the brake caliper and place it next to the frame. Do not overstretch the brake hose when doing so. Retain the hardware for reinstallation. Remove the brake rotor and save. Disconnect the vacuum lines attached to the rear of the hub assembly. Allow the vacuum lines to hang freely. Remove the electronic stability control (ESC) sensor from the top of the hub. Cover the sensor to keep it free from dirt and debris.

6. Carefully remove the dust cap covering the hub assembly nut. Remove the C.V. bearing nut and save the nut and dust cap. **SEE FIGURE 2**

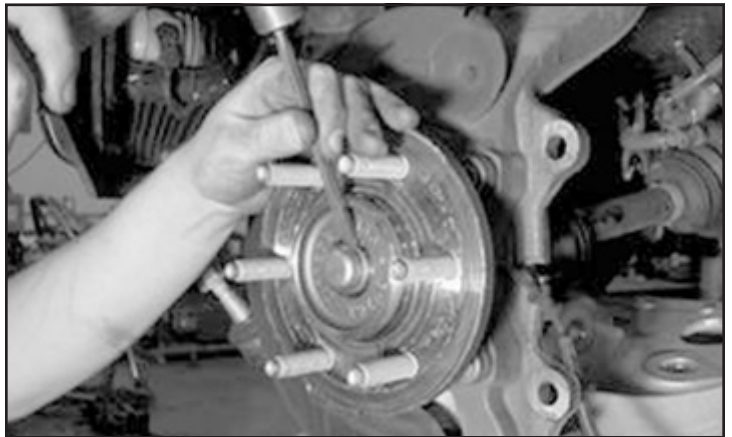


FIGURE 2 - STEP 6

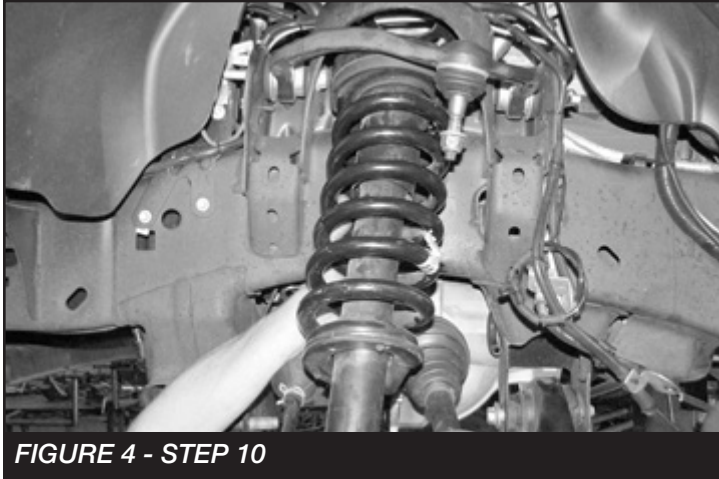
7. Remove the upper and lower ball joint nuts. Disconnect the upper and lower ball joints from the steering knuckle by striking the knuckle with a large hammer next to each ball joint on the knuckle to dislodge the ball joints. Use care not to hit the ball joints when removing. Retain hardware and remove the knuckle with the dust shield and the hub. Use extra care not to over extend the C.V. axle shaft when removing the knuckle. **SEE FIGURE 3**



FIGURE 3 - STEP 7

8. Remove the four large bolts and three small bolts on the back side of the knuckle. Remove the hub and the actuator from the knuckle. Save hardware for install in the Fabtech knuckle.
9. Remove the bolts on the front side holding the dust shield. Remove the dust shield and discard the factory knuckle.

10. Locate the lower shock mount bolt and remove. Save the hardware. Locate the three upper nuts and remove. Save the hardware. Remove the shock assembly from the vehicle and mark "Driver" for reassembly later with Fabtech shock. **SEE FIGURE 4**



**FIGURE 4 - STEP 10**

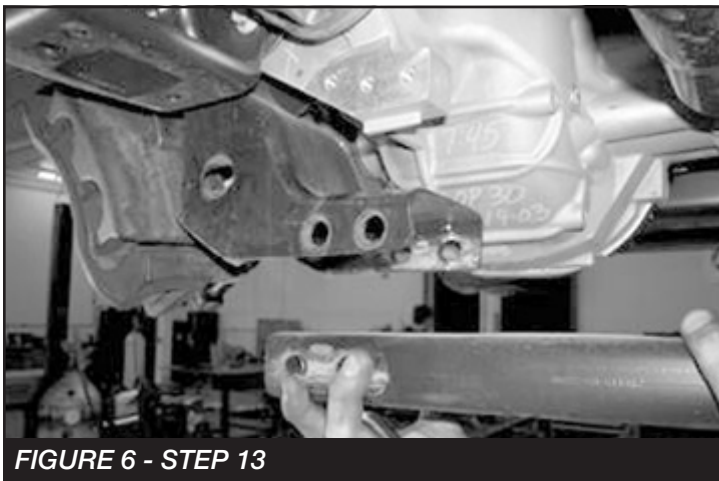
11. Remove the lower control arm bolts from the frame pivots and remove the lower control arm from the truck. Save hardware and lower control arm. **SEE FIGURE 5**



**FIGURE 5 - STEP 11**

12. Repeat steps 4 through 11 on the passenger side of the truck.

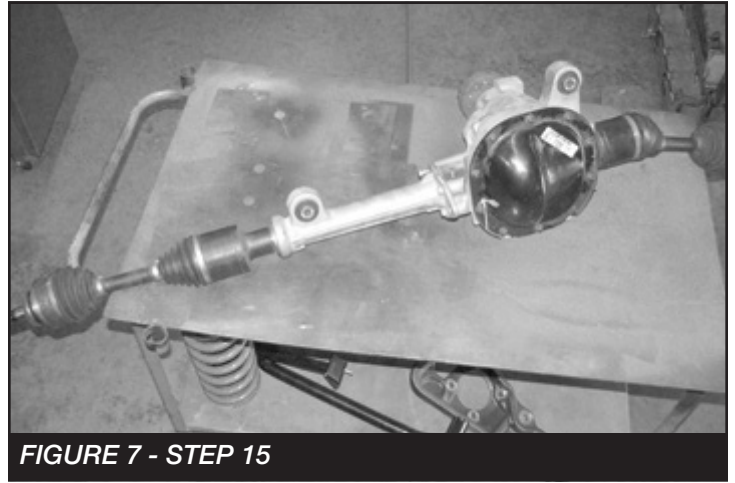
13. Remove the factory rear crossmember from the vehicle and discard the crossmember and hardware. **SEE FIGURE 6**



**FIGURE 6 - STEP 13**

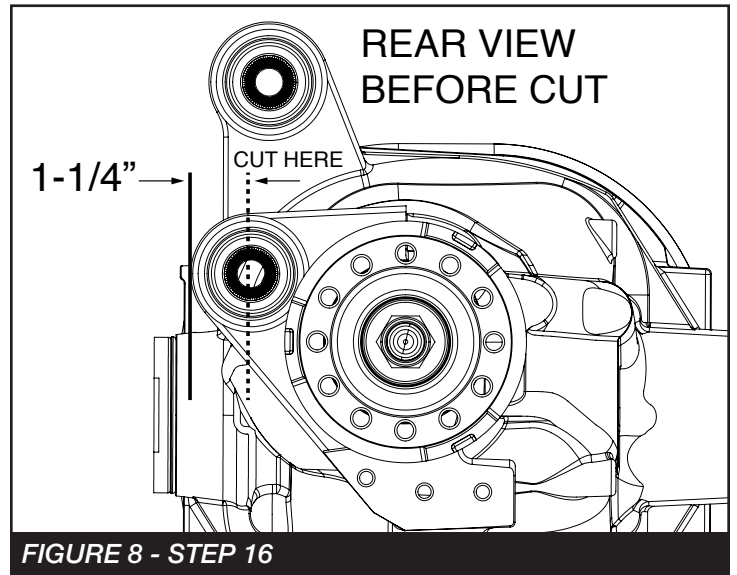
14. Remove the front drive shaft bolts where it attaches to the front differential. Support the end of the drive shaft before removing the front differential.

15. Remove the driver side rear differential mount hardware and discard. While supporting the differential, remove the two upper differential mount bolts and remove the differential and axles from the vehicle. Save the hardware. **SEE FIGURE 7**



**FIGURE 7 - STEP 15**

16. Locate rear differential housing mount closest to the pinion shaft. Mark the mount behind the bushing. Using a die grinder remove the mount and discard. **SEE FIGURES 8-11**



**FIGURE 8 - STEP 16**

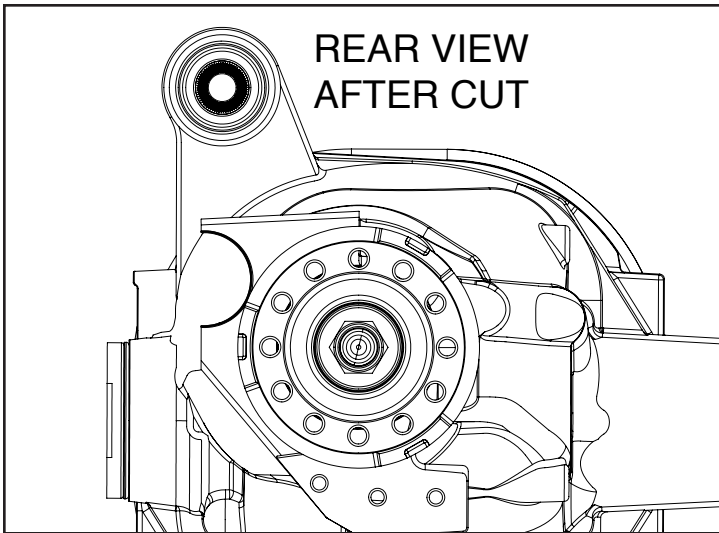


FIGURE 9 - STEP 16



FIGURE 10 - STEP 16

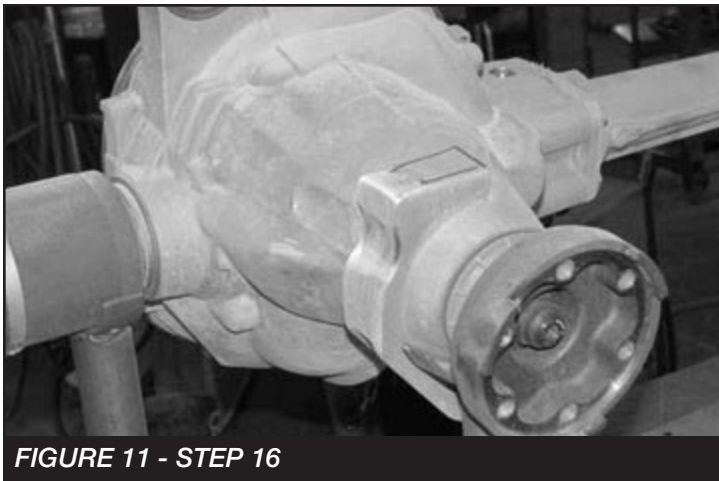


FIGURE 11 - STEP 16

17. Locate the driver side rear lower control arm pocket. Mark the frame 1-1/4" from the control arm pivot hole on the side of the hole closest to the center of the vehicle. Mark the frame from the bottom of the pivot 3/4" down. Using a die grinder, cut all the way around the pocket. Discard removed portion of the pocket. **SEE FIGURES 12-14**

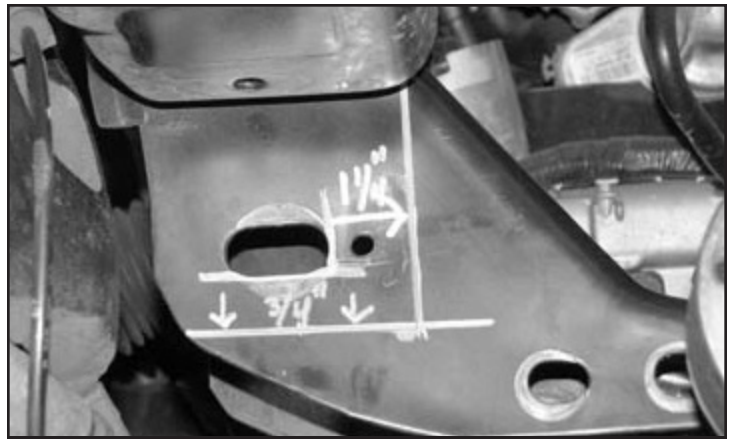


FIGURE 12 - STEP 17

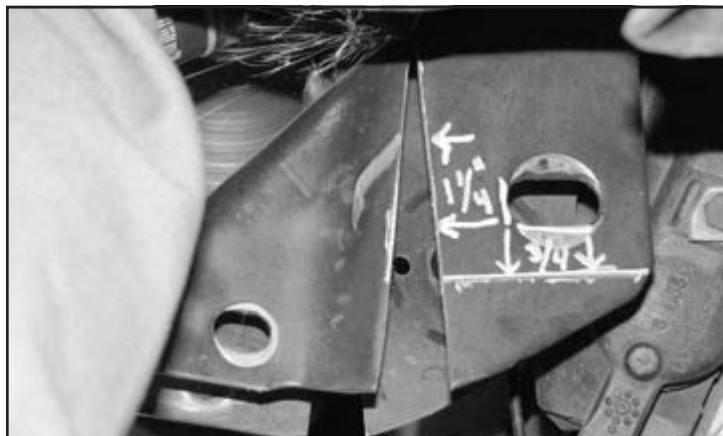


FIGURE 13 - STEP 17

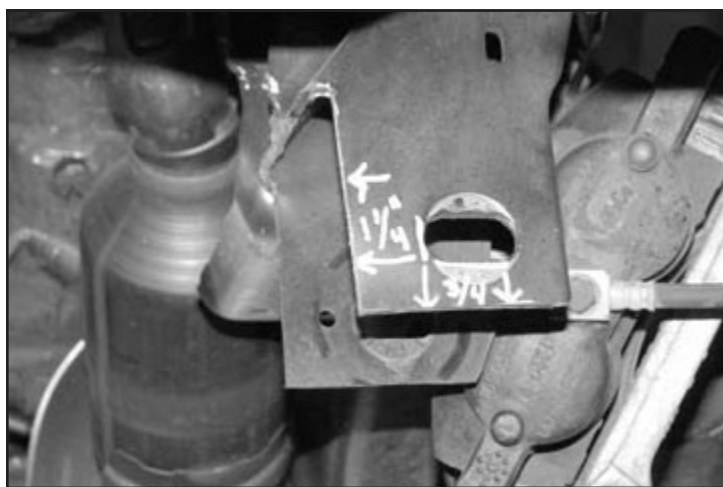


FIGURE 14 - STEP 17

18. Repeat this step on the passenger side rear control arm pocket. **SEE FIGURES 15-16**



**FIGURE 15 - STEP 18**



19. Returning to the driver side rear lower control arm pocket, locate the tab on the pocket closest to the front of the vehicle. You will need to sand a radius in the front side of the pocket in order to clear the differential housing. **SEE FIGURES 17-18**



**FIGURE 17 - STEP 19**



**FIGURE 18 - STEP 19**

20. Locate the two Fabtech upper differential mounts (FT30491). These upper differential mounts will be placed into the factory upper differential mounts using the factory upper differential mount hardware. Leave the hardware loose in preparation for the differential installation. **SEE FIGURES 19-20**



**FIGURE 19 - STEP 20**



**FIGURE 20 - STEP 20**

21. Locate the factory front differential and install into the Fabtech upper differential mounts using two 1/2"-13 x 4" hex cap bolts, washers and lock nuts. Leave all hardware loose in preparation of the installation of the remaining differential mounts. **SEE FIGURES 21-22**





FIGURE 21 - STEP 21

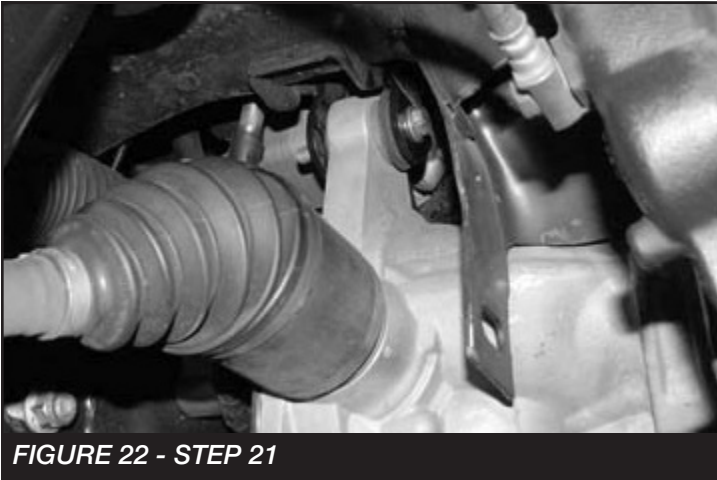


FIGURE 22 - STEP 21

22. Locate the Fabtech rear crossmember (FT30512BK). Install the rear crossmember in the factory rear lower control arm pockets. Mount the crossmember using the factory control arm pivot hardware. Leave all hardware loose. All the tabs on the face of the crossmember should be pointed to the rear of the vehicle. **SEE FIGURE 23**



FIGURE 23 - STEP 22

23. Remove the center differential housing bolts on the back side of the differential. **SEE FIGURE 24**



FIGURE 24 - STEP 23

24. Locate the center differential bracket (FT30567). Install two of the Fabtech (FT1020) bushings and one sleeve (FT181) into the barrel on the differential bracket. **SEE FIGURE 25**

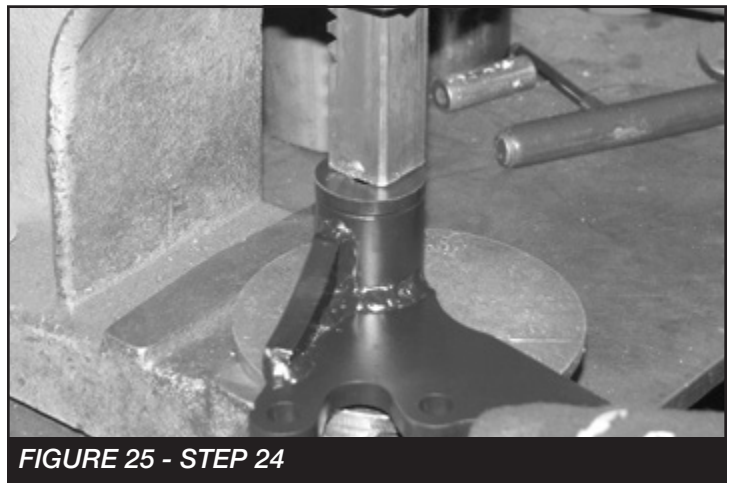


FIGURE 25 - STEP 24

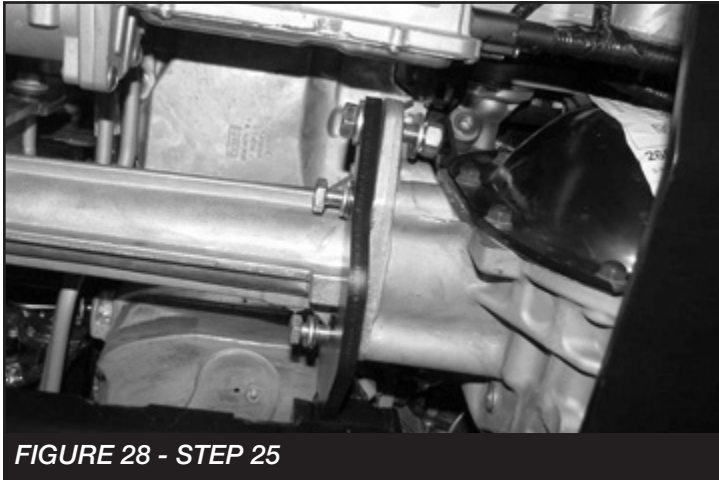
25. Mount the differential bracket to the center of the differential using three M10-1.5 x 45mm bolts, lock washers, and flat washers. Mount the front tab on the diff to the center bracket using one 1/2-13 x 2" bolt, nut and washers. Leave loose at this time. **SEE FIGURES 26-28**



FIGURE 26 - STEP 25



**FIGURE 27 - STEP 25**

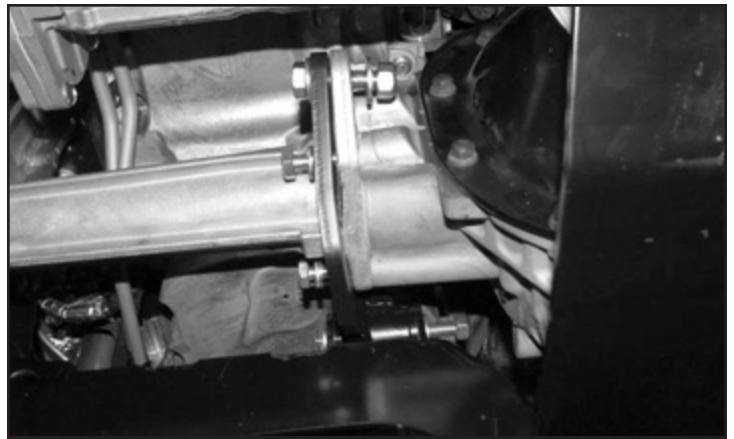


**FIGURE 28 - STEP 25**

26. Install a ½ -13 x 4" bolt washers and nut through the tabs on the rear crossmember and the bushing on the center bracket. Leave loose at this time. **SEE FIGURE 29-30**



**FIGURE 29 - STEP 26**



**FIGURE 30 - STEP 26**

27. Torque the M10-1.5 x 45mm bolts to 35 ft-lbs. Torque the ½-13 x 2" bolt to 90 ft-lbs.

28. Reinstall the front drive shaft with the factory hardware and torque to 35 ft-lbs. **SEE FIGURE 31**



**FIGURE 31 - STEP 28**

29. Locate the rear diff mount (FT30585BK). Install two of the Fabtech (FT1020) bushings and one sleeve (FT181) into the barrel on the differential bracket. **SEE FIGURE 32**



**FIGURE 32 - STEP 29**

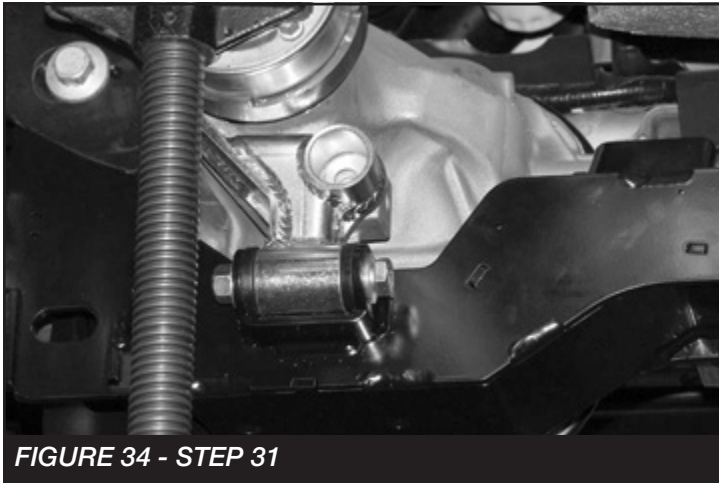
30. Install the rear diff bracket into the tabs on the rear crossmember using a ½-13 x 4" bolt, washers, and nut. **SEE FIGURE 33**



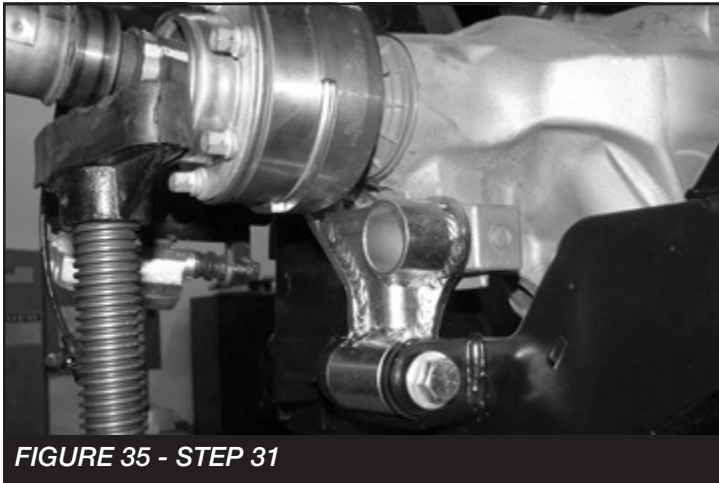
**FIGURE 33 - STEP 30**

31. Support the diff to make sure the block on the diff is centered with the hole in the rear bracket.

**SEE FIGURE 34-35**

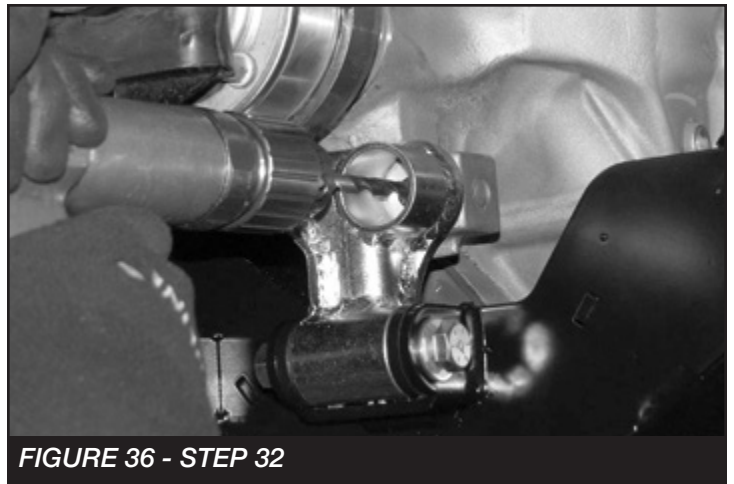


**FIGURE 34 - STEP 31**



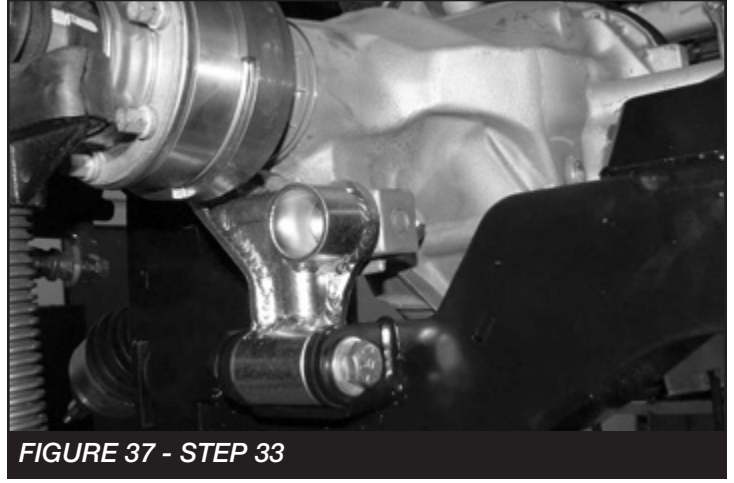
**FIGURE 35 - STEP 31**

32. Use the rear bracket as a drill guide to drill a  $\frac{1}{2}$ " hole through the block on the rear of the diff. **SEE FIGURE 36**



**FIGURE 36 - STEP 32**

33. Install a  $\frac{1}{2}$ -13 x 2-3/4" bolt, washers and nut through the bracket and diff. Torque the bolt in the diff to 90 ft-lbs and the bolt in the crossmember to 90 ft-lbs. **SEE FIGURE 37**

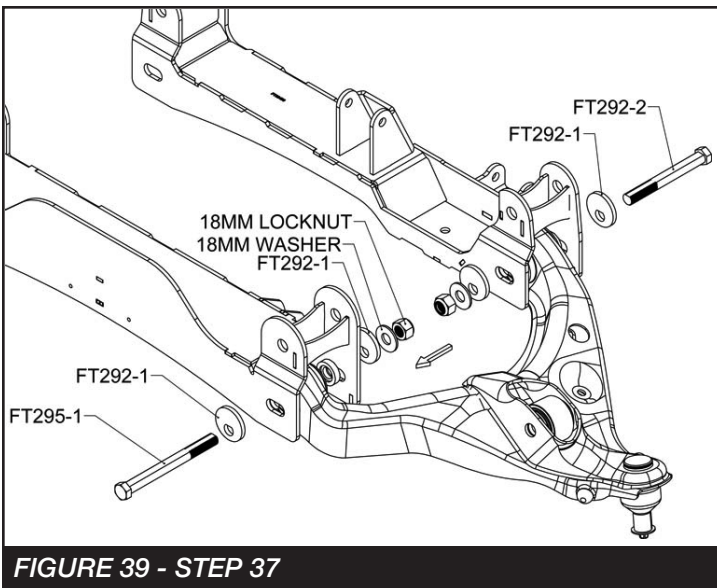


**FIGURE 37 - STEP 33**

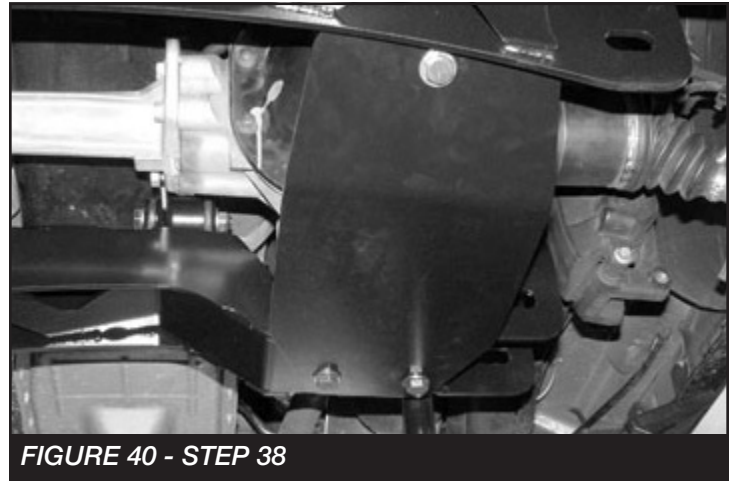
34. At this time locate upper differential brackets and torque the factory upper bolts to 90 ft-lbs and lower ½” bolts 127 ft-lbs. Locate the center diff mount on the cross member and torque the ½-13 x 4” bolt to 90 ft-lbs.
35. Reinstall the factory vent hose back on to the differential.
36. Locate the Fabtech front crossmember (FT30489BK). Install the front crossmember into the factory front control arm pockets using the factory hardware. Make sure the skid plate tab on the crossmember is facing the Fabtech rear crossmember. Leave the hardware loose at this time. **SEE FIGURE 38**



37. Locate the Alignment cam kit (FT295). Locate the factory control arms. Install the lower control arms into the Fabtech crossmembers using the hardware in the cam kit (FT295). Torque the cam bolts at 200 ft-lbs after alignment. **SEE FIGURE 39**

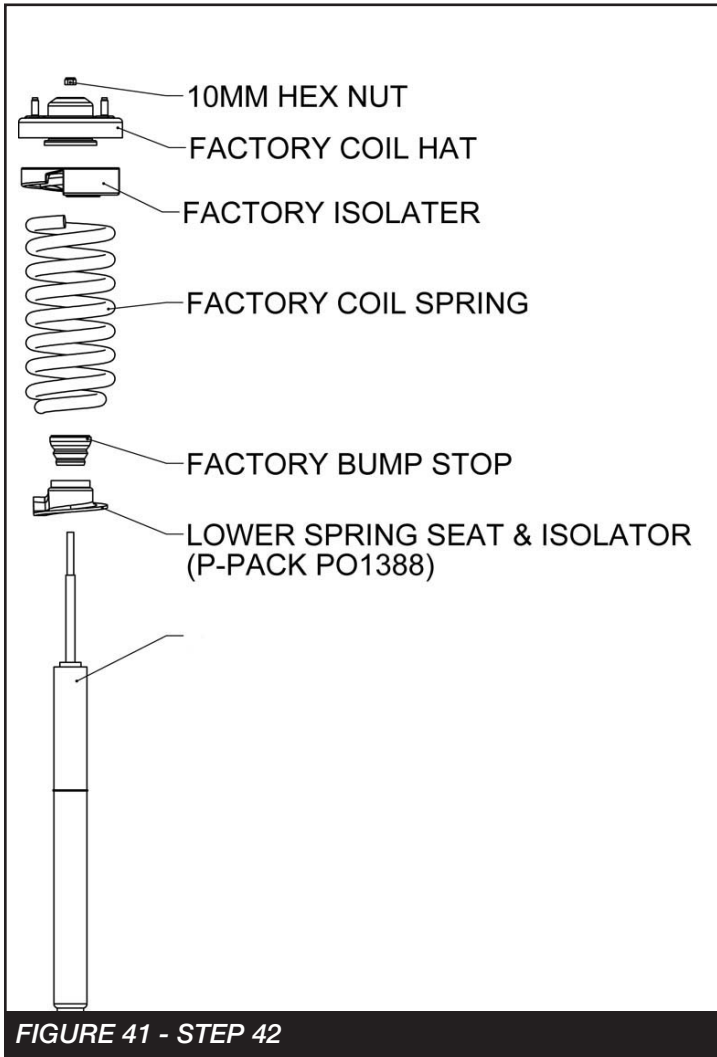


38. Locate the Fabtech skid plate (FT30377BK). The skid plate will span the distance between the front and rear crossmembers directly under the front differential. Attach the end of the skid plate with the single hole to the tab on the back side of the front crossmember using one ½”- 13 x 1” bolt, washers and a C-lock nut. Lift up the back side of the skid plate and install it to the rear crossmember using two ½”- 13 x 1” bolts, washers and a C-lock nut. Torque all hardware to 127 ft-lbs. **SEE FIGURE 40**



39. Torque the all upper factory crossmember bolts to 300 ft-lbs at this time.
40. If installing FTS22158 (Dirt Logic 2.5 coil over) do so at this time and skip steps 41-43.
41. Locate the factory coilovers and disassemble using a spring compressor. Retain the Factory coil hat, isolator, coil spring, and bump stop. Discard the factory shock and spring seat.

42. Locate FTS30502 (2009-2013) or FTS30503 (2014) Fabtech strut and spring seat. Assemble the shock using the retained factory components. Requires Spring Compressor for assembly. **SEE FIGURE 41**

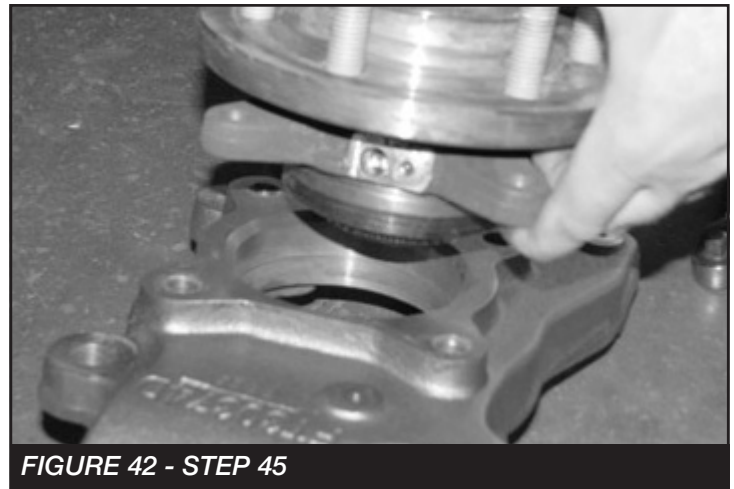


43. Install the top of the shock in the factory bucket using the factory nuts. Torque to 58 ft-lbs. **(2009-2013)** Install the lower end of the shock in to the control arm pocket using the factory 20mm hardware and torque to 300 ft-lbs. **(2014)** Install the lower strut to the lower control arm using the supplied 1/2" x 3" bolts, nuts and washers. Torque to 127 ft-lbs.

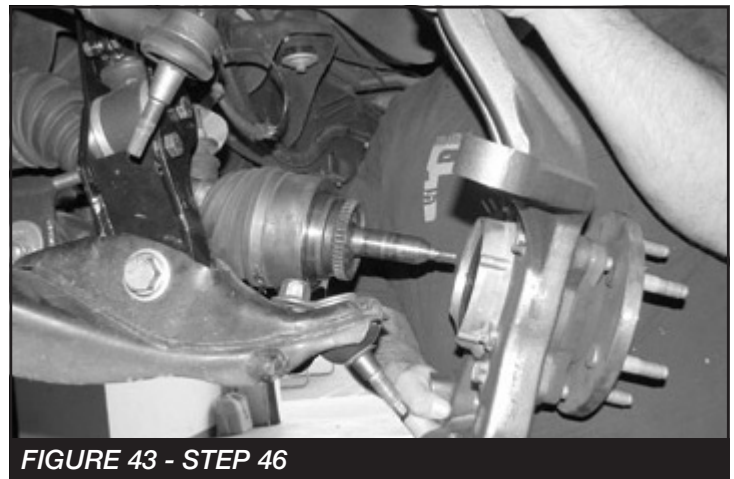
44. **NOTE: Specific IWE "Integrated Wheel End" installation procedures are necessary when servicing and/or IWE vacuum is released. When the IWE actuator is loosened at the knuckle and/or removed from CV shaft:**

- Remove the two vacuum line, compress the IWE actuator and install a vacuum cap on the larger vacuum port (to keep it compressed).
- Install the IWE actuator onto the halfshaft outer end (if removed).
- Do not dislodge the IWE seal spring when installing an IWE on a CV halfshaft outboard end or component damage may occur.

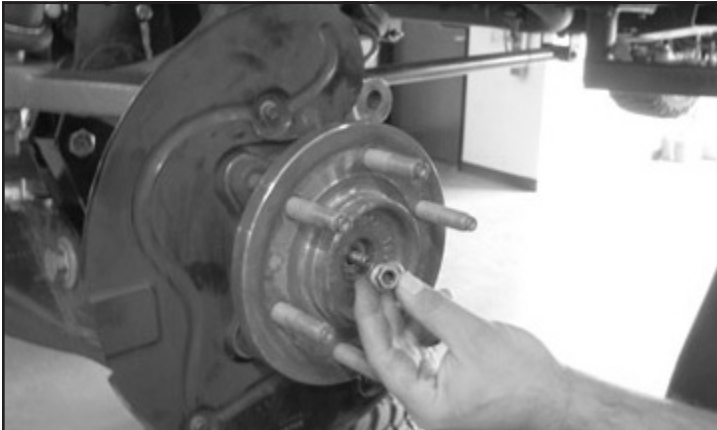
- Allow the wheel knuckle to swing outward while keeping the halfshaft pushed inward.
  - Once clearance is available, install the halfshaft outboard end into the wheel knuckle hub bearing.
  - Connect the upper ball joint and install new nut; torque to 85 ft-lbs.
  - Install the three IWE actuator to wheel knuckle retaining bolts; torque to 106 ft-lbs
  - Remove the IWE vacuum cap and reconnect the vacuum tubes.
  - Verify the spline engagement by checking for spline lash before installing the axle nut or component damage may occur.
  - Install new axle nut; 30 ft-lbs
45. Locate the Fabtech driver side spindle (FTS30494D) and install the factory hub. Torque the four 14mm bolts to 160 ft- lbs. **SEE FIGURE 42**



46. Install the Fabtech spindle onto the upper and lower control arms. Torque the upper ball joint to 85 ft-lbs and the lower ball joint to 110 ft-lbs. **SEE FIGURE 43**

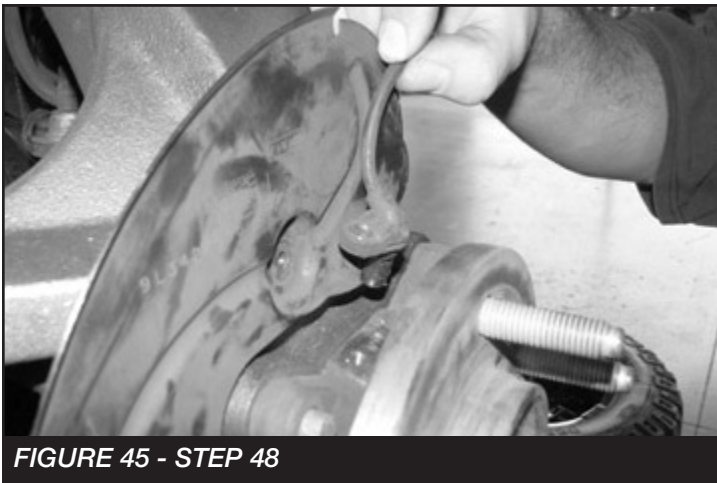


47. Install the dust shield and torque to 14 ft-lbs. Install CV shaft nut and torque to 35 ft-lbs. Install the factory dust cover. **SEE FIGURE 44**



**FIGURE 44 - STEP 47**

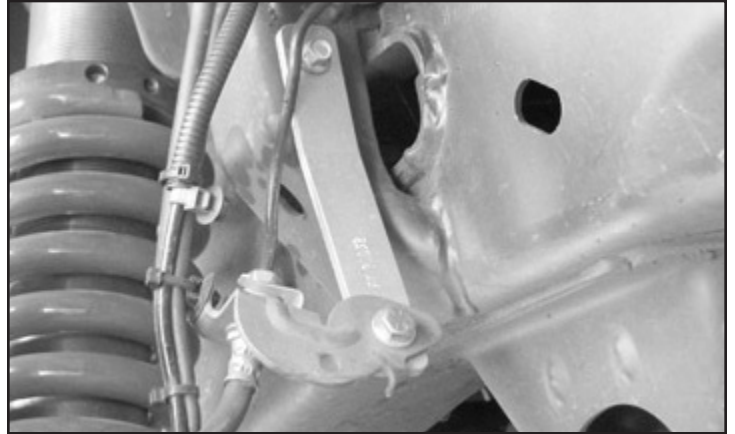
48. Install the wheel speed sensor. Make sure the end of the sensor is clean. **SEE FIGURE 45**



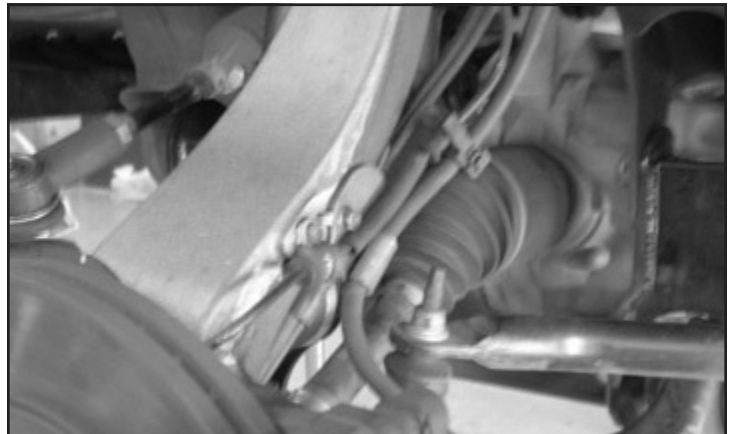
**FIGURE 45 - STEP 48**

49. Carefully pull some slack from the frame side and reconnect the vacuum line to the hub assembly. Install the Fabtech frame brake line bracket (FT30496). Using the factory hardware, mount factory brake line bracket to the side of the Fabtech knuckle. After installing the factory brake line bracket, check to insure full movement by steering the knuckle back and forth, and make sure none of the ABS lines, brake lines, or vacuum lines are over stretched during full test movement of the knuckle.

**SEE FIGURES 46-47**



**FIGURE 46 - STEP 49**



**FIGURE 47 - STEP 49**

50. Reinstall the original brake rotor, followed by the brake caliper. Use a small amount of the supplied thread lock compound on the caliper bolts and torque to 145 ft.-lbs. **SEE FIGURES 48-49**

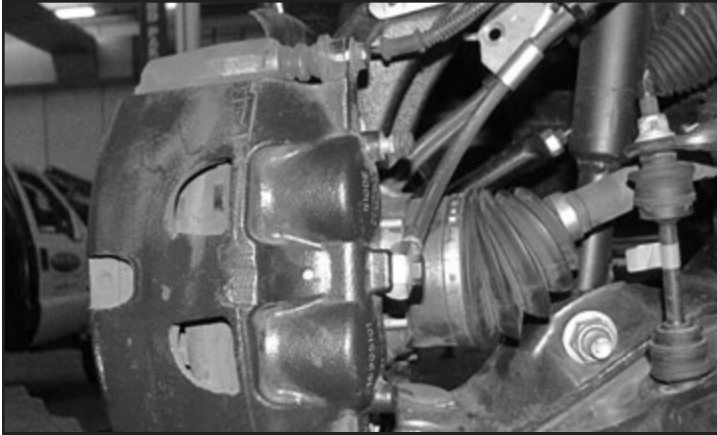


FIGURE 48 - STEP 50

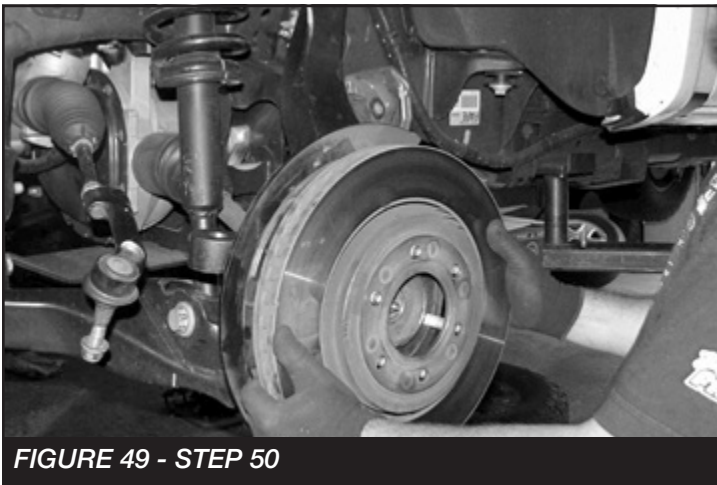


FIGURE 49 - STEP 50

51. Reconnect the tie rod end to the steering knuckle and torque to 60 ft.-lbs.

52. Install FT30492 & FT30493 (sway bar brackets) to the frame using the factory hardware. Next, install the sway bar to the new brackets using the supplied 3/8 X 1-1/4" bolts, nuts and washers. Install the factory sway bar link in to the end of the sway bar and lower control arm mounting. Torque Brackets and links to 52 ft.-lbs. **SEE FIGURE 50**

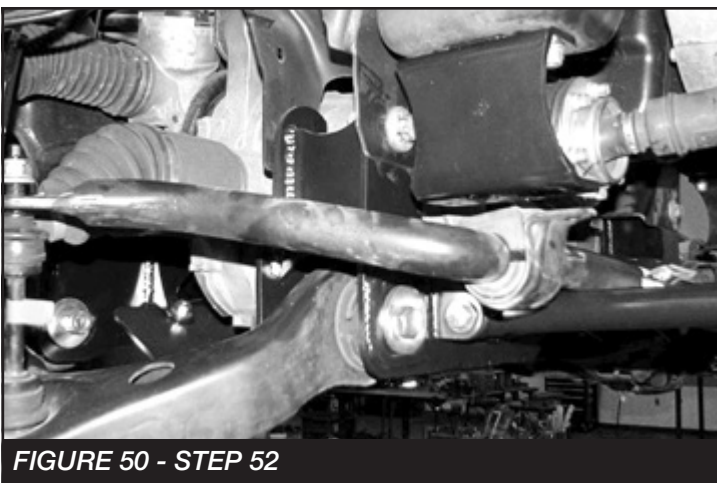


FIGURE 50 - STEP 52

53. Install front tires. Cut the front fender well as show the pictures below for 35" tires. **SEE FIGURES 51-56**

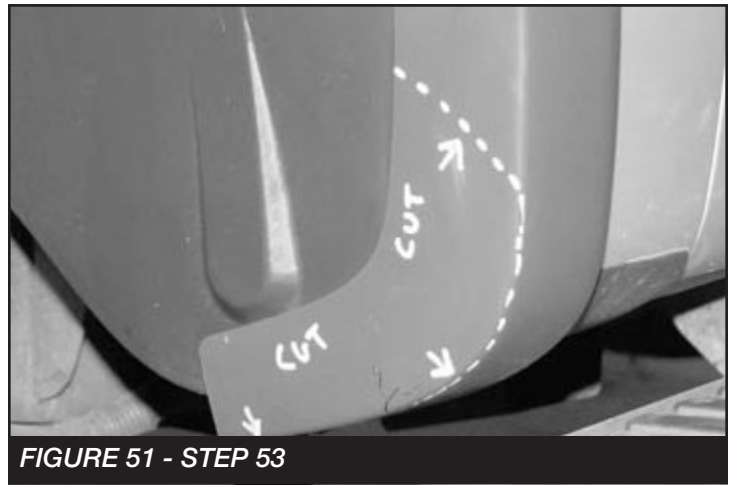


FIGURE 51 - STEP 53

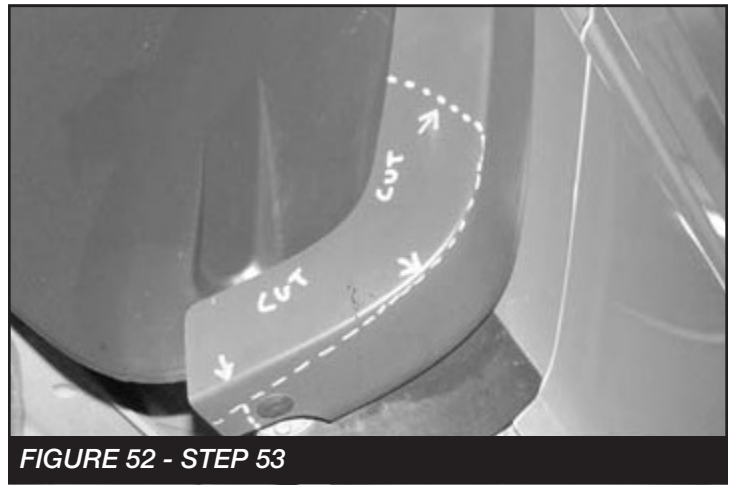


FIGURE 52 - STEP 53



FIGURE 53 - STEP 53



FIGURE 54 - STEP 53



FIGURE 55 - STEP 53



FIGURE 56 - STEP 53

## REAR SUSPENSION

54. Jack up the rear end of the vehicle and support the frame rails with jack stands. Release the parking brake at this time. Supporting the rear differential, remove the rear shocks, u-bolts, blocks and lower axle down. Use care not to over extend the brake hose.
55. Locate the factory brake line mount on the driver side of the frame. Locate the Fabtech brake line bracket (FT70033) and attach the bracket between the factory frame mount and the factory brake line using the 5/16 X 1" hardware. **SEE FIGURE 57**

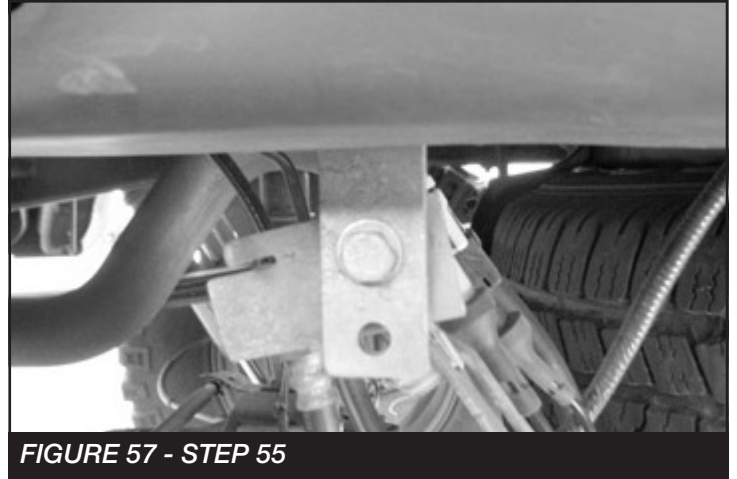


FIGURE 57 - STEP 55

56. Locate and install the rear lift blocks FTBK22. The extended bump stop perch will be facing inboard of the truck. Using the Fabtech u-bolts, nuts and washers, align the axle, lift blocks, and springs and torque u-bolts to 129 ft-lbs. **SEE FIGURE 58**



FIGURE 58 - STEP 56



57. Install the shocks that were supplied using the factory hardware and torque upper and lower bolts to 45 ft-lbs.
58. Install tires and wheels and torque lug nuts to wheel manufacturer's specifications. Turn front tires left to right and check for appropriate tire clearance. **Note - Some oversized tires may require trimming of the front bumper & valance.**
59. Check front end alignment and set to factory specifications. Readjust headlights.
60. Recheck all bolts for proper torque.
61. Recheck brake hoses, ABS wires and suspension parts for proper tire clearance while turning tires fully left to right.
62. Check the fluid in the front and rear differential and fill if needed with factory specification differential oil. **Note - some differentials may expel fluid after filling and driving. This can be normal in resetting the fluid level with the new position of the differential/s.**
63. Install Driver Warning Decal. Complete product registration card and mail to Fabtech in order to receive future safety and technical bulletins on this suspension.

**Vehicles that will receive oversized tires should check ball joints and all steering components every 2500-5000 miles for wear and replace as required.**

**RETORQUE ALL NUTS, BOLTS AND LUGS  
AFTER 50 MILES AND PERIODICALLY  
THEREAFTER.**

For technical assistance call: 909-597-7800

## - Product Warranty and Warnings -

Fabtech provides a Limited Lifetime Warranty to the original retail purchaser who owns the vehicle, on which the product was originally installed, for defects in workmanship and materials.

The Limited Lifetime Warranty excludes the following Fabtech items; bushings, bump stops, ball joints, tie rod ends, limiting straps, cross shafts, heim joints and driveshafts. These parts are subject to wear and are not considered defective when worn. They are warranted for 60 days from the date of purchase for defects in workmanship.

Dirt Logic and Performance Coilover take apart shocks are considered a serviceable shock with a one year warranty on leakage only. Service seal kits are available separately for future maintenance. All other shocks are covered under our Limited Lifetime Warranty.

Fabtech does not warrant any product for finish, alterations, modifications and/or installation contrary to Fabtech's instructions. Alterations to the finish of the parts including but not limited to painting, powder coating, plating and/or welding will void all warranties. Some finish damage may occur to parts during shipping, which is considered normal and is not covered under warranty.

Fabtech products are not designed nor intended to be installed on vehicles used in race applications or for racing purposes or for similar activities. (A "RACE" is defined as any contest between two or more vehicles, or any contest of one or more vehicle against the clock, whether or not such contest is for a prize). This warranty does not include coverage for police or taxi vehicles, race vehicles, or vehicles used for government or commercial purposes. Also excluded from this warranty are sales outside of the United States of America.

Installation of most suspension products will raise the center of gravity of the vehicle and will cause the vehicle to handle differently than stock. It may increase the vehicle's susceptibility to a rollover, on road and off road, at all speeds. Extreme care should be taken to operate the vehicle safely at all times to prevent rollover or loss of control resulting in serious injury or death. Fabtech front end Desert Guards may impair the deployment or operation of vehicles equipped with supplemental restraining systems/air bag systems and should not be installed if the vehicle is equipped as so.

Fabtech makes every effort to ensure suspension product compatibility with all vehicles listed on the website, but due to unknown auto manufacturer's production changes and/or inconsistencies by the auto manufacturer, Fabtech cannot be responsible for 100% compatibility, including the fitment of tire and wheel sizes listed. The Tire and Wheel sizes listed in Fabtech's website are only a guideline for street driving with noted fender trimming. Fabtech is not responsible for damages to the vehicle's body or tires. Fabtech is not responsible for premature wear of factory components due to the installation of oversized tires and wheels.

Fabtech's obligation under this warranty is limited to the repair or replacement, at Fabtech option, of the defective product only. All costs of removal, installation or re-installation, freight charges, incidental or consequential damages are expressly excluded from this warranty. Fabtech is not responsible for damages and/or warranty of other vehicle parts related or non related to the installed Fabtech product. This warranty is expressly in lieu of all other warranties expressed or implied. This warranty shall not apply to any product that has been subject to accident, negligence, alteration, abuse or misuse as determined by Fabtech.

Fabtech suspension components must be installed as a complete system including shocks as shown on our website. All warranties will become void if Fabtech parts are combined and/or substituted with other aftermarket suspension products. Combination and/or substitution of other aftermarket suspension parts may cause premature wear and/or product failure resulting in an accident causing injury or death. Fabtech does not warrant products not manufactured by Fabtech.

Depending on the condition of the factory suspension components retained after the installation of a Fabtech suspension not all vehicles may have the same ride stance front to rear as described in the website. The blue color of suspension components shown in all Fabtech photographs are for display purposes only. Majority of all Fabtech components will be black specifically where noted with part numbers ending in BK.

Installation of Fabtech product may void the vehicles factory warranty; it is the consumer's responsibility to check with their local vehicle's dealer for warranty disposition before the installation of the product. Some state laws may prohibit modification of suspension to a vehicle in whole or in part. It is the responsibility of the installer and consumer to consult local laws prior to the installation of any Fabtech suspension product to comply with such written laws.

It is the responsibility of the distributor and/or the retailer to review all warranties and warnings of Fabtech products with the consumer prior to purchase.

Fabtech reserves the right to super cede, discontinue, change the design, finish, part number and/or application of parts when deemed necessary without written notice. Fabtech is not responsible for misprints or typographical errors within the website or price sheet. For the most recent Product Warranty and Warnings visit our website [www.fabtechmotorsports.com](http://www.fabtechmotorsports.com)