

FENDER FLARES INSTALLATION INSTRUCTIONS FRONT FENDERS

FF 650a
1/3

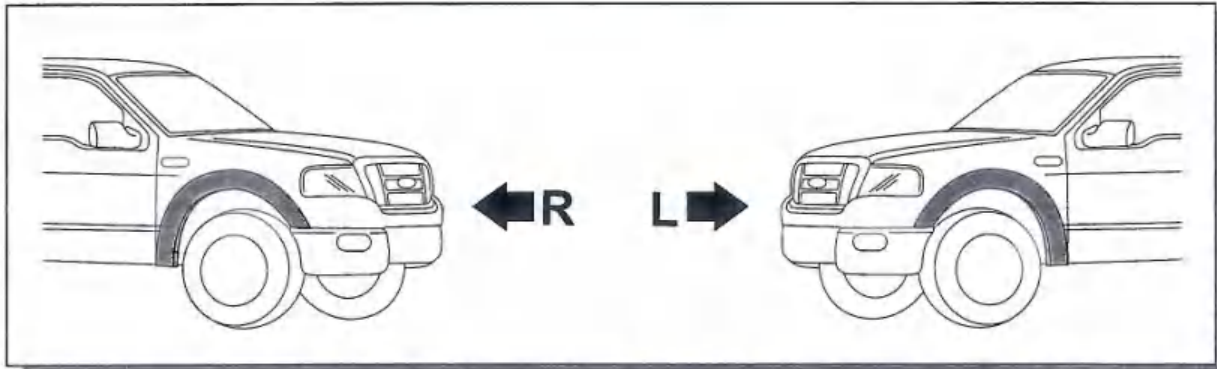

1. Ensure that both left and right hand Fender Flares suit the profile of the vehicle. Note the areas where the Fender Flares come in contact with the vehicle. **NOTE:** Before fitting Fender Flares remove any mouldings, strips or existing flares from the wheel arch. If there is a body side moulding, mark where the moulding is to be cut, alternatively the Fender Flares can be cut to go around the moulding. Be sure to allow enough room for the extrusion.

PAINTING INSTRUCTIONS – If Fender Flares are being painted, do not install edge extrusion until painting is complete. Prior to painting, clean all surfaces to be painted using clean water and a mild detergent, do not use lacquer thinner or any solvent based products. Wipe completely dry. Best results will be achieved by wiping the areas to be painted with a tack rag just prior to painting. Most automotive paints can be applied directly to the Fender Flares, however some may require a primer (check paint manufacturer specifications). Good adhesion will be achieved without sanding. Select a paint (and primer if necessary) that is suitable for rigid plastics PMMA (Acrylic). If using a paint system which requires baking, do not expose the product to temperatures above 70°C (158°F). Do not fit the extrusion or any of the hardware to the Fender Flares until the paint is completely dry.

IMPORTANT: For bolt-on Fender Flares proceed to **Step 2**. For rugged Fender Flares proceed to **Step 3**.

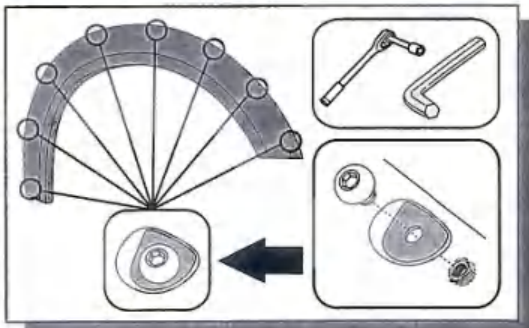

2. Attach 9 bolts to each Fender Flare using a 3/16" Allen key and a 1/2" wrench/socket. (socket wrench and Allen key not supplied)

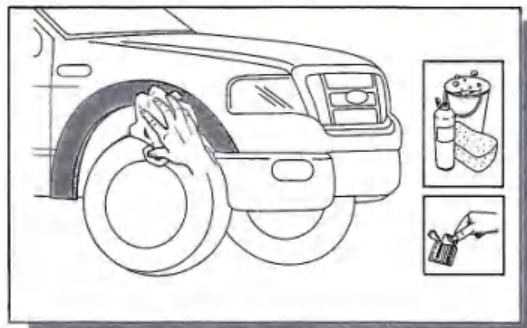

3. Wash the areas of contact on the vehicle and wipe dry both the vehicle and the Fender Flares with a clean cloth. Ensure inside of Fender Flares where extrusion is attached is clean, use alcohol wipe supplied to clean surface.

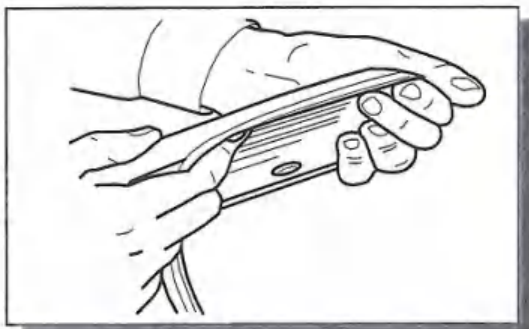

4. Remove approximately 2" (50mm) of the protective liner from the extrusion. Fit the extrusion to the Fender Flare along the edge that comes in contact with the vehicle's body panel.

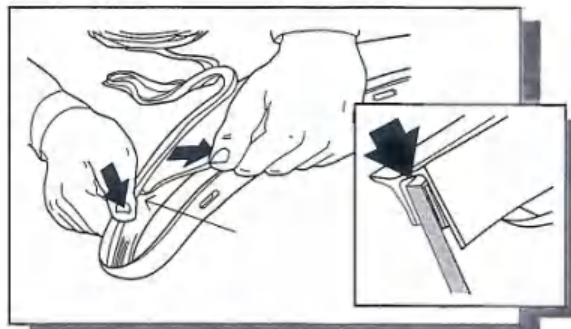

5. Pulling at right angles to the extrusion, remove the liner from the extrusion in small portions and apply thumb pressure to ensure that it adheres to the Fender Flares.

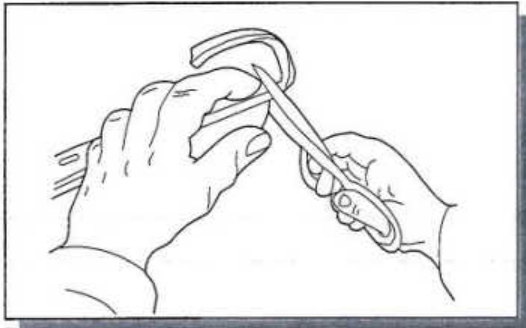

6. Trim any unnecessary extrusion and discard.

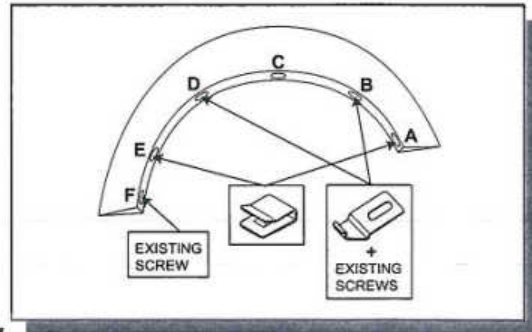

7. Note the correct hardware for positions A, B, D, E & F (Right Fender Flare shown).

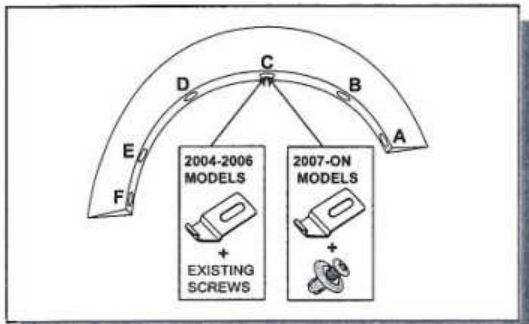

8. Note the correct hardware for position C (Right Fender Flare shown).

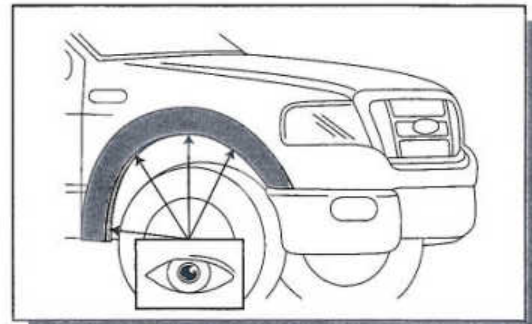

9. Place the Fender Flare on the vehicle into the position of best fit. Note where the slots in Fender Flare at positions B, C, D and F align with the existing screws in the vehicle. Remove Fender Flare.

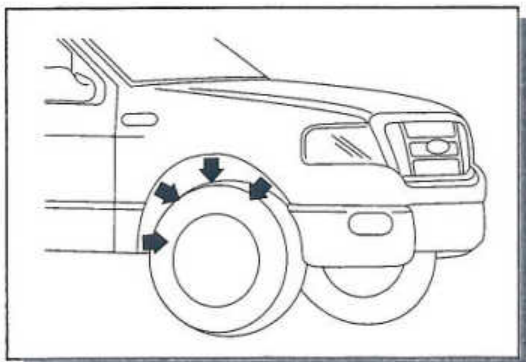

10. Remove the previously noted existing screws and retain for re-installation.

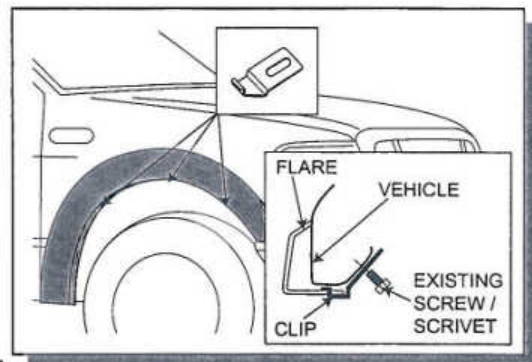

11. Place Fender Flare on the vehicle. Using the lever clips provided, install them into positions B, C and D, by locating the leg of clip into slot in Fender Flare and then secure clips to vehicle using the previously removed screws or scrivet for 2007-on models as shown.

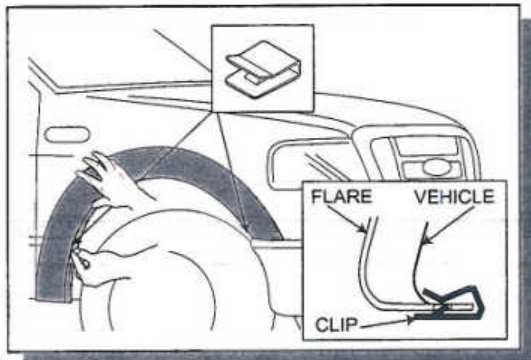

- 12.** Take the supplied snap clips and fix them into positions **A** and **E**, as shown, ensuring the notch in clip locates securely into the slot in the Fender Flare.

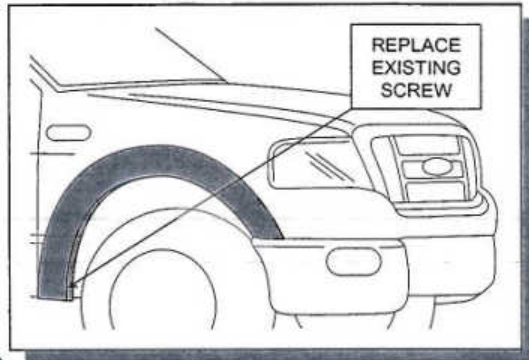

- 13.** Complete installation by replacing the previously removed screw at position **F**, ensuring the Fender Flare is located over the black trim.

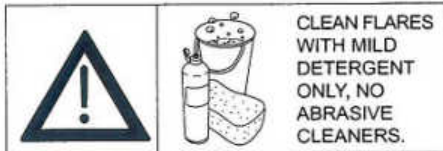

CLEAN FLARES WITH MILD DETERGENT ONLY, NO ABRASIVE CLEANERS.