



**HYDRAULIC WINCH**  
**10000NW**  
**15000NW**

**Assembly & Operating Instructions**

---

## **CONTENTS**

<b>INTRODUCTION .....</b>	<b>1</b>
<b>SAFETY WARNINGS AND PRECAUTIONS.....</b>	<b>2</b>
<b>WINCH WARNINGS AND PRECAUTIONS .....</b>	<b>3</b>
<b>UNPACKING .....</b>	<b>4</b>
<b>INSTALLATION.....</b>	<b>4</b>
<b>OPERATION .....</b>	<b>8</b>
<b>WINCH ACCESSORIES YOU WILL NEED.....</b>	<b>9</b>
<b>RIGGING TECHNIQUES .....</b>	<b>9</b>
<b>LUBRICATION .....</b>	<b>10</b>
<b>CABLE ASSEMBLY REPLACEMENT.....</b>	<b>10</b>
<b>TROUBLE SHOOTING.....</b>	<b>11</b>
<b>WINCH ASSEMBLY DRAWING 10000NW .....</b>	<b>1 2</b>
<b>WINCH PARTS LIST 10000NW .....</b>	<b>1 3</b>
<b>WINCH ASSEMBLY DRAWING 15000NW .....</b>	<b>1 4</b>
<b>WINCH PARTS LIST 15000NW .....</b>	<b>1 5</b>
<b>SPECIFICATION(10000NW).....</b>	<b>1 6</b>
<b>SPECIFICATION(15000NW).....</b>	<b>1 7</b>

## **INTRODUCTION**

We have developed a several new series that make up the current product line. Each series in our product line has unique design characteristics; many new patented technologies are integrated into our winches. Your HWP series winch is part of our new product line and has its own salient features: two speeds, single shaft clutch and speed control, and automatic reducer gear engagement. There are three positions of reducer gear engagement, high gear, low gear, and free spool. This new technology has made winches the pinnacle in user convenience and reliability. You will take pride in knowing that your new winch has been designed to work as hard as you and that it will be there when you need it.

Congratulations on your purchase of a highest class advanced powerful two speed winch. We design and build winches to strict specifications and with proper use and maintenance should bring you years of satisfying service.

 **WARNING** - Read, study and follow all instructions before operating this device. Failure to heed these instructions may result in personal injury and/or property damage.

Your winch can develop tremendous pulling forces and if used unsafely or improperly could result in property damage, serious injury or death. Throughout this manual you will find the following symbols for caution, warning and danger. Pay particular attention to the notes preceded by these symbols as they are written for your safety. Ultimately, safe operation of this device rests with you, the operator.



This indicates a potentially hazardous situation which, if not avoided, may result in minor or moderate injury. This notation is also used to alert you against unsafe practices.





This indicates a potentially hazardous situation which, if not avoided, could result in death or serious injury.

## **SAFETY WARNINGS AND PRECAUTIONS**

 **WARNING:** When using the tool, basic safety precautions should always be followed to reduce the risk of personal injury and damage to the equipment. Read all this instructions before using this tool!

 **WARNING – Do not use winch to lift (vertically).**

 **WARNING – Keep children away.** Children must never be allowed in the work area Do not let them handle machines, tools, or extension cords.

 **WARNING – Store idle equipment.** When not in use, tools must be stored in a dry location to inhibit rust. Always lock up tools and keep out of reach of children.

 **WARNING – Dress properly.** Do not wear loose clothing or jewelry as they can be caught in moving parts. Protective, electrically non-conductive clothes and non-skid footwear are recommended when working. Wear restrictive hair covering to contain long hair.

 **WARNING – Use eye and ear protection.** Always wear impact safety goggles. Wear a full face shield if you are producing metal filings or wood chips. Wear a dust mask or respirator when working around metal, wood, and chemical dusts and mists.

 **WARNING – Maintain tools with care.** Keep tools sharp and clean for better and safer performance. Follow instructions for lubricating and changing accessories. Inspect tool cords periodically and, if damaged, have them repaired by an authorized technician. The handles must be kept clean, dry, and free from oil and grease at all times.

 **WARNING – Disconnect switch.** Unplug switch when not in use.

 **WARNING – Stay alert.** Watch what you are doing, use common sense. Do not operate any tool when you are tired.

 **WARNING – Check for damaged parts.** Before using any tool, any part that appears damaged should be carefully checked to determine that it will operate properly and perform its intended function. Check for alignment and binding of moving parts; any broken parts or mounting fixtures; and any other condition that may affect proper operation. Any part that is damaged should be properly repaired or replaced by

a qualified technician. Do not use the tool if any switch does not turn “On” and “Off” properly.

 **WARNING – Replacement parts and accessories.** When servicing, use only identical replacement parts. Use of any other parts will void the warranty. Only use accessories intended for use this tool.

 **WARNING – Do not operate tool if under the influence of alcohol or drugs.** Read warning labels on prescription to determine if your judgment or reflexes are impaired while taking drugs. If there is any doubt, do not operate the tool.

## **WINCH WARNINGS AND PRECAUTIONS**

 **WARNING** – Keep hands and body away from Fairlead (cable intake slot) when operating.

 **WARNING** – Secure vehicle in position before using winch.

 **WARNING** – Be certain winch is properly bolted to a structure (or vehicle) that can hold the winch load.

 **WARNING** – Do not use inappropriate attachments to extend the length of the winch cable.

 **WARNING** – Never lift people or hoist loads over people.

 **WARNING** – Never come in between the winch and the load when operating.

 **WARNING** – Do not apply load to winch when cable is fully extended. Keep at least 5 full turns of cable on the spool.

 **WARNING** – After moving an item with the winch, secure the item. Do not rely on the winch to hold it for an extended period.

 **WARNING** – Examine winch before using. Components may be affected by exposure to chemicals, salts, and rust.

 **WARNING** – Never operate winch if cable shows any signs of weakening, such as knotting or kinking.

 **WARNING** – Do not cross over or under cable when the winch is under load.

 **WARNING** – Do not move your vehicle with the cable extended and attached to the load. You could easily exceed the winch rating and snap the cable.

 **WARNING** – Use gloves while handling cable.

 **WARNING** – When the vehicle is parked on an incline you should use wheel chocks.

 **WARNING** – Re-spool cable properly avoiding cable misalignment.

 **WARNING** – The winch cable must be wound onto the drum under a load of at least 10% of the rated line pull or the outer wraps will draw into inner wraps and damage winch cable

 **WARNING** – Before operating the winch under load you should check proper function of the winch by engaging and disengaging the clutch, by operating the directional controls, and operating the speed controls. This will ensure that the winch is working properly and will help prevent unintended damage and injury. Cycling the winch prior to loading will also ensure the gears are properly aligned.

## **UNPACKING**

When unpacking, check to make sure all parts are included. Refer to Assembly Drawings and Parts List (both with the like item numbers) at the end of this manual.

## **INSTALLATION**

1. Your winch is designed with a bolt pattern that is standard in this class of winch. Many winch mounting kits are available that utilize this bolt pattern for the most popular vehicle and mounting channels. If you cannot find a kit locally, contact us and we will provide you with the name of a dealer near you. If you will utilize the mounting channel you must ensure that it is mounted on a flat surface so that the three major sections (motor, drum and gear housing) are properly aligned. Proper alignment of the winch will allow even distribution of the full rated load.
2. Mount winch to the vehicle using high strength cap screw. It should be aligned and secured to a solid part of the vehicle (front or rear) where the the full rated load will be evenly distributed.

3. Please refer to installation illustration.

**Working hydraulic principle chart and installation illustration:**

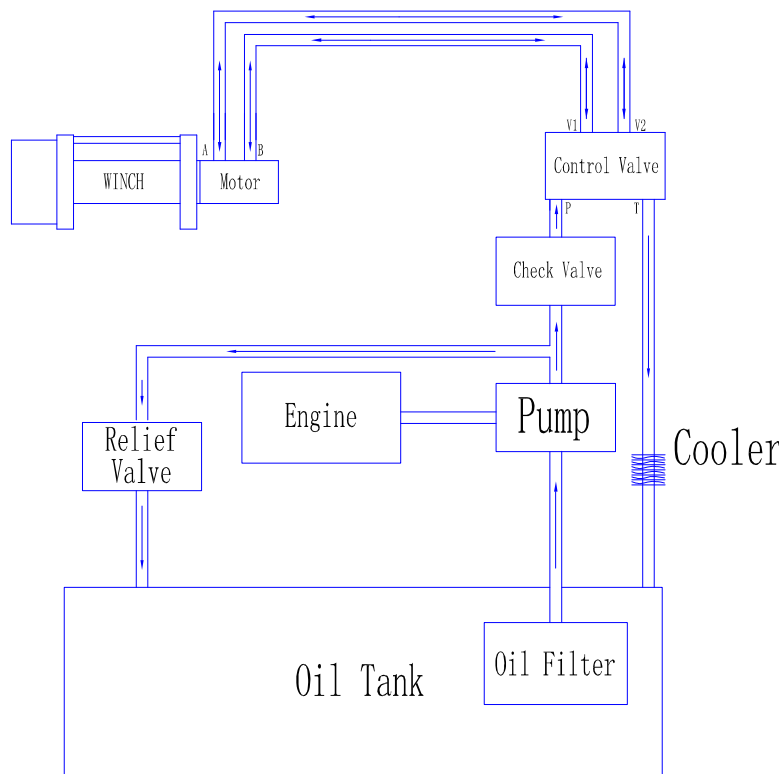
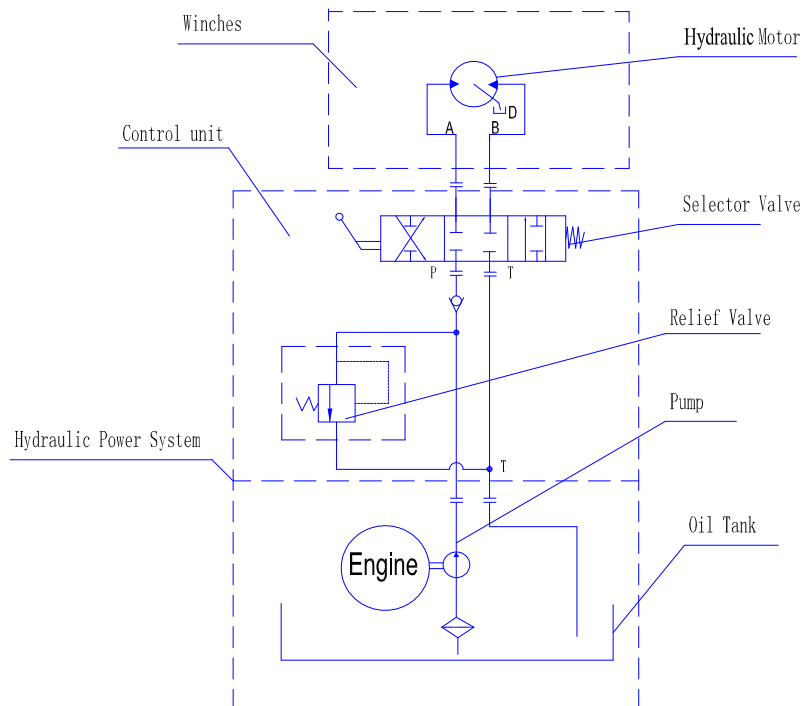

**Below is installation illustration of 10000NW:**

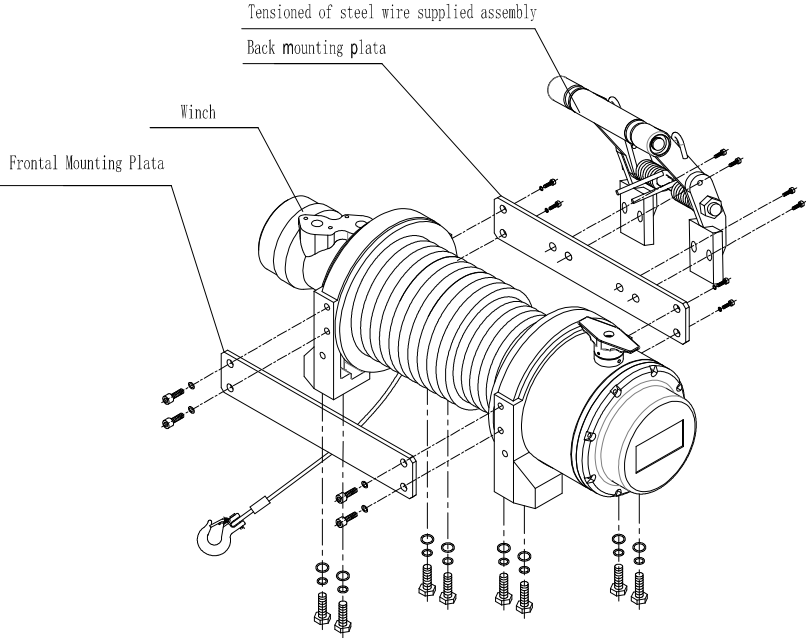

**Below is installation illustration with roller fairlead of 10000NW:**

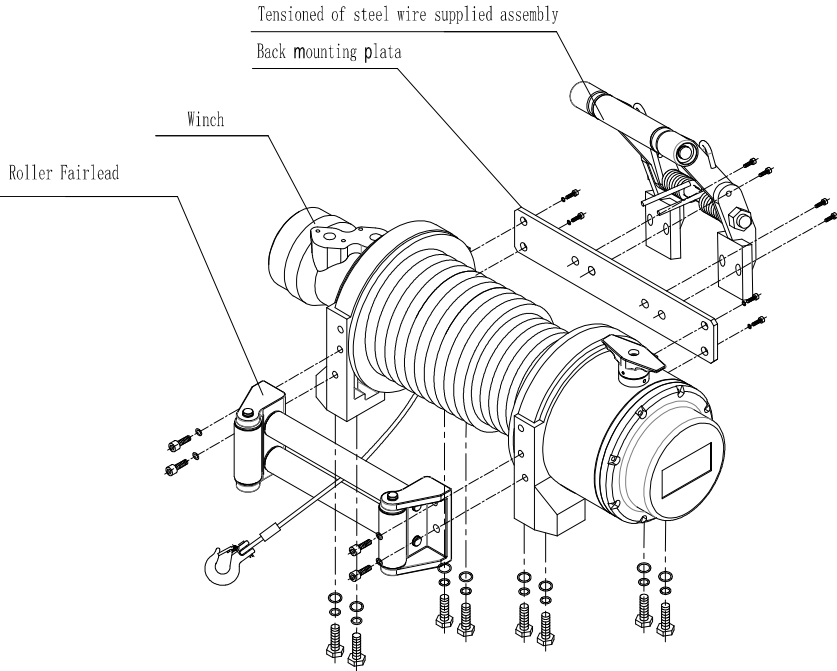



**Below is installation illustration of 15000NW:**

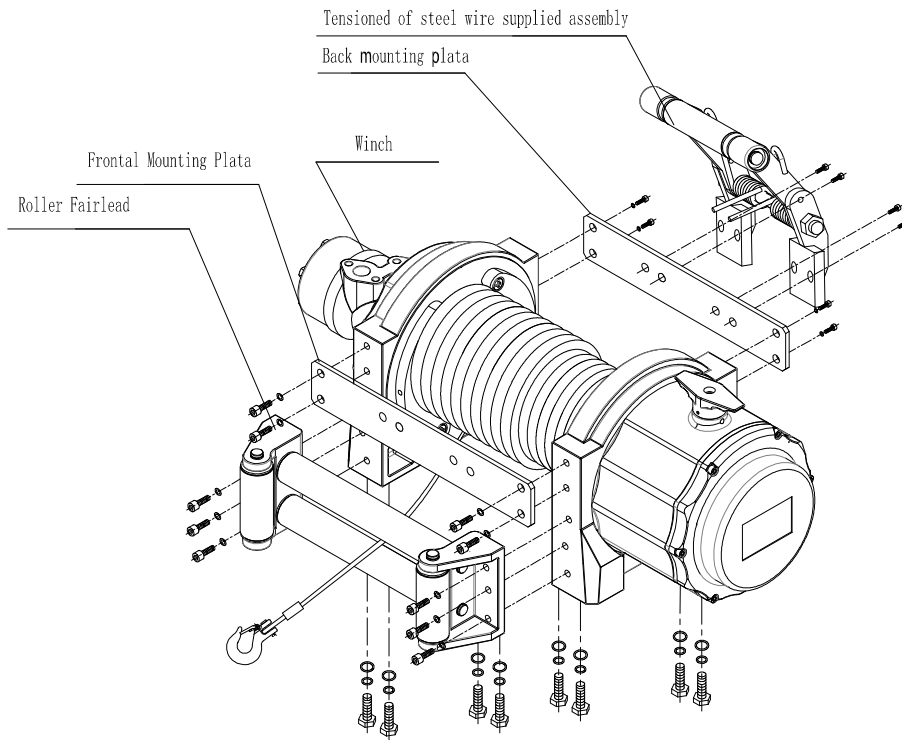

**! Caution:**

The hydraulic system needs a relief valve to ensure the system safety. The absence of such a valve could cause serious injury and damage the winch.

Winch battery cables should be placed so that there is a small amount of slack in the cable.

If you are using a heat exchanger with your application to cool the hydraulic fluid you should refer to the illustration about mounting.

You should check the hydraulic fluid level and replace any that may have seeped out. The hydraulic system should be purged at this time. Listed below are the directions on how to purge the hydraulic system.

- 1) Start the engine.
- 2) Power the winch to draw out about 5 feet of cable.
- 3) Shut down the engine.
- 4) Check the fluid level and fill as needed.
- 5) Repeat steps 1 through 4 as necessary.
- 6) Start the engine.
- 7) Move the cable into the desired position.
- 8) Turn the wheels on the vehicle from the right lock to the left lock positions five times to help bleed the hydraulic system.
- 9) If the hand control unit is working backwards, simple exchange the brown and the white wire connections within the valve.

Test the winch for proper operation. Refer to the section below.

## **OPERATION**

### **⚠ WARNING**

- 1 Make sure clutch is totally engaged before starting any winch operation;**
- 2 Stay clear and away from raised loads;**
- 3 Stay clear of cable while pulling do not try to guide cable;**
- 4 A min. of 5 wraps of cable around the drum barrel.**

### **General information:**

The Winch's standard equipments contain gear reducer、 drum、 hydraulic motor、 solenoid valve、 switch assembly、 female connector and plumbing fittings. The winch obtains its pressure from the vehicle's existing power steering pump or other hydraulic power. The winch is totally sealed, can be used underwater.

There are several other ways to supply power to the winch. The first way is to use an individual pump for engineering use. The second way is to provide the winch's hydraulic pressure is with the vehicle's exiting power steering pump (See Installation Instructions).

① Use a suitable individual pump, which doesn't have an oil pressure relief valve. It will supply pressure for both the steering box and the winch.

② Use a combined pump with an integrated oil valve. The oil valve will supply two kinds of flow based on the difference in demand. One type of flow will be constant and should be used with the steering system. The other will provide higher pressure and is for engineering use.

### **⚠ Caution:**

Hydraulic system needs an relief valve to make sure the system is safe; If there is not relief valve in the system; it would be serious danger and the system can't operation. If your winch drived by an existing hydraulic power system, the relief valve is also existing.

### **Winch working demonstration:**

1. Disengage the clutch by turning the clutch to the "CLUTCH OUT" position.
2. Grab the cable assembly and pull the cable to the desired length, then attach to item being pulled.

**Caution:** Always leave at least five turns of cable on the drum; Review Winch Safety Warnings and Precautions on page 2, 3 before continuing.

3. Reengage the clutch by turning the clutch assembly to the “CLUTCH IN” position as needed.
4. Test-run winch in both directions. Turn the winch in each direction for about one or two seconds meantime make the clutch totally engaged automatically.
5. While standing aside of the tow path, hold and operate the switch assembly supplied by your choice. Wait until the motor stops before reversing directions.

## **WINCH ACCESSORIES YOU WILL NEED**

### ***NOT INCLUDED WITH YOUR WINCH***

Gloves – For handling the wire rope and hook strap.

Anchor Strap/Chain – Tree saver anchor straps are made of high quality nylon with high tensile strengths up to 15000lbs.

Heavy Blanket – place on the cable to absorb energy should the wire rope break.

## **RIGGING TECHNIQUES**

### **Self-Recovery**

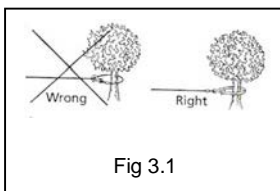

Locate a suitable anchor such as a strong tree trunk or boulder.

Always use a sling as an anchor point. **⚠ CAUTION** Do not attach the clevis hook back onto the cable as this could cause damage to the cable. As shown in Fig 3.1

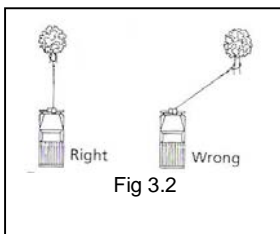

**⚠ CAUTION** Do not winch from an acute angle as the wire rope will pile up on one side of the drum causing damage to wire rope and the winch. Fig 3.2

Short pulls from an angle can be used to straighten the vehicle. Long pulls should be done with the wire rope at a 90° angle to the winch/vehicle.

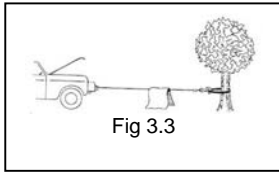

When pulling a heavy load, place a blanket or jacket over the wire rope five or six feet from the hook. In the event of a broken cable it will dampen the snap back. For additional protection open the hood of the vehicle as shown in Fig 3.3

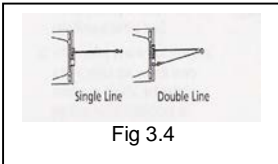

For pulls over 70% rated line pull, we recommend the use of the snatch block/pulley block to double line the wire rope. Fig 3.4

This reduces the load on the winch and the strain on the rope by up to 50% depending on the included angle.

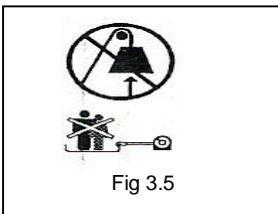

**WARNING** - Never use your winch for overhead hoisting or for lifting people or moving people.

## **LUBRICATION**

1. All moving parts within the Winch having been Lubricated using high temperature lithium grease at the factory. No internal lubrication is required.
2. Lubricate Cable Assembly periodically using a light penetrating oil.

## **CABLE ASSEMBLY REPLACEMENT**

If the wire rope has become worn or is beginning to show signs of strands breaking, it must be replaced before being used again.

1. Turning clutch to the "CLUTCH OUT" position.
2. Extend cable assembly to its full length. Note how the existing cable is connected to the drum.
3. Remove old cable assembly and attach new one as the old cable connected to the drum. Insert the end of the new rope and secure the screw being tightly screwed
4. Turning clutch to the "CLUTCH IN" position.
5. Retract cable assembly onto drum, first five wraps being careful not to allow kinking, then winch cable must be wound onto the drum under a load of at least 10% rated line pull.

 **WARNING** - Only replace the wire rope with the identical replacement part recommended by the manufacturer.

### **TROUBLE SHOOTING**

<b>SYMPTOM</b>	<b>POSSIBLE CAUSE</b>	<b>SUGGESTED ACTION</b>
Winch does not turn .	<ul style="list-style-type: none"> <li>-Insufficiently hydraulic system pressure.</li> <li>-Improper connections of hydraulic system, no oil into motor.</li> </ul>	<ul style="list-style-type: none"> <li>-Check relief valve regulate pressure.</li> <li>-Check all the plumbing fixtures according to the working principle chart.</li> <li>-Defective directional control valve.</li> </ul>
Motor runs but Cable drum does not turn	<ul style="list-style-type: none"> <li>- The clutch is Not engaged</li> </ul>	<ul style="list-style-type: none"> <li>-Turn the clutch to the high or lows peed position. If problem still persists, a qualified technician needed to check and repair.</li> </ul>
Winch drum runs slowly or without normal power.	<ul style="list-style-type: none"> <li>-Insufficient pressure or oil flow</li> <li>-Insufficient fluid in the system</li> <li>- Wrong winch working direction.</li> </ul>	<ul style="list-style-type: none"> <li>-Bump is not suitable or defective. Change a new one or a suitable one</li> <li>-Check fluid level. Add fluid until full.</li> <li>-Change the connection of balance valve and motor.</li> </ul>
Winch cannot spool off wire rope with load smoothly.	<ul style="list-style-type: none"> <li>-Wrong winch working direction.</li> </ul>	<ul style="list-style-type: none"> <li>-Change the connection of balance valve and motor.</li> </ul>

# WINCH ASSEMBLY DRAWING 10000NW

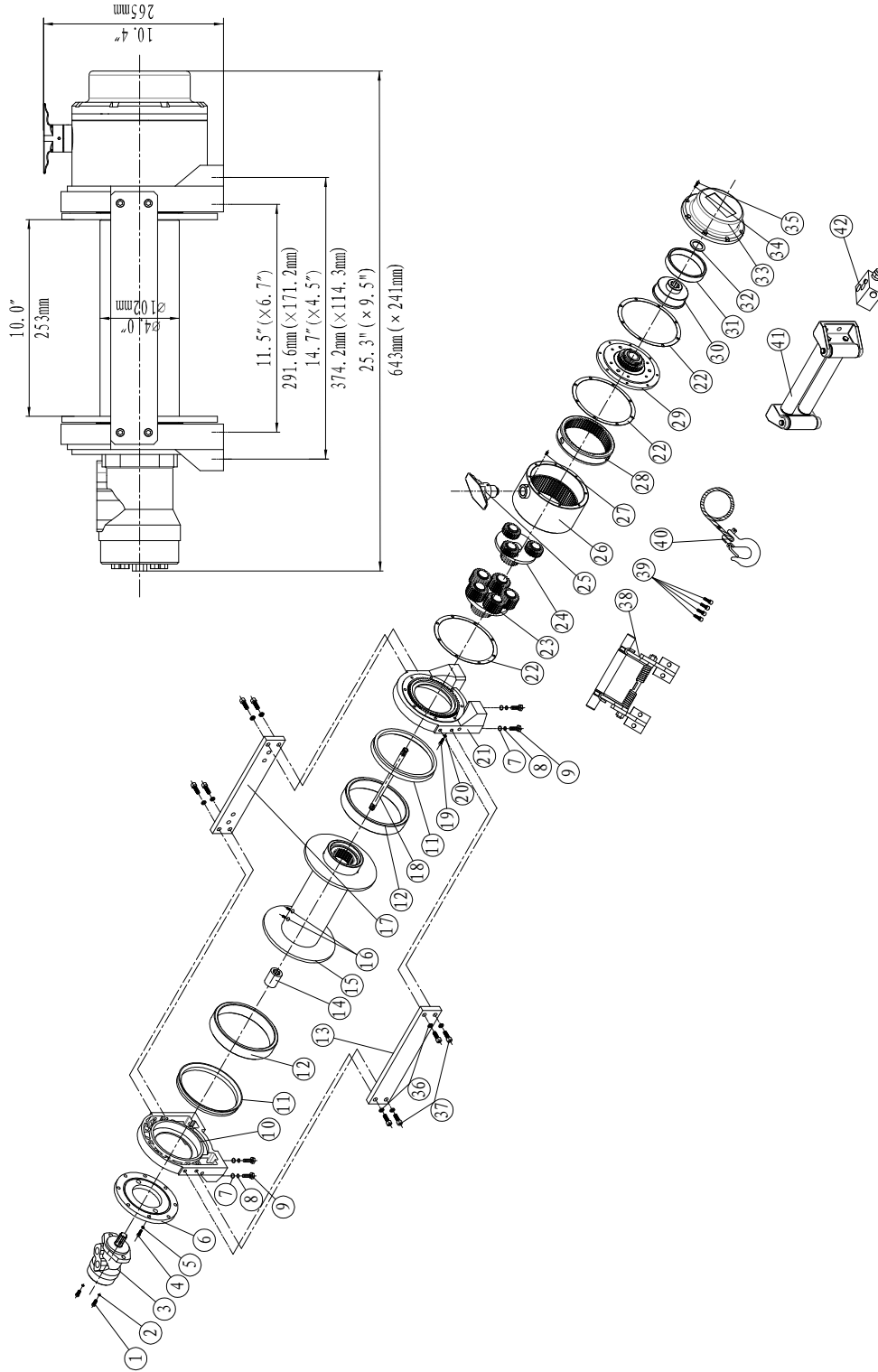

## WINCH PARTS LIST 10000NW

No.	Part #	Qty	Description	Remark
1	HE1000001	2	Screw M12 x 30	
2	HE1000002	2	Lock Washer Φ12	
3	HE1000100	1	Hydraulic Motor	
4	HE1000003	8	Screw M8 x 20	
5	HE1000004	8	Lock Washer Φ8	
6	HE1000005	1	Coupling plate	
7	HE1000006	8	Thin Flat Washer Φ10	
8	HE1000007	8	Lock Washer Φ10	
9	HE1000008	8	Cap Screw M10 x 35	
10	HE1000009	1	Front Bearing	
11	HE1000010	2	Ring Seals	
12	HE1000011	2	Axle Bush	
13	HE1000012	1	Frontal Mounting Plate	By choice
14	HE1000013	1	Coupling I	
15	HE1000200	1	Drum Assembly	
16	HE1000014	2	Screw M8 x 10	
17	HE1000015	1	Back Mounting Plate	
18	HE1000016	1	Transmission Shaft	
19	HE1000017	8	Screw M6 x 25	
20	HE1000018	8	Lock Washer Φ6	
21	HE1000019	1	End Bearing	
22	HE1000020	3	Gasket	
23	HE1000300	1	Gear Carrier Assembly (Intermediate)	
24	HE1000400	1	Gear Carrier Assembly (Input)	
25	HE1000500	1	Clutch Assembly	
26	HE1000600	1	Cam Gear	
27	HE1000021	1	Screw M5 x 8	
28	HE1000022	1	Gear-Ring (Input)	
29	HE1000700	1	Break / Shaft Assembly	
30	HE1000023	1	Coupling II	
31	HE1000800	1	Bearing	
32	HE1000024	1	Trust Washer (Input)	
33	HE1000025	1	Cover-Gear Housing	
34	HE1000026	8	Lock Washer Φ5	
35	HE1000027	8	Screw M5 x 30	
36	HE1000007	8	Lock Washer Φ10	
37	HE1000028	8	Screw M10 x 20	
38	HE1000900	1	Tensioned Of Steel Wire Supplied Assembly	
39	HE1000029	4	Screw M10 x 25	
40	HE1001000	1	Cable Assembly	
41	HE1001100	1	Roller Fairlead	By choice
42	HE1001100	1	Balanced Valve	

# WINCH ASSEMBLY DRAWING 15000NW

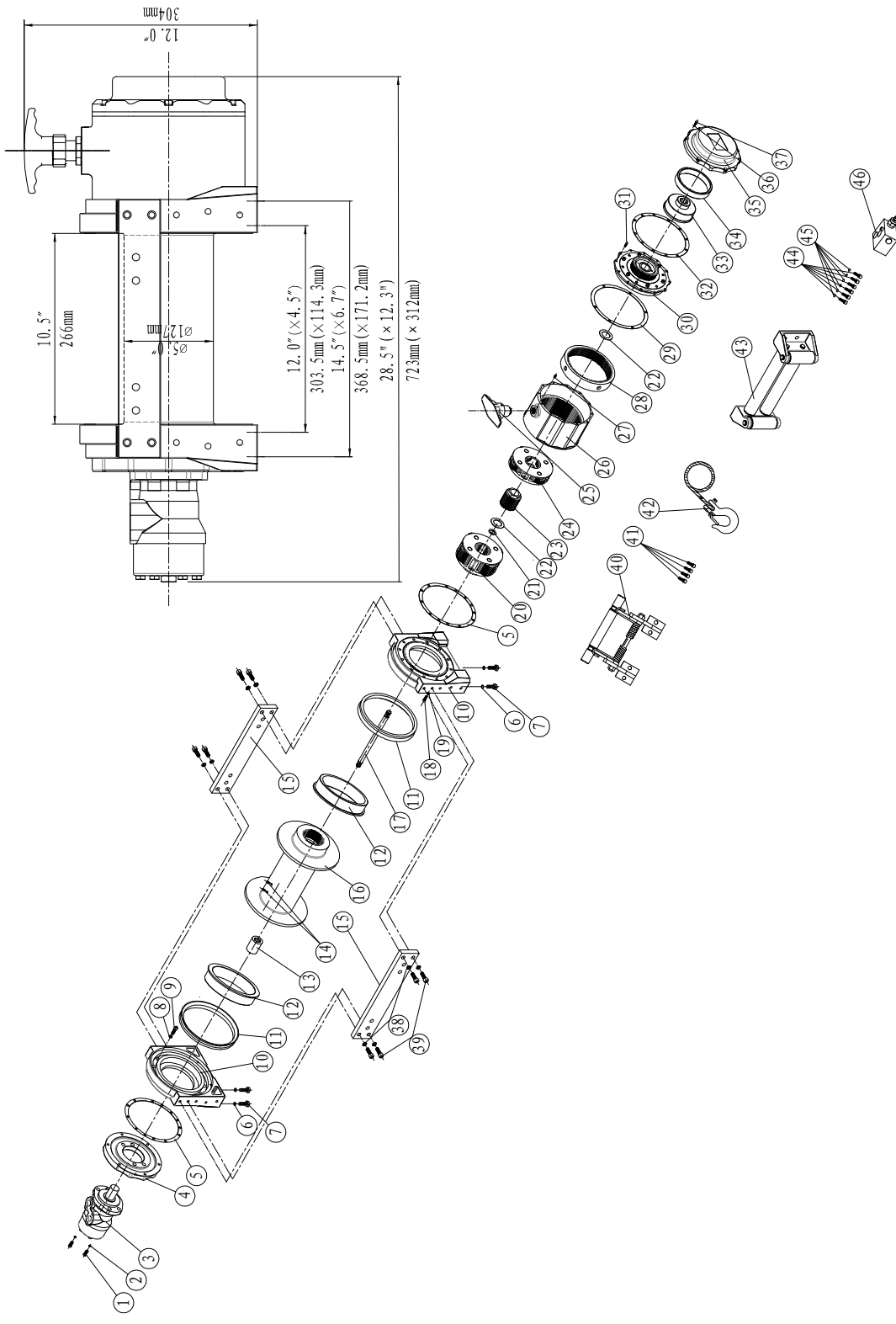



## WINCH PARTS LIST 15000NW

No.	Part #	Qty	Description	Remark
1	HE1500001	8	Screw M12 x 35	
2	HE1500002	8	Lock Washer Φ12	
3	HE1500100	1	Hydraulic Motor	
4	HE1500003	1	Coupling plate	
5	HE1500004	2	Gasket I	
6	HE1500005	4	Lock Washer Φ12	
7	HE1500006	4	Cap Screw M12 x 30	
8	HE1500007	6	Lock Washer Φ8	
9	HE1500008	6	Screw M8 x 25	
10	HE1500009	2	Front Bearing	
11	HE1500010	2	Ring Seals	
12	HE1500011	2	Bushing—Drum	
13	HE1500012	1	Coupling I	
14	HE1500013	2	Screw M8 x 15	
15	HE1500014	2	Mounting Plata	
16	HE1500200	1	Drum Assembly	
17	HE1500015	1	Transmission Shaft	
18	HE1500016	12	Screw M8 x 30	
19	HE1500017	12	Lock Washer Φ8	
20	HE1500300	1	Gear Carrier Assembly (Intermediate)	
21	HE1500018	1	Trust Washer II	
22	HE1500019	2	Trust Washer I	
23	HE1500020	1	Gear—Intermediate Sun	
24	HE1500400	1	Gear Carrier Assembly (Input)	
25	HE1500500	1	Clutch Assembly	
26	HE1500021	1	Cam Gear	
27	HE1500022	1	Screw M6 x 15	
28	HE1500023	1	Gear-Ring (Input)	
29	HE1500024	1	GasketIII	
30	HE1500600	1	Break / Shaft Assembly	
31	HE1500025	6	Scre w M4 x 15	
32	HE1500026	1	Gasket II	
33	HE1500027	1	Coupling II	
34	HE1500700	1	Bearing	
35	HE1500028	1	Cover-Gear Housing	
36	HE1500029	6	Lock Washer Φ6	
37	HE1500030	6	Screw M6 x 30	
38	HE1500031	8	Lock Washer Φ10	
39	HE1500032	8	Screw M10 x 30	
40	HE1500800	1	Tensioned Of Steel Wire Supplied Assembly	
41	HE1500033	4	Screw M10 x 25	
42	HE1500900	1	Cable Assembly	
43	HE1501000	1	Roller Fairlead	
44	HE1500034	6	Screw M10 x 30	
45	HE1500031	6	Lock Washer Φ10	
46	HE1501100	1	Balanced Valve	

## **SPECIFICATION(10000NW)**

Rated line pull	10000 lbs (4536 kgs)
Motor displacement	100.8ml/r
Oil flow	5~60L/min
Pressure	15Mpa
Gear reduction ratio	16:1
Cable (Dia. × L)	Ø13/32" × 86.9' (Ø10.2mm × 26.5m)
Drum size(Dia. × L)	Ø4.0 " × 10.0" (Ø102mm × 253mm)
Mounting bolt pattern	14.7 " × 4.5 " (374.2mm × 114.3mm) ; 11.5 " × 6.7" (291.6mm × 171.2mm) 8-M10
Overall dimensions (L × W × H)	25.3" × 9.5" × 10.4" 643mm × 241mm × 265mm
Net weight lbs(kg)	143 65

### **Pull , Speed, Pressure, Flow (First layer)**

Line pull lbs (kgs)	Pressure Mpa(Psi)	Flow G/min (L/min)	Line speed ft/min(m/min)
0	2.0(290.1)	1.3(5)	3.0(0.9)
4000(1814)	5.6(812.3)	2.6(10)	5.9(1.8)
6000(2722)	9.4(1363.5)	5.2(20)	11.8 (3.6)
8000(3629)	12.2(1769.6)	10.4(40)	23.6(7.2)
10000(4536)	14.8(2146.7)	15.6(60)	36.7(11.2)

### **Line Pull And Rope Capacity Inlayer**

Layer of wire rope	Rated line pull lbs(kgs)	Total rope on drum ft (m)
1	10000(4536)	23.0(7.0)
2	7355(3336)	49.2(15.0)
3	6780(3075)	78.7(24.0)
4	5711(2591)	86.9(26.5)

### **SPECIFICATION(15000NW)**

Rated line pull	15000 lbs (6810kgs)
Motor displacement	160ml/r
Oil flow	5~60L/min
Pressure	16Mpa
Gear reduction ratio	17.2:1
Cable (Dia. × L)	Ø15/32" × 86.9 ' (Ø12mm × 26.5m)
Drum size(Dia. × L)	Ø5.0 " × 10.5" (Ø127mm × 266mm)
Mounting bolt pattern	12.0 " × 4.5 " (303.5mm × 114.3mm) ; 14.5 " × 6.7" (368.5mm × 171.2mm) 8-M12
Overall dimensions (L × W × H)	28.5" × 12.3" × 12.0" 723mm × 312mm × 304mm
Net weight lbs(kg)	227lbs(103kg)

#### **Pull , Speed, Pressure, Flow (First layer)**

Line pull lbs (kgs)	Pressure Mpa(Psi)	Flow G/min (L/min)	Line speed ft/min(m/min)
0	2.0(290)	2.6(10)	4.2(1.3)
4000(1814)	4.6(668)	5.3(20)	8.5(2.6)
6000(2722)	6.9(1003)	7.9 (30)	12.4(3.8)
8000(3629)	9.2(1337)	10.6(40)	16.7(5.1)
10000(4536)	11.5(1672)	13.2(50)	21(6.4)
12000(5448)	14.0(2030)	/	/
15000(6810)	17.5(2537)	/	/

#### **Line Pull And Rope Capacity Inlayer**

Layer of wire rope	Rated line pull lbs(kgs)	Total rope on drum ft (m)
1	15000(6810)	29.5(9.0)
2	12791(5807)	65.6(20.0)
3	11150 (5062)	86.9(26.5)

Limited lifetime with 3 year on electrical

Limited Lifetime Warranty for WARRIOR WINCHES

Winch solutions are the sole distributors of WARRIOR WINCHES.

Winch solutions ("seller" or winch solutions) warrants to the original retail buyer only ("Buyer") that any mechanical component of a genuine WARRIOR WINCH ("product") is free of defects in material and workmanship for the lifetime of the winch.

The electrical components (including the motor, contactor, and switches) will be free of defects in material and workmanship for a period of (3) three years (36 Months) from the original purchase provable date of purchase.

Any Product Winch solutions determines to be defective will be repaired or replaced at Winch solutions sole discretion without charge to the Buyer upon Buyer's compliance with this procedure. Seller or its Authorized Agent may make reasonable charges for parts and for labour for repairs not covered by this Lifetime Limited Warranty. The warranties set forth herein are exclusive and in lieu of all other warranties, whether oral or written, express or implied.

**All purchases must be registered. Any product that has not been registered will be covered by the standard 1 year warranty.**

To obtain service under this warranty, the Buyer shall mail, ship or otherwise deliver to the address noted below, at the Buyers expense; (1) the Product, (2) a written description of the problem, (3) Buyers name, address and contact number, (4) copy of the original purchase receipt.

The Warranty does not cover the cost of labour or transportation/shipping charges for the replacement or installation of defective parts.

This warranty does not apply to defects of the Product caused by; (1) normal wear and tear, (2) failure to comply with any installation or maintenance instructions provided by the Seller, including but not limited to subjecting the product to loads in excess of the loads listed in any instructions, Owners Manual or as detailed upon the Sellers website, (3) commercial or industrial use, (4) alteration or modification by any parties other than the Seller, (5) misuse, abuse, neglect, accidents, Acts of God, terrorism or (6) other causes beyond the control of the Seller after delivery of the Product to the Sellers Authorized Agent.

This Warranty does not cover cables, synthetic ropes, fairleads or exterior finishes

Winch solutions shall not be responsible or liable for any indirect or consequential damages. These consequential damages may include, but are not limited to, lost profits or loss of use and down time.

A winch solution reserves the right to change the Product design without notice. A winch solution reserves the right to replace any part or whole unit with a newer design of the same function.

**Please ensure you record the information below:**

<b>Distributor</b>	
<b>Date of Purchase</b>	
<b>Invoice No</b>	
<b>Serial No</b>	

**Please register your Winch at [www.warriorwinch.co.uk](http://www.warriorwinch.co.uk) , any product that is not registered will not be covered by the lifetime warranty.**

**In the unlikely event you experience problems, contact the distributor with this information.**