

INSTALLATION SHEET

RUGGED LINER

REAR INNER WHEEL WELL LINERS 2021+ FORD RAPTOR

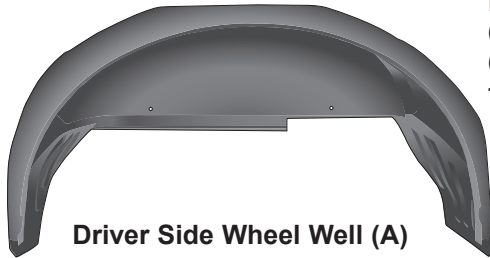

Driver Side Wheel Well (A)

LIST OF CONTENTS:

- (A) 1 - Driver Side Wheel Well
- (B) 1 - Passenger Side Wheel Well

LIK81 KIT:

(C) 4 - J-Clips

(D) 4 - Screws

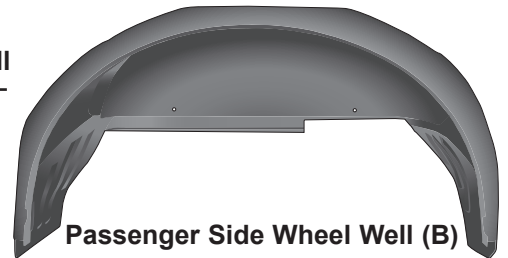

Passenger Side Wheel Well (B)

MISSING PARTS???

Call Rugged Liner at

800-433-3604

Any required parts will be shipped to you directly.
(DO NOT return whole kit to store)

TOOLS REQUIRED:

- Ratchet using 7mm socket in step 4.
- Ratchet using 10mm socket in step 7.

1

PLEASE READ INSTRUCTIONS CAREFULLY BEFORE STARTING THE INSTALLATION.
One person can perform the installation.



2

VEHICLE PREPARATION:

It is important that all areas where the wheel wells mount are clean and free of debris prior to installing.



3

For Trucks with Mud Flaps: Remove mud flaps before installing wheel well liners. Then follow steps 4-7. Re-install mud flaps.

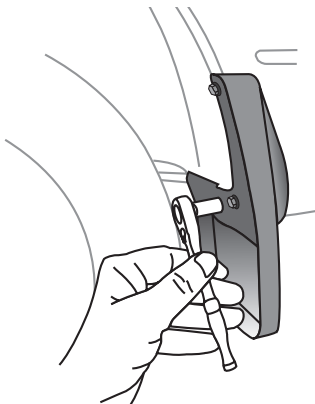

4

Start on the driver side using a ratchet with 7mm socket to remove the (8) fasteners around the factory flare opening (**Save the fasteners**).

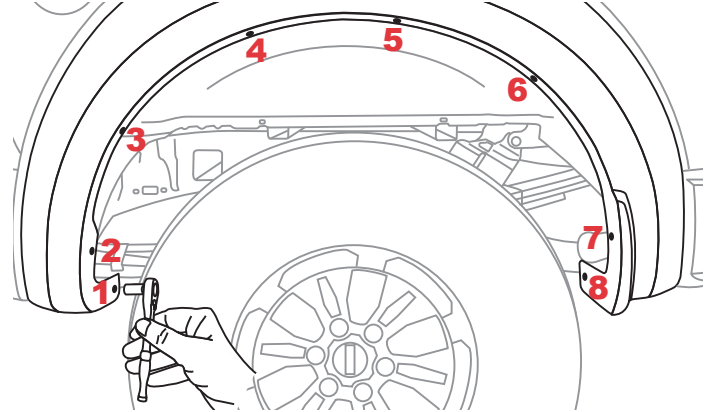

5

Locate the two holes at the back area of the wheel housing and insert one J-Clip (C) in each hole **1 & 2**.

Shows Orientation of J-Clips Facing Cab

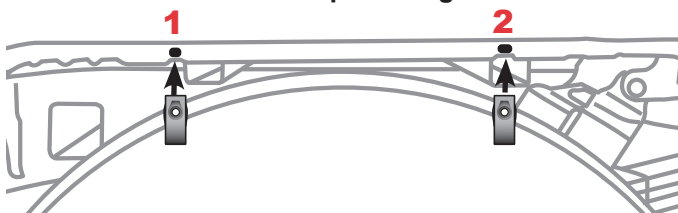

J-Clips Installed

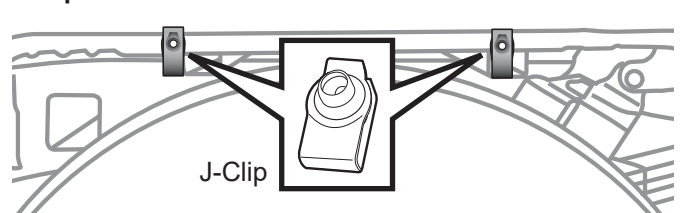

J-Clip

INSTALLATION SHEET

RUGGED LINER

2021+ FORD RAPTOR

6 Start on the driver side by setting the driver side wheel well (A) marked as (DS) inside the inner panel of the truck's wheel well behind the tire.

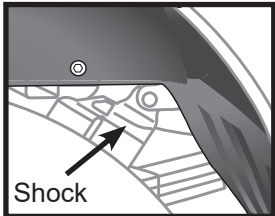

NOTE: Make sure the wheel well is inserted behind the shock.

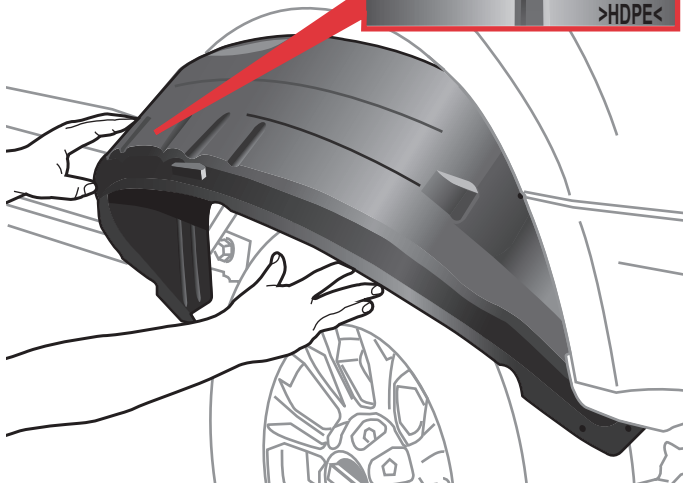

7 Tuck the bottom sides of the lower part of the wheel well liner behind the metal lip of truck's fender and then tuck the upper part. Then install two screws (D) provided in places **9** & **10** using a ratchet with 10mm socket. After that re-install the eight fasteners saved in step 4 in places **1-8** using a ratchet with 8mm socket.

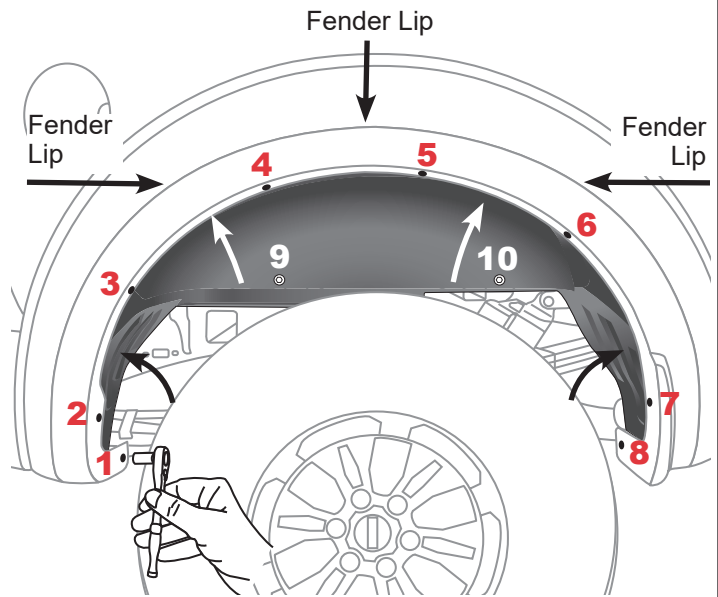

8 Repeat steps 3-7 on the passenger side when installing the passenger side wheel well (B).