











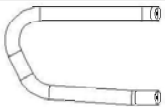









INSTALLATION INSTRUCTION
 13-17 HONDA LOWER FRONT FENCE
 ITEM NO: 13-17-013-02-A11V1

ATTENTION

1. Please read this installation instruction before installing this part.
 When install it, please pay attention to protecting your vehicles.

2. When you use it, please check this parts at a fix time-lapse, such as one month or two month.

PARTS LIST

No	Name /Qty	Photo	No	Name/Qty	Photo
1	Side bend 2 lateral symmetry		11	Flat washer 16 M10	
2	Top bend 1		12	Hex Bolt 14 M10x25	
3	Middle tube 1		13	Lock washer 16 M10	
4	Sand baffle plate 1		14	Nut 4 M10	
5	Sub plate 2 lateral symmetry		15	1 Hex Bolt 2 M10x40 (70x20x4.5)	
6	Corner code 2 lateral symmetry		16	Cylinder 2 φ20xφ11x17	
7	Reinforcement 2 lateral symmetry		17	Flat washer 4 M12	
8	Flat washer 2 M8		18	Hex Bolt 4 M12x30	
9	Hex Bolt 2 M8x40		19	Lock washer 4 M12	
10	Lock washer 2 M8		20	Nut 4 M12	

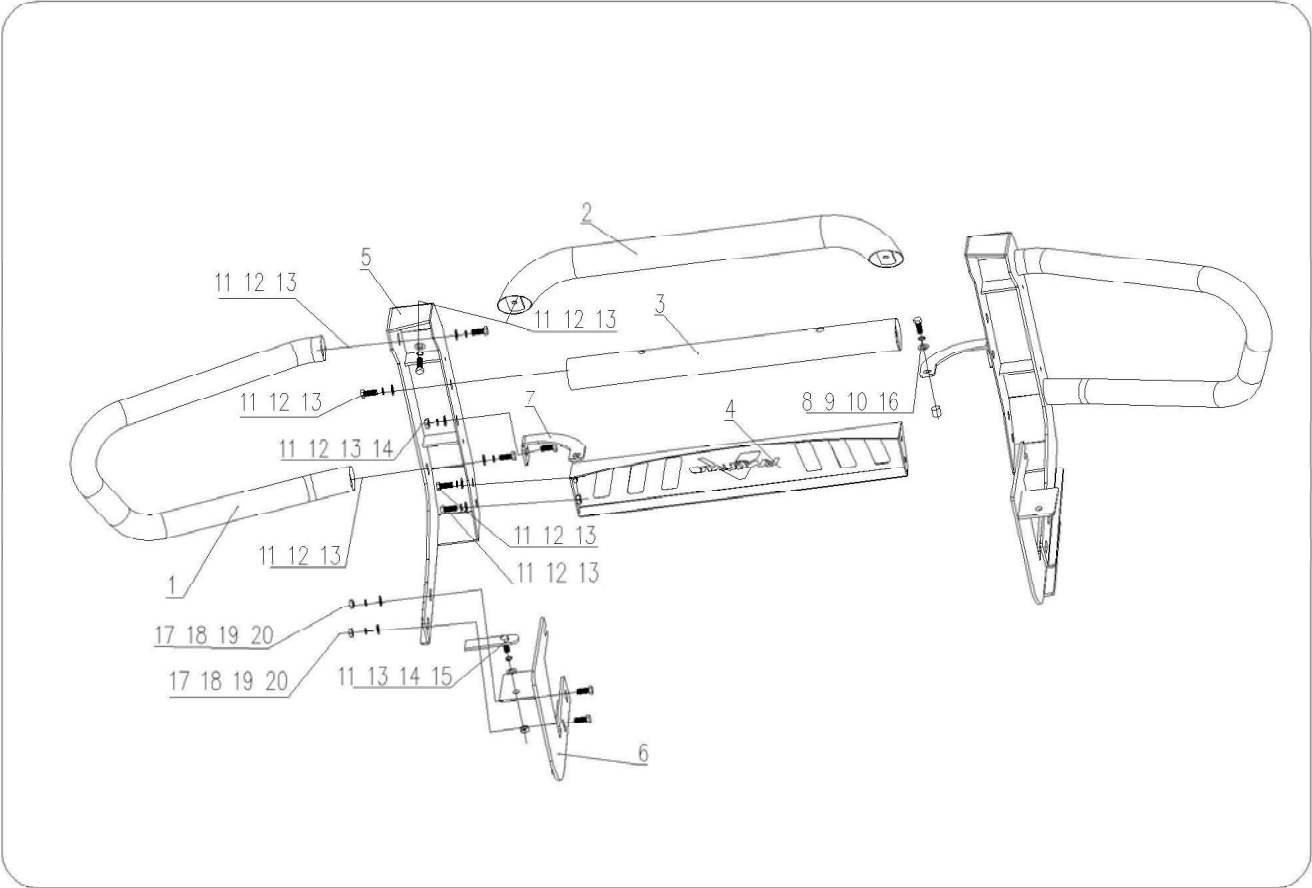

The original screw

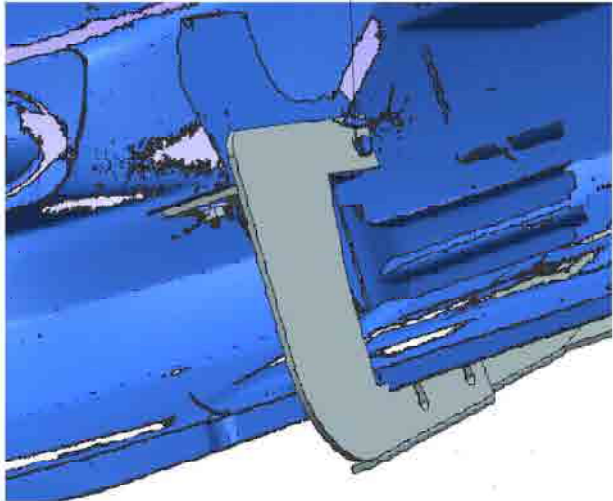
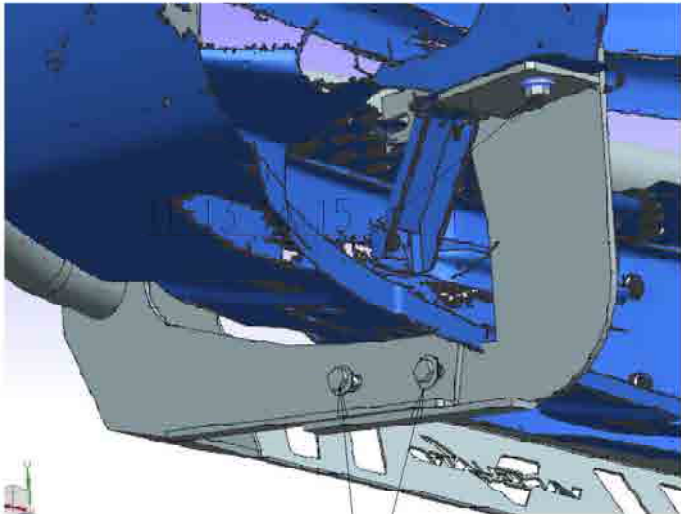

17 18 19 20

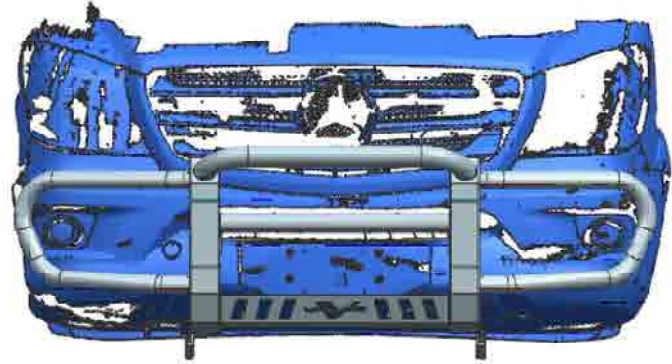
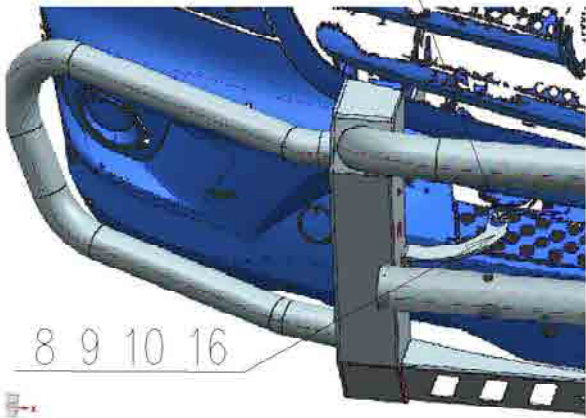
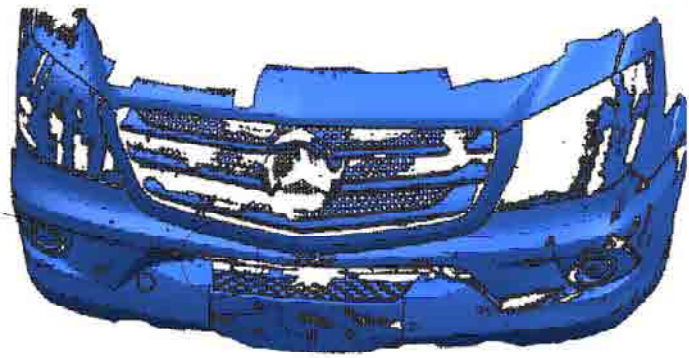

STEP 1: Check the parts in the box carefully if match above parts list .

STEP 2: Pls prepare the tools for installation, follow as: 12-14wrench, 17-19wrench.

STEP 3: Put the mount bracket c into the girder of the car, and tighten it with H.

STEP 4: Put the mount bracket a on the head of the car and then tighten it with E.

STEP 6: Install the grille guard A on the mount c and tighten it with I

STEP 7: Test and make sure that the grille guard is steadily fixed.

STEP 8: Installation is finished.











