

PLEASE READ BEFORE INSTALLATION



SIX SHOOTER

Wireless Control System



Quick Start Instructions

PLEASE NOTE: Proper installation and wiring techniques are required to ensure no damage is caused to the Trigger system or the vehicle it is being installed into. The warranty is voided if not installed per the instructions and using appropriate methods for automotive wiring. We recommend professional installation of this product.

Features

Control module:

- 6 channels, 2 x 30 amp circuits, 2 x 10 amp circuits, 2 x 5 amp circuits, All Solid State, 12-24 volt.
- RF Remote switch pad usable inside or outside the vehicle.
- Bluetooth control from phone/tablet app .
- Manual buttons for on/off on top of case.
- DIN connector built in for manual control with conventional toggle switches (harness sold separately).
- Low voltage cutout to shut down Trigger if battery voltage gets low.
- 100 amp fuse installed on positive input wire for protection.
- 12 to 24 volt out with waterproof connectors.
- Fuse's built in, waterproof cover (30 amp - 1 and 2, 10 amp - 3 and 4, 5 amp - 5 and 6)
- LED's to indicate relay on and if fuse is blown, blue for circuit on, red for blown fuse.
- Waterproof case design, withstands temps to 250 deg. F and below freezing.
- 12 to 24 volt input, 3 wires, ground, switched positive, battery positive.

RF Remote:

- 2.4 ghz frequency hopping RF connection to control box.
- Replaceable battery power and/or 12 volt hardwired option for backlit switches .
- Back lit with press of button, delayed off for the back light. If hardwired, provides a color changing option adjustable from App. Back lights stay lit when vehicle lights are on.
- Custom switch labels included.
- Weatherproof design.

App Control:

- Apps for both Android and iOS with simple interface for turning on and off the 6 channels. Allows customized names for each channel and has momentary option as well.
- Battery voltage shows in App screen.
- Controls backlight color in the RF switch pad.
- App allows for dimming and strobe functions in addition to ON/OFF.

Harnesses:

- Kit includes six 8' wire harnesses with the mating connector to the control box on one end and blank wires on the other. Two 12 gauge, two 14 gauge, two 18 gauge.
- Harnesses include sturdy vinyl shroud.

CONTROL MODULE INSTALLATION:

1) Mount the control module as close to the battery as possible. Use the mounting tabs on the body to securely install the module. NOTE: If extending the input wires, be sure to use wires of equivalent or greater gauge to the ones on the module.

2) Use the included solderless terminals to connect the main input wires (black -, and red +) to the battery.

3) You can choose to connect the small gauge power wire (yellow) to an ignition activated circuit, to a dash mounted switch or to the parking lamp circuit of your vehicle. We do not recommend connecting directly to the battery. If it is connected directly, the trigger system will always be on and does draw a very small amount of power from the battery. It will also be searching constantly for a signal on both the RF and Bluetooth circuits.

4) Install powered accessories and use the included harnesses to connect to the main module with the waterproof connectors. NOTE: Be sure to use the correct gauge wiring harness for the circuit you are using. 1 and 2 are the higher amperage circuits at 30 amps each and should use the 12 gauge (larger) harnesses. 3, 4 are 10 amp, 5 and 6 are 5 amp and should use the 14 gauge (smaller) harnesses.

NOTE: Do not exceed the amperage recommendations stated on the unit or here, this may cause the unit to fail and will void the warranty.

RF Remote Battery Installation

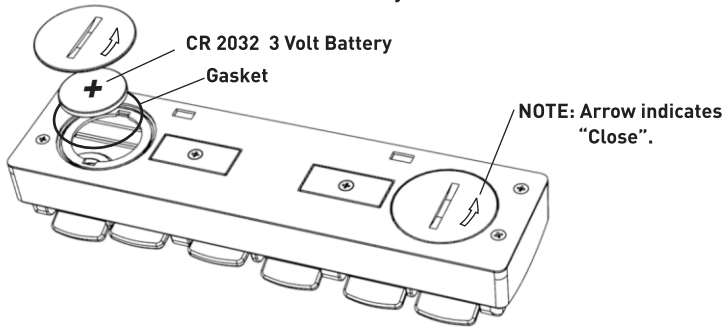

Install the Cr2032 batteries as shown. Be sure to turn the battery door to the right (clockwise) to open, the arrows indicate the direction to close (counter clockwise).

NOTE: Be careful not to lose the gasket when changing/installing batteries. It is important to be sure the remote is waterproof.

IOS and Android App Installation

Please go to the Apple App store or the Google Play store to download the free Apps. Search for "Trigger ACS" to find the App. Download and install then follow the instructions in the App to connect to the Trigger 6 Shooter Control Module.

The App will allow changes to the color of the back light and switch illumination. It also provides a voltage indicator for the battery the Trigger is connected to.

Detailed instructions on connection and usage are built into the App or go to www.triggercontroller.com for detailed videos and instructions on the use of the App with your Trigger.



Accessories

DIN Accessory Port:

The Trigger 6 Shooter has a DIN Port for controlling functions with conventional toggle switches. The DIN cable and toggles are sold separately. Instructions for wiring are included with the DIN cable and are available on the triggercontroller.com website.

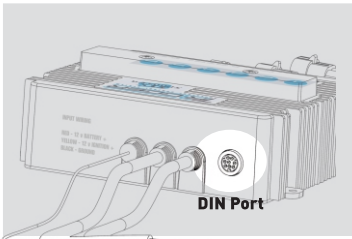

Toggle Switch Removal/Replacement:

The Trigger 6 Shooter RF Remote has removable/replacable toggles. Simply insert a small blade screwdriver on either side of the toggle (A) and apply light pressure sideways to release the round tab on the toggle (B) on one side. Now pull up on the side that has been released. NOTE: A momentary toggle switch can be swapped for the standard toggle.

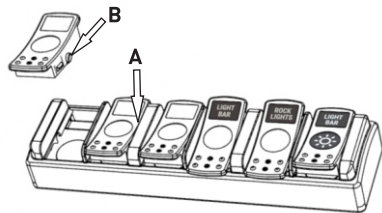

WARRANTY

The Trigger system is covered for 3 years against manufacturing defects. Please see the website at www.aacbrands.com for additional details and to arrange an RMA. Please contact our customer service before returning or with any questions at 951-339-1469.

RF Remote Mounting Options

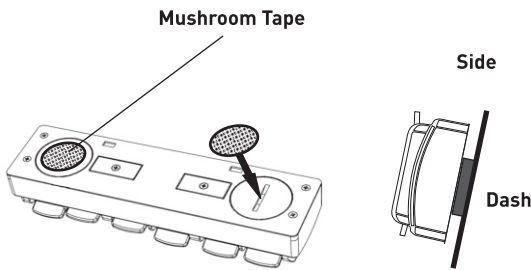
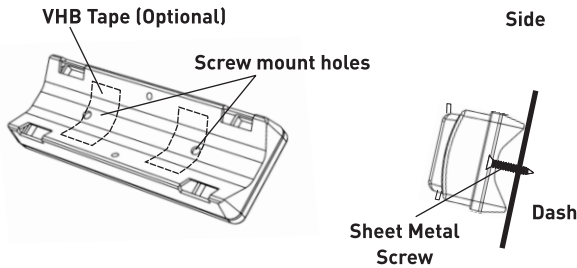
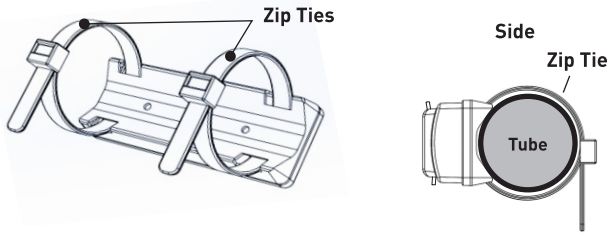

RF to Control Module Binding Process:

Your Trigger 6 Shooter RF comes bound from the factory, these instructions will be for binding a replacement remote or if something happens and the remote no longer communicates with the control module.

- 1) Be sure the RF remote is wired to 12 volt power (Binding will not function on battery only). If not using the 12 volt cable for the remote, connect it temporarily to a 12 volt battery source to bind RF and control module as needed.
- 2) On the control module, hold down the 1 and 6 keys at the same time until channel 6 LED is on solid. The channel 6 light will light on the RF remote when the control module has connected. Then we can move to the next step.
- 3) Set binding code: Press 1 or 6 on RF randomly between 4 and 20 digits, then press 3 or 4 on and off. The light for channel 6 will turn off. (NOTE: The code is not important to remember unless you want two 6 Shooters to be controlled by the same remote.)

Included:

- 1 x Console (A)
- 1 x Metal mount (B)
- 2 x Slide mount (C)
- 2 x 3 mm - 10 mm Pan screw (D)
- 2 x 3 mm - 15 mm Flush screw (E)

Please Note: Remote, Mounting base, and power cable sold separately.

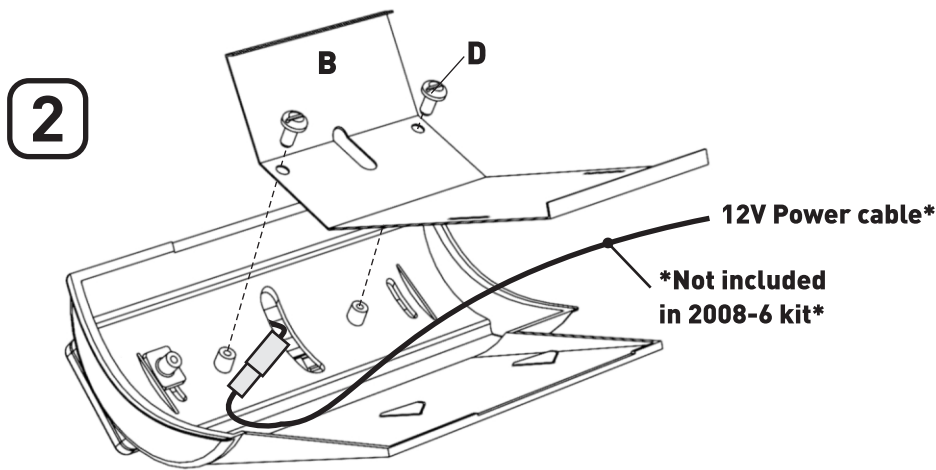
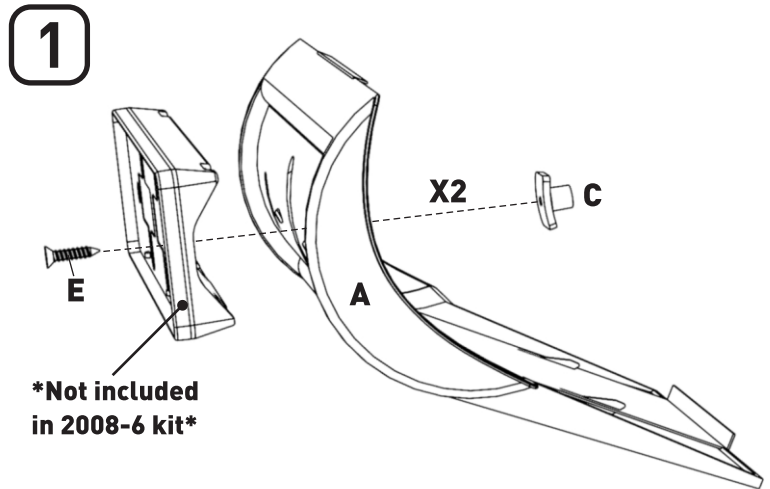

*Choose best route for 12v wire based on your vehicle.

Installation

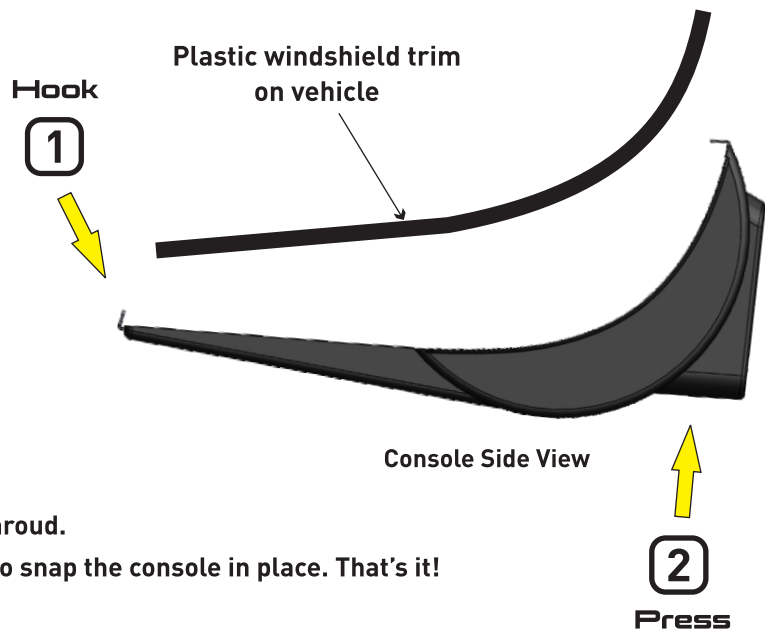

(1) Hook the rear tabs on the plastic windshield shroud.

(2) Press the front where indicated in the picture to snap the console in place. That's it!

Good job.



Part # 2011 JK Fender Mount 2013 - 17

Included:
Aluminum Trigger Mount ("L").
Wing Bolt
4x Mounting Screws/nuts



Installation:

- 1) Use the 4 included screws and nuts to attach the Trigger controller to the bracket.
- 2) Remove inner fender bolt shown at "A".
- 3) Slide Trigger/mount assy into the area next to the battery as shown below.
- 4) Use included Wing bolt to attach the Controller assy to the fender inner where the factory bolt was removed.

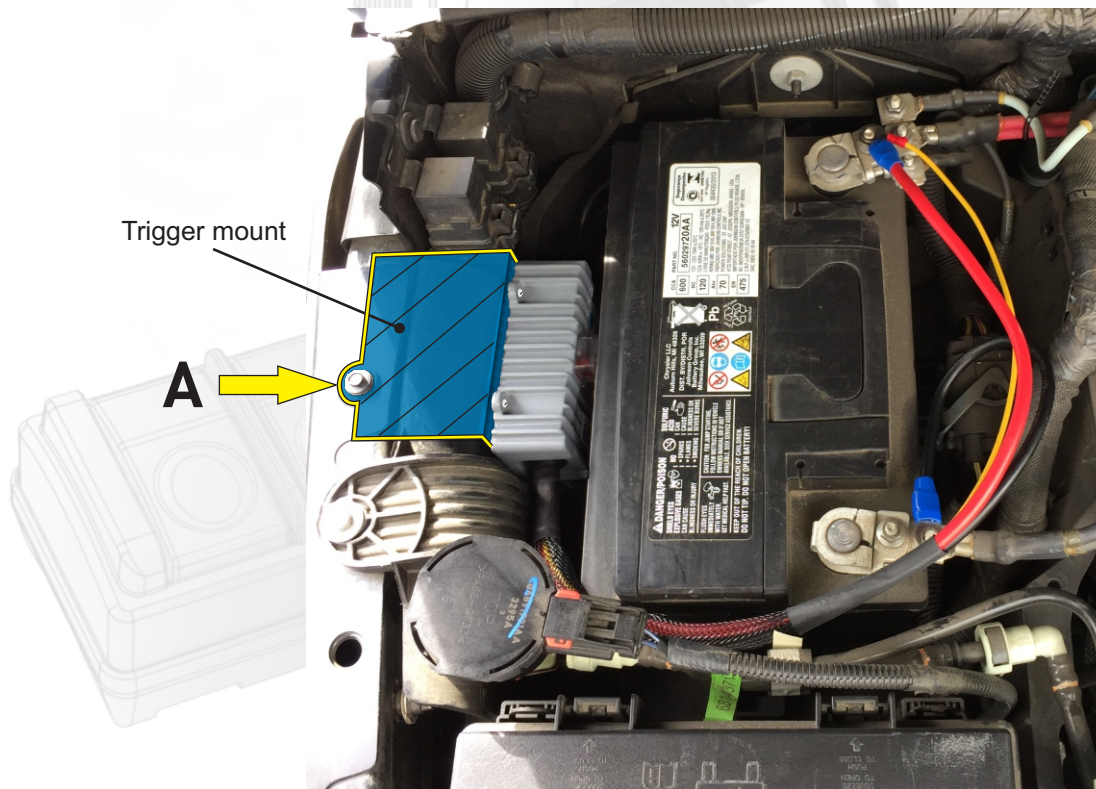

NOTE: Route wires as required depending on installation requirements.

NOTE: Use Wing Bolt to quickly remove assembly as needed to check fuses and/or circuits.

TRIGGER



TECH BULLETIN

Wiring the RF remote for 12 volt power

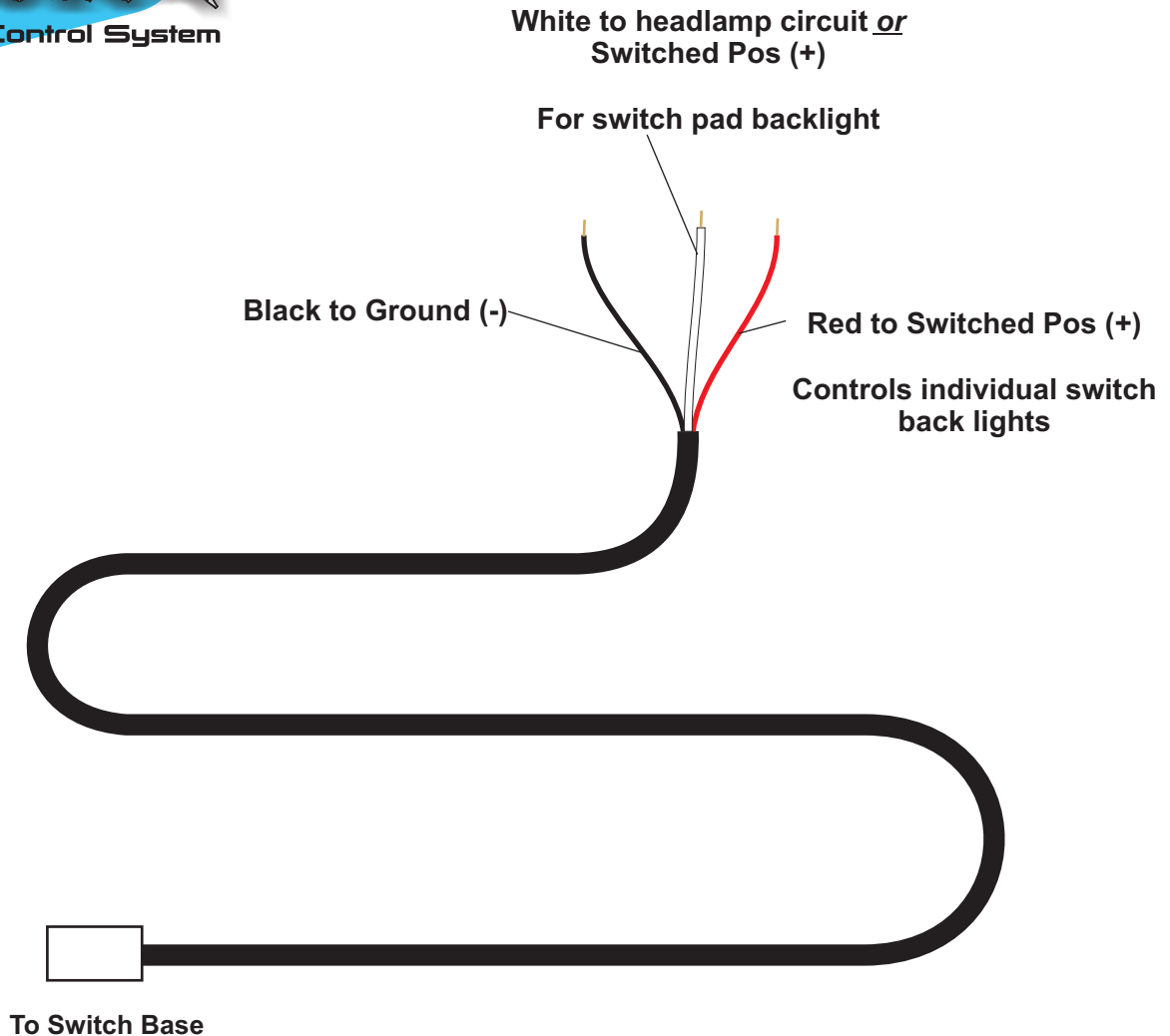

Wiring for the back lighting on the RF switch pad includes 3 wires for connection. The RED is used to back light the individual switches when they are turned on and should be connected to switched ignition.

The WHITE wire is for the backlighting behind the switches and can be connected to the headlamp circuit OR to the same place as the red wire (switched ignition). This allows the backlighting to come on only when the headlights are on.

The black wire is for ground.

www.triggercontroller.com