

Installation Instruction

Part#: IB26DJF3A

REV: 20150126

Application: For 98-05MERCEDES BENZ ML

Item	Part Name	QTY	Item	Part Name	QTY
1	Driver/Left Sidebar	1	10	M14x45mm Hex Bolt	10
2	Passenger/Right Sidebar	1	11	M14x30mm Hex Bolt (Front Brackets Only)	2
3	Drive Front Mounting Bracket (LF)	1	12	M14 Large Flat Washer	24
4	Passenger Front Mounting Bracket (RF)	1	13	M14 Lock Washer	12
5	Driver Rear Mounting Bracket (LR)	1	14	M14 Hex Nut	12
6	Passenger Rear Mounting Bracket (RR)	1	15	M8 Lock Washer	24
7	M12x45mm Hex Bolt	4	16	M8 Large Flat Washer	24
8	M12 Hex Nut	4	17	M8x30mm Hex Bolt	24
9	M12 Large Flat Washer	8	18	Driver Front Bracket & Passenger Rear Bracket (LB)	2
10	M12 Lock Washer	4	19	Driver Rear Bracket & Passenger Front Bracket (RB)	2

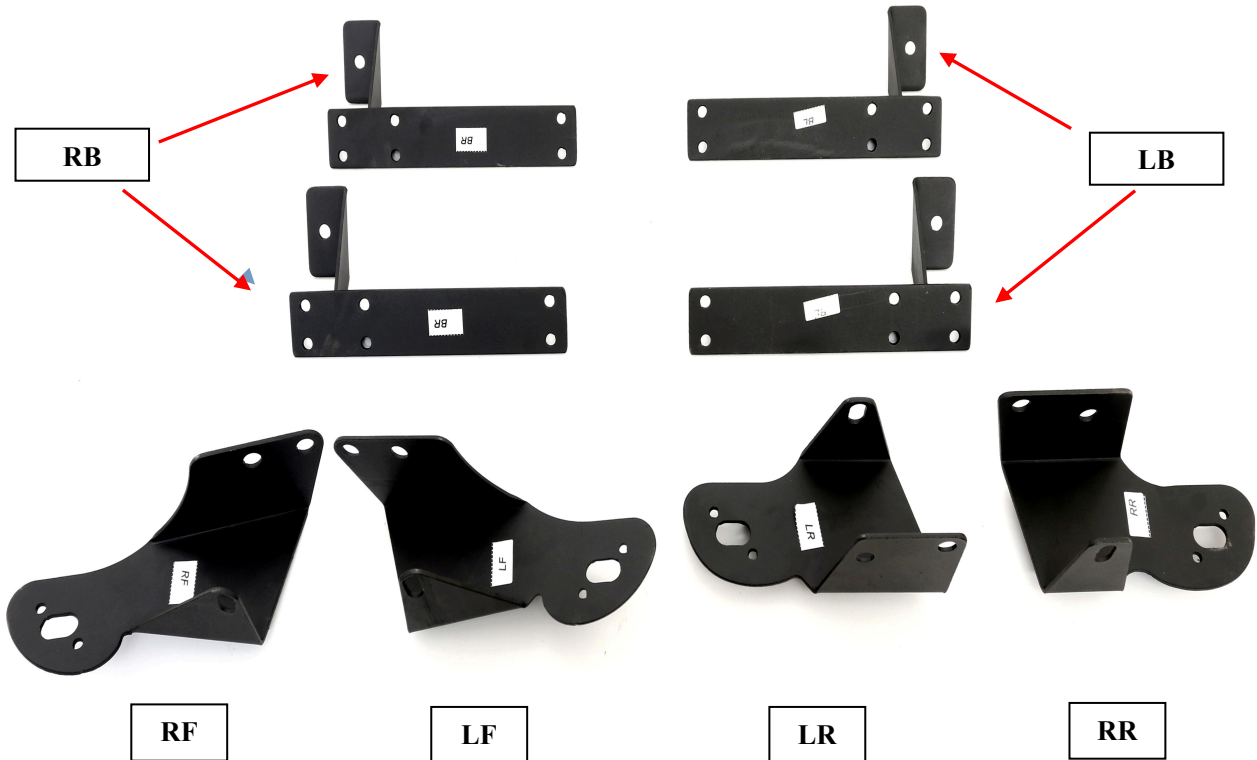

The instruction here is for your reference only. We strongly recommend the professional installer for best result. We are not responsible for any damage caused by the installation. Thank you for choosing our product!

Installation Instruction

Part#: IB26DJF3A

REV: 20150126

Application: For 98-05MERCEDES BENZ ML

Step	Installation Instruction
1	<u>CHECK PART LIST AND MAKE SURE ALL COMPONENTS ARE PRESENT. READ FOLLOWING INSTRUCTIONS CAREFULLY BEFORE STARTING INSTALLATION. DRILLING REQUIRED.</u>
2	Install the Bar Brackets on the Drive sidebar & Passenger sidebar, as shown Figure 1A & 1B .
3	Remove the factory hex bolts securing the plastic rocker panel cover on the driver side to the vehicle, (Fig 10). Place the cover on a clean surface.
4	Position the driver side front bracket up to the underside of the body mount-frame channel, (Fig 2). Bolt the Bracket to the back of the frame channel with (2) M14 x 45mm Hex Bolts, (4) M14 Flat Washers, (2) M14 Lock Washers and (2) M14 Hex Nuts, (Fig 3). Insert (1) M14 x 30mm Shorter Hex Bolt with (2) M14 Flat Washers , (1) M14 Lock Washer and (1) M14 Hex Nut into the front tab on the Mounting Bracket and into the frame channel. Do not tighten hardware at this time. IMPORTANT: Only use the (2) shorter M14 x 30mm Hex Bolts in the forward mounting location for the driver side and passenger side Front Mounting Brackets.
5	Next, install the driver side Rear Mounting Bracket, (Fig 4), as per the directions in Step 3 with the included (3) M14 x 45mm Hex Bolts, (6) M14 Flat Washers, (3) M14 Lock Washers and (3) M14 Hex Nuts, (Fig 5). Do not tighten hardware at this time.
6	.Select the driver Sidebar and carefully place it in position on top of the Brackets. Bolt the Sidebar to the Brackets with the included (2) M12 Hex Bolts, (2) M12 Lock Washers and (4) M12 Flat Washers, (Fig 10).
7	Level and align the Sidebar with the vehicle and tighten all hardware.
8	Repeat Steps 3-7 for the Passenger Sidebar installation.
9	Do periodic inspections to the installation to make sure all hardware is secure and tight.
<p>To protect your investment, wax this product after installing. Regular waxing is recommended to add a protective layer over the finish. Do not use any type of polish or wax that may contain abrasives that could damage the finish.</p> <p>For stainless steel: Aluminum polish may be used to polish small scratches and scuffs on the finish. Mild soap may be used also to clean the Sidebar.</p> <p>For gloss black finishes: Mild soap may be used to clean the Sidebar.</p>	

The instruction here is for your reference only. We strongly recommend the professional installer for best result. We are not responsible for any damage caused by the installation. Thank you for choosing our product!

Installation Instruction

Part#: IB26DJF3A

REV: 20150126

Application: For 98-05MERCEDES BENZ ML

Sidebar & Bar Bracket Assembly Shown:

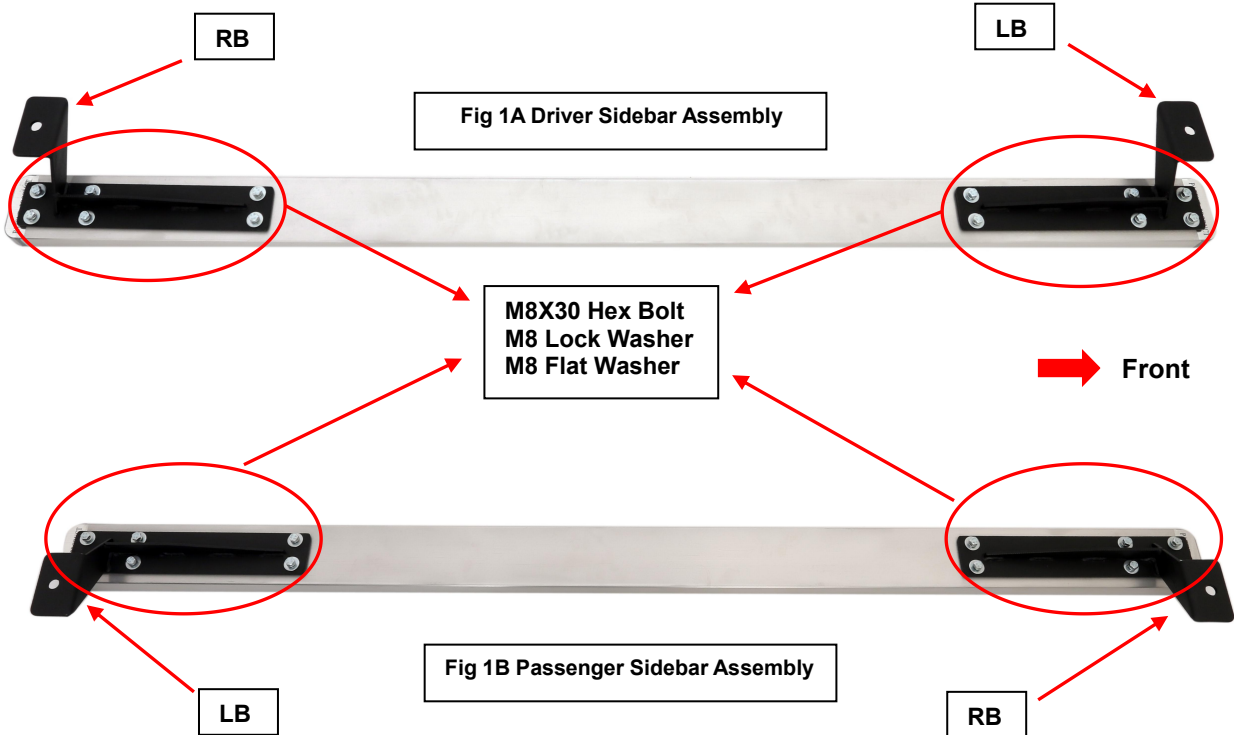

Driver Side Mounting Brackets Shows

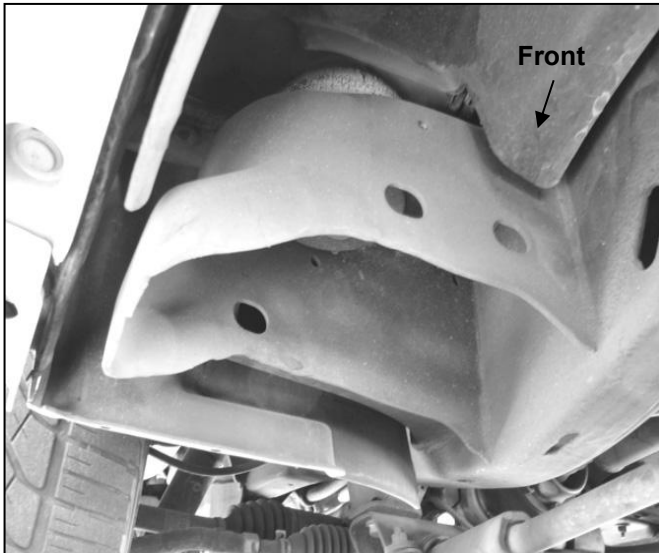

(Fig 2) Driver side front body mount pictured after plastic cover removed

- (2) M14 x 45mm Hex Bolts
- (4) M14 Flat Washers
- (2) M14 Lock Washers
- (2) M14 Hex Nuts

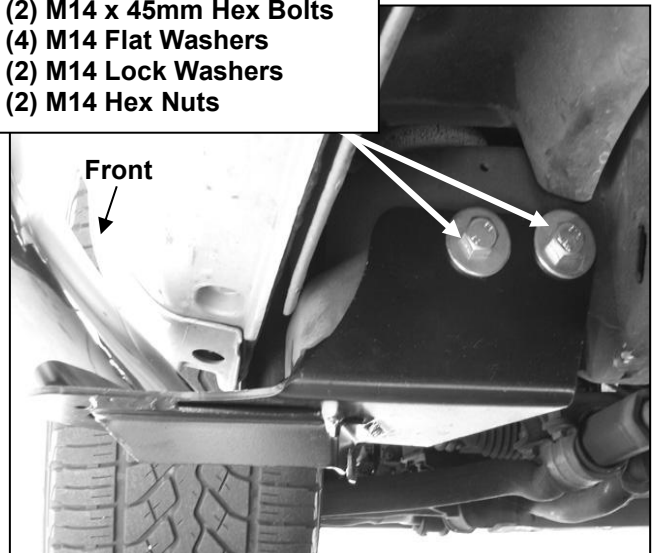

(Fig 3) Driver side front Mounting Bracket pictured after plastic cover removed

The instruction here is for your reference only. We strongly recommend the professional installer for best result. We are not responsible for any damage caused by the installation. Thank you for choosing our product!

Installation Instruction

Part#: IB26DJF3A

REV: 20150126

Application: For 98-05MERCEDES BENZ ML

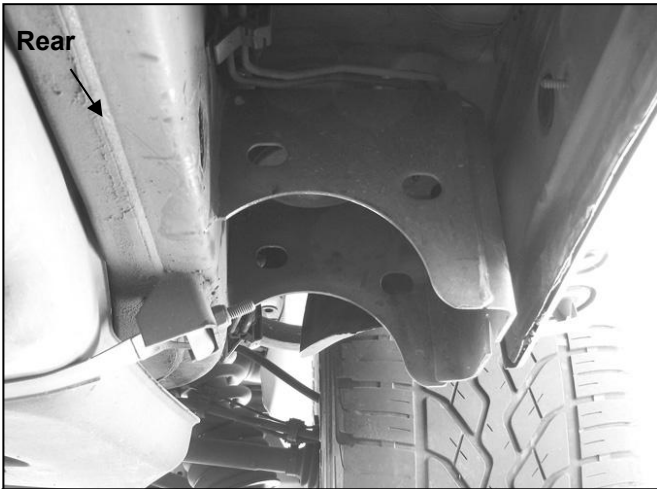

(Fig 4) Driver side rear body mount pictured after plastic cover removed

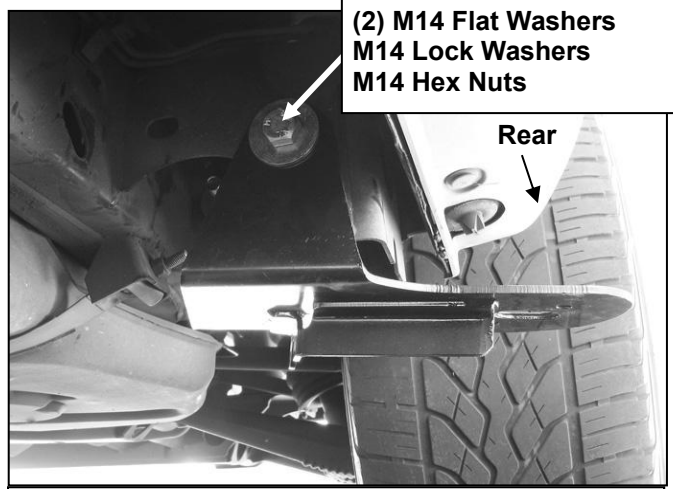

(Fig 5) Driver side rear Mounting Bracket pictured after plastic cover removed

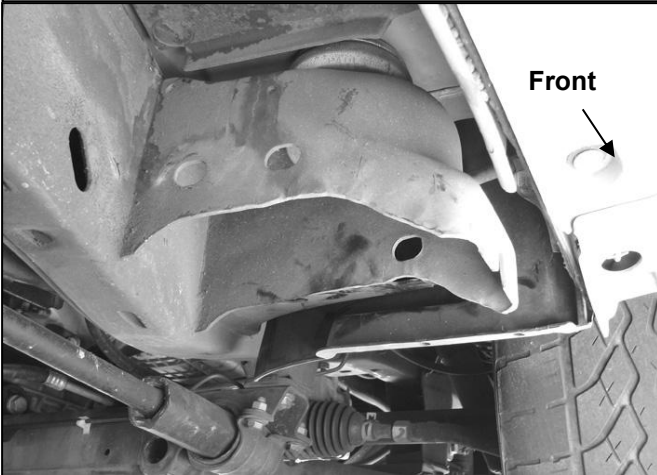

(Fig 6) Passenger side front body mount pictured after plastic cover removed

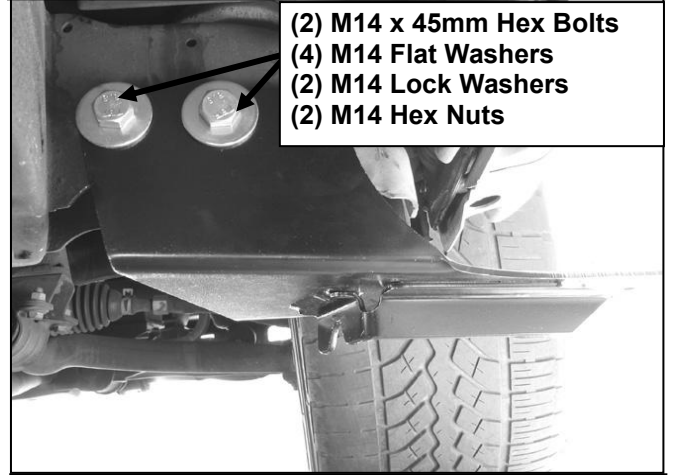

(Fig 7) Passenger side front Mounting Bracket pictured after plastic cover removed

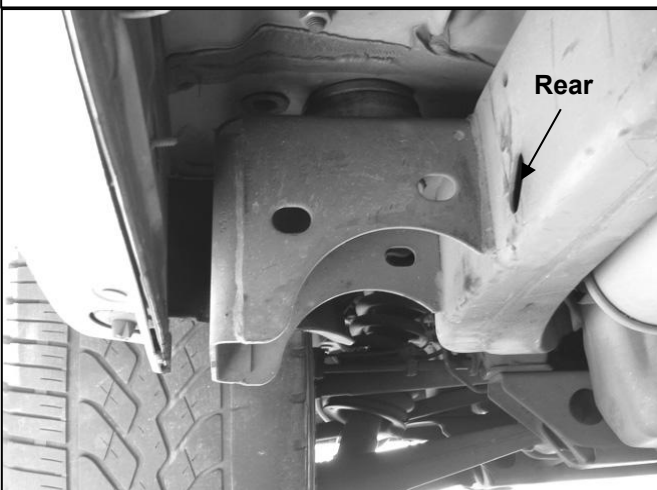

(Fig 8) Passenger side rear body mount pictured after plastic cover removed

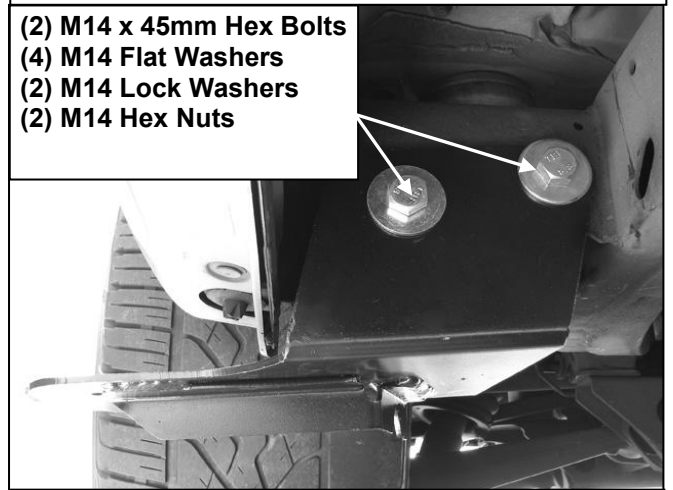

(Fig 9) Passenger side rear Mounting Bracket pictured after plastic cover removed

The instruction here is for your reference only. We strongly recommend the professional installer for best result. We are not responsible for any damage caused by the installation. Thank you for choosing our product!

Installation Instruction

Part#: IB26DJF3A

REV: 20150126

Application: For 98-05MERCEDES BENZ ML

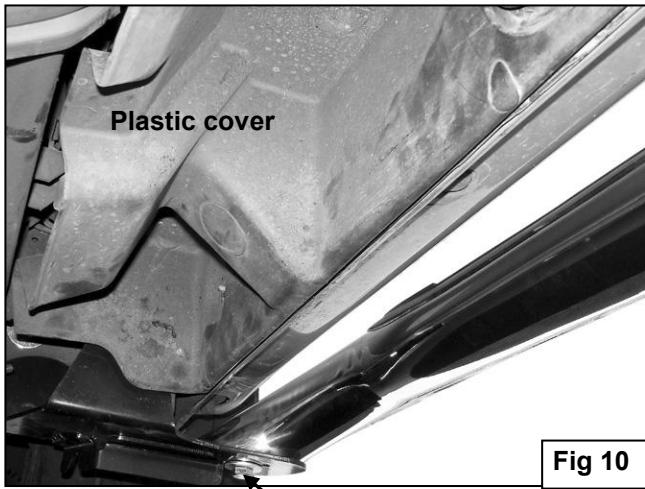

***Pictures are for reference only, actual brackets & bars may be a little different ***

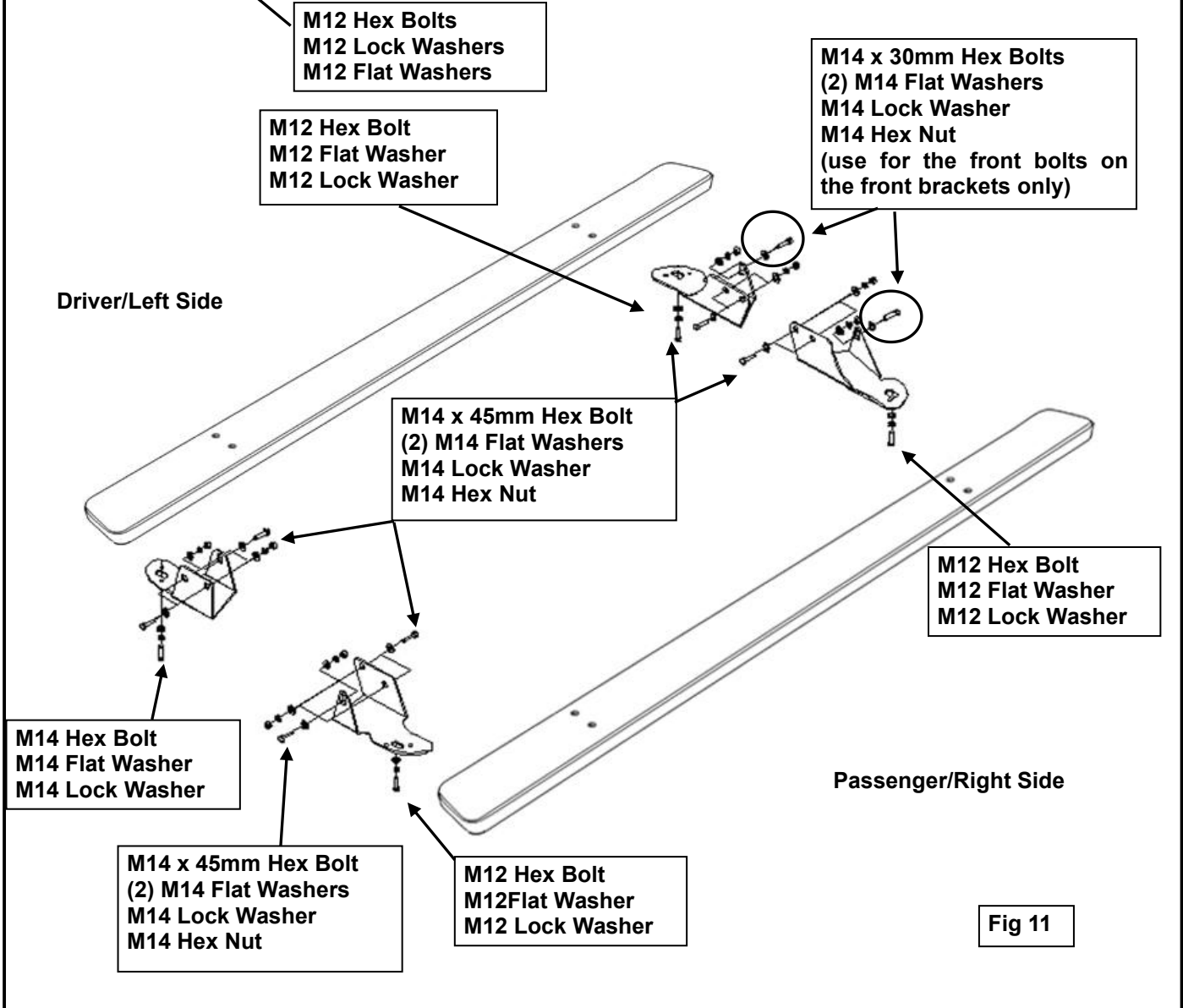

The instruction here is for your reference only. We strongly recommend the professional installer for best result. We are not responsible for any damage caused by the installation. Thank you for choosing our product!