

PARTS LIST:

Item	QTY	Description	Item	QTY	Description
#1	2	Running Board(use for left or right)	#14	4	12mm Lock Washer
#2	1	Driver/Left Front Mounting Bracket	#15	4	12mm x 24mm OD x 2.5mm Flat Washers
#3	1	Passenger/Right Front Mounting Bracket	#16	4	12-1.75mm Hex Nut
#4	1	Driver/Left Front Support Bracket	#17	2	8-1.25mm x 25mm Hex Bolt
#5	1	Passenger/Right Front Support Bracket	#18	4	8mm x 22mm OD x 2mm Flat Washers
#6	1	Driver/Left Center Mounting Bracket	#19	2	8-1.25mm Nylon Lock Nuts
#7	1	Passenger/Right Center Mounting Bracket	#20	12	6-1.0mm x 25mm Hex Bolts
#8	1	Driver/Left Rear Mounting Bracket	#21	10	6mm Lock Nuts
#9	1	Passenger/Right Rear Mounting Bracket	#22	2	6mm Lock Washers
#10	2	12mm x 40mm Short Button Head Bolt Plate	#23	22	6mm x 18mm OD x 1.6mm Small Flat Washers
#11	2	12mm x 35mm Long Bolt Plate	#24	12	6mm T-Bolts
#12	4	12mm Plastic Retainer	#25	12	6mm Lock Nuts
#13	2	14mm x 50mm x 4mm Spacer Washer	#26	12	6mm x 22mm OD x 2mm STD Flat Washers

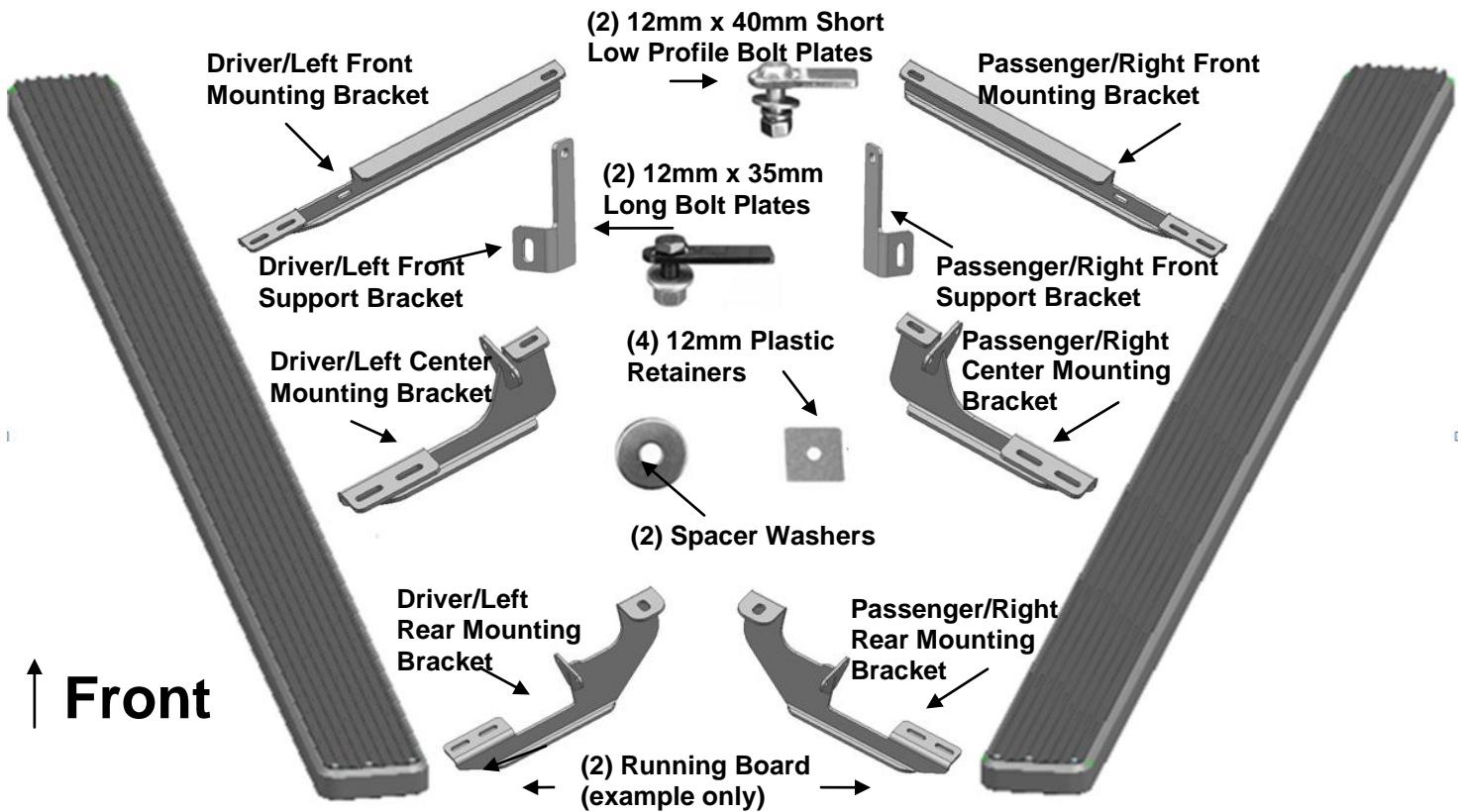

PROCEDURE:

REMOVE CONTENTS FROM BOX. VERIFY ALL PARTS ARE PRESENT. READ INSTRUCTIONS CAREFULLY BEFORE STARTING INSTALLATION. CUTTING AND DRILLING IS REQUIRED.

1. Starting at the front, passenger side of the vehicle, locate and remove the plastic cover attached to the bottom of the floor panel, **(Figure 1)**. Next, locate and remove the rubber plug in the bottom of the inner frame channel, **(Figure 2)**. Partially thread (1) 12mm Plastic Retainer onto (1) 12mm x 35mm Long Bolt Plate. Insert the Bolt Plate into the hole and thread the Retainer down tight to help hold the Bolt Plate in position, **(Figures 3A & 3B)**.
2. Select (1) Passenger Front Bracket and (1) Passenger Front Support Bracket, **(Figure 4)**. Bolt the bent end of the Support Bracket to the front facing side of the front Bracket with (1) 8mm x 25mm Hex Bolt, (2) 8mm Flat Washers, (1) 8mm Lock Washer and (1) 8mm Hex Nut. Snug but do not tighten hardware at this time.
3. Next, attach the inner end of the front Bracket assembly to the Bolt Plate with (1) 12mm Flat Washer (1) 12mm Lock Washer and (1) 12mm Hex Nut, **(Figure 5)**. Leave hardware loose at this time.
4. Line up the mounting tab on the front Support Bracket with the back of the pinch weld. Use a clamp to temporarily attach the Support Bracket to the pinch weld, **(Figure 6)**.
5. Move toward the center of the vehicle. Locate the last/rear threaded hole in the outer frame channel for the plastic cover removed in **Step 1, (Figure 1)**. Select the passenger Center Bracket. Bolt the Bracket to the threaded hole with (1) 6mm x 25mm Hex Bolt, (1) 6mm Lock Washer and (1) 6mm x 22mm STD Flat Washer, **(Figure 7)**. Do not tighten the hardware at this time.
6. Continue along the side of the vehicle and locate the rubber plug in the bottom of the floor panel directly in front of the rear suspension mount, **(Figure 8)**. Remove the plug. Partially thread (1) 12mm Plastic Retainer onto (1) 12mm x 40mm Short Low Profile Bolt Plate. Repeat **Step 1** to insert the Bolt Plate with Retainer into the hole, **(Figures 9A & 9B)**. Select the passenger rear Bracket. Slide (1) Large Spacer Washer over the Bolt Plate and Retainer, **(Figure 10A & 10B)**, then attach the passenger Rear Bracket to the Bolt Plate with (1) 12mm Flat Washer, (1) 12mm Lock Washer and (1) 12mm Hex Nut, **(Figure 11)**.
7. Push the mounting tab on the rear Bracket up tight against the back of the pinch weld. Use a clamp to help hold the Bracket in place if necessary. Snug but do not tighten the hardware at this time.
8. Select the Running Board. Slip (6)6mm T-Bolts into each bottom channel **(Figure 12)** Carefully position the Running Board onto the (3)Mounting Brackets. **IMPORTANT:** Do not slide the Running Board on the Brackets or damage to the finish may result. Attach the Running Board to the Mounting Brackets with (2) 6mm T-bolts,(2)6mm flat washers and (2)6mm lock nuts **(Figure 13&14)**. Do not tighten hardware.
9. Level and adjust the Running Board properly and tighten all Bracket to vehicle hardware. Make sure that the Running Board is level and that the mounting holes in the Brackets are not too close to the bottom edge of the pinch weld before marking any of the holes for the Brackets, **(Figure 15)**.
10. Mark the front, center and rear Support Bracket slot locations onto the back of the pinch weld, **(Figure 16)**. Temporarily remove the Running Board and Brackets. Remove the screws attaching the plastic rocker cover to the bottom of the body, **(Figure 11)**.
11. Drill 1/4" holes, (5 total), through the pinch weld at the previously marked front, center and rear Bracket locations. **IMPORTANT:** Be careful to avoid damaging the outer plastic rocker cover.
12. Remove the front Support Bracket from the front Bracket. Bolt the Support Bracket to the back of the pinch weld with (1) 6mm x 25mm Hex Bolt, (2) 6mm x 18mm Small Flat Washers and (1) 6mm Nylon Lock Nut, **(Figure 17)**. Leave hardware loose at this time.
13. Move to the center location and reinstall the Center Bracket. Bolt the mounting tab on the Bracket to the pinch weld with (2) 6mm x 25mm Hex Bolts, (4) 6mm x 18mm Small Flat Washers and (2) 6mm Nylon Lock Nuts, **(Figure 17)**. Leave hardware loose at this time.
14. Move to the rear Bracket location. Reinstall the Bracket and repeat **Step 15** to attach the rear support tab on the Bracket, **(Figure 17)**.
15. Reattach the lower rocker cover with the factory screws, **(see Step 12)**. **NOTE:** Trim the edge of the rocker cover around the 6mm Hex Bolts in pinch weld as required for proper fit and wrench access.
16. Temporarily attach the front Bracket to the front Support Bracket and Bolt Plate. Hold the large plastic cover removed in **Step 1** up against the bottom of the front Bracket. Mark the location of the Bracket

onto the inside of the cover, (**Figure 18A**). Remove the front Bracket. Cut a slot in the cover with a sharp knife or hacksaw blade, (**Figure 18B**). **IMPORTANT:** Only remove material necessary to clear the front Bracket. Do not cut through the inner or outer edge of the cover.

17. Next, locate the hole in the cover for the center Bracket mounting location. Trace the Bracket outline onto the cover. Cut a section out of the cover to clear the mounting tab on the Bracket, (**Figure 18B**).

IMPORTANT: Be very careful and do not cut complete through the outer edge. Remove the center Bracket and reinstall the plastic cover with the factory hardware.

18. Reinstall the front and center Brackets.

19. Reinstall the Running Board. Align, adjust and fully tighten all hardware at this time.

20. Repeat **Steps 1 - 21** for the driver side Running Board installation.

21. Do periodic inspections of the installation to make sure that all hardware is secure and tight.

To protect your investment, wax this product after installing. Regular waxing is recommended to add a protective layer over the finish. Do not use any type of polish or wax that may contain abrasives that could damage the finish.

Aluminum polish may be used to polish small scratches and scuffs on the finish. Mild soap may be used also to clean the Running Board.

Passenger Side Installation Pictured

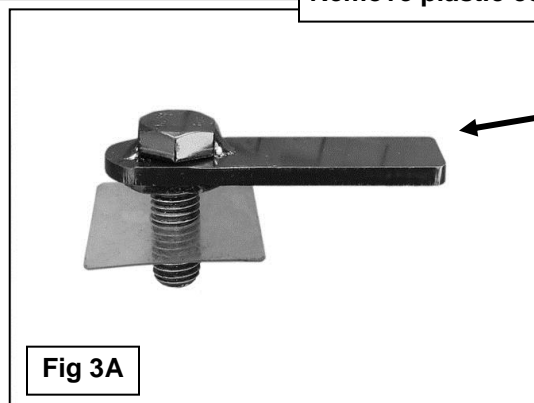
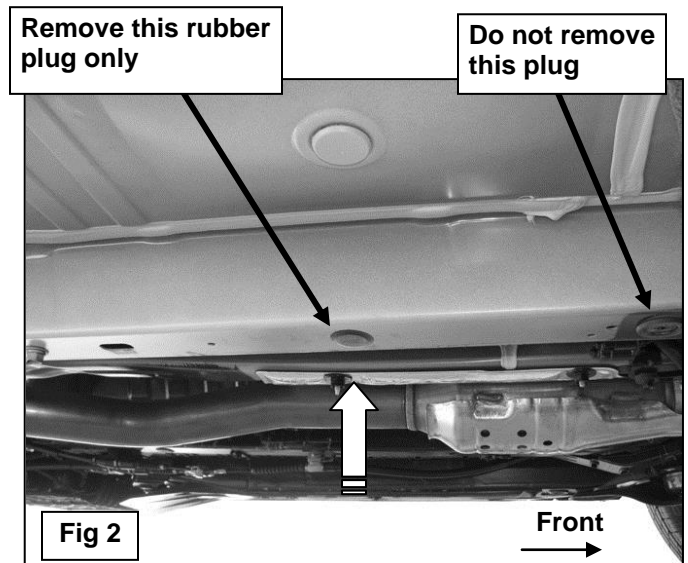
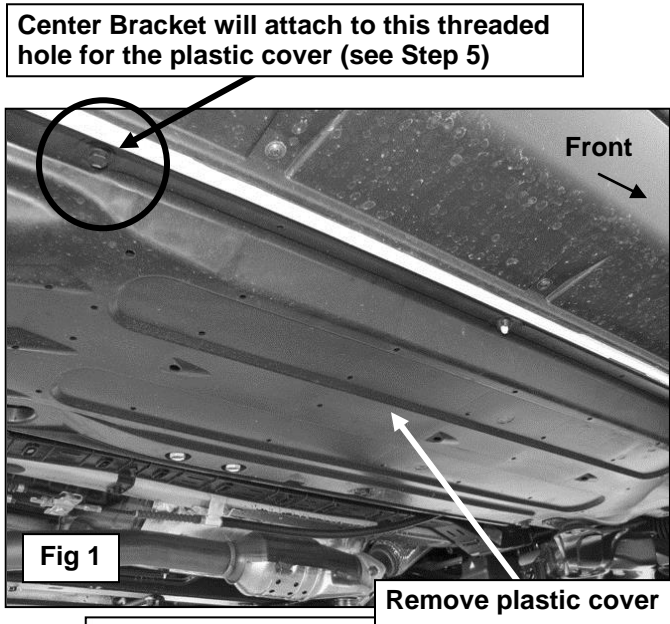

12mm x 35mm Long Bolt Plate with 12mm Plastic Retainer

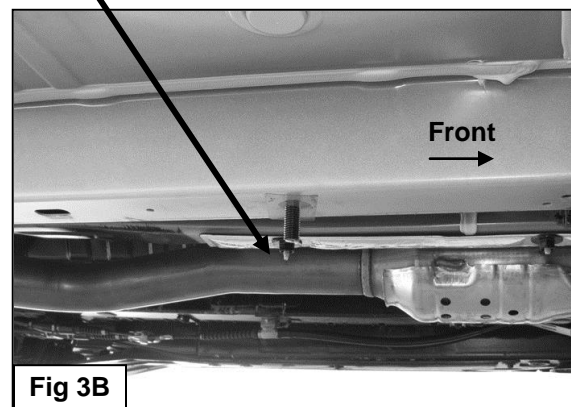

Passenger Side Installation Pictured

8mm x 25mm Hex Bolt
(2) 8mm Flat Washers
8mm Lock Washer
8mm Hex Nut

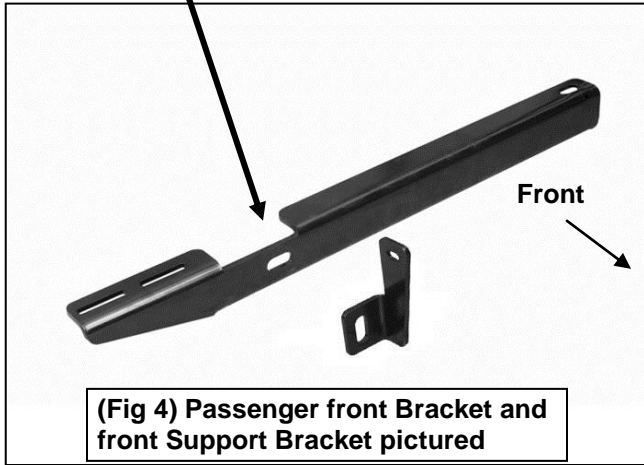

12mm Flat Washer
12mm Lock Washer
12mm Hex Nut

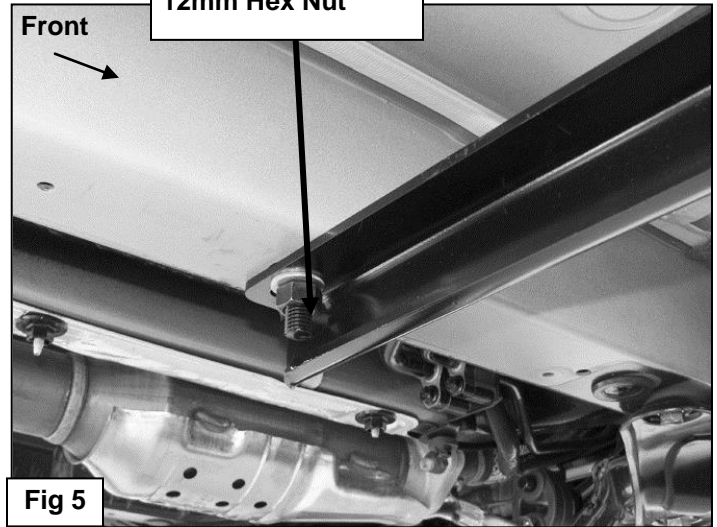

Use clamp to temporarily hold front Bracket up to pinch weld until final installation

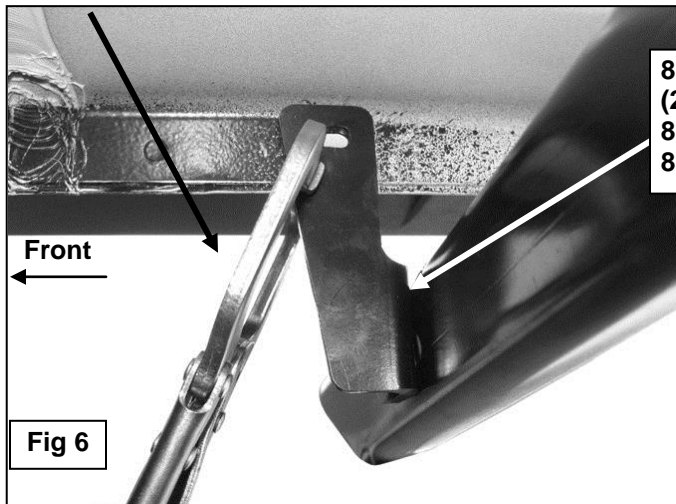

8mm x 25mm Hex Bolt
(2) 8mm Flat Washers
8mm Lock Washer
8mm Hex Nut

6mm x 25mm Hex Bolt
6mm Lock Washer
6mm Flat Washer

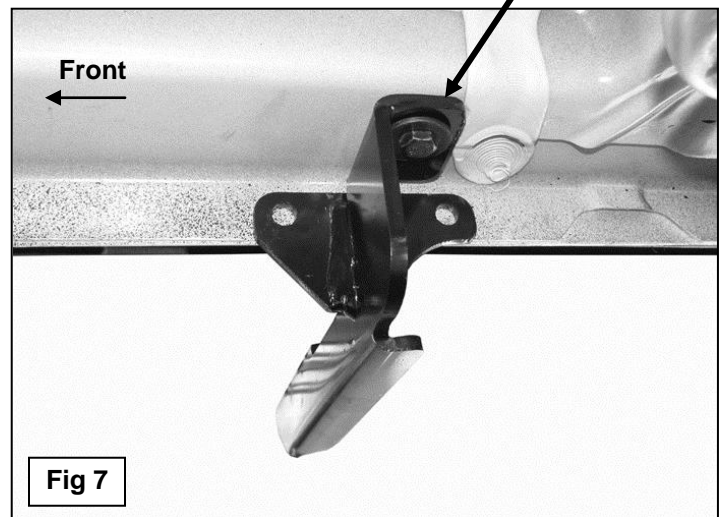

Rear trailing arm mount

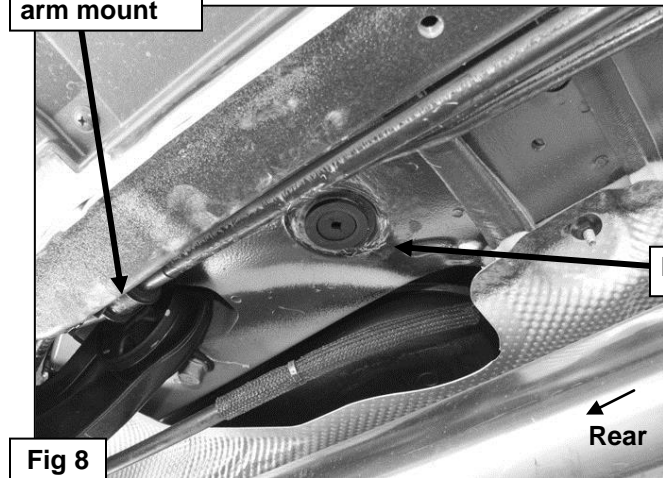

Passenger Side Installation Pictured

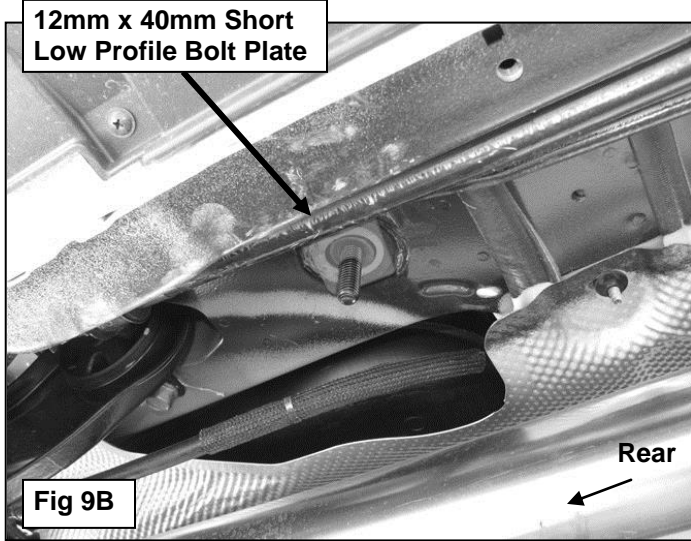

(Fig 10A) Insert Spacer between the Bracket and the body panel

12mm x 40mm Short Low Profile Bolt Plate

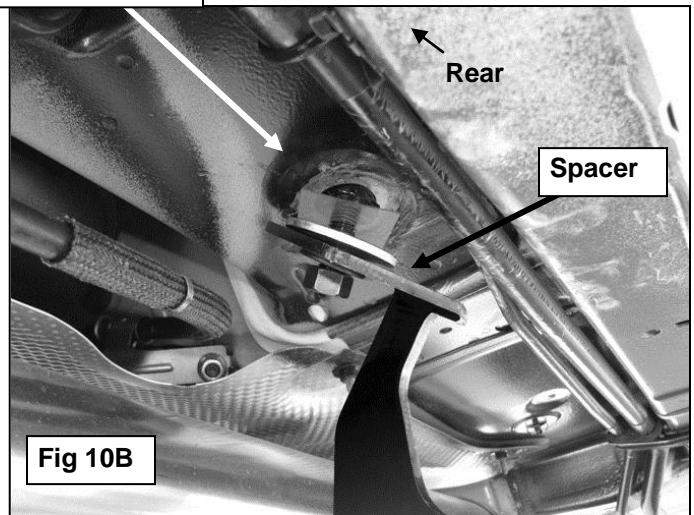

Insert Spacer between the Bracket and the body panel

12mm Lock Washer
12mm Flat Washer
12mm Hex Nut

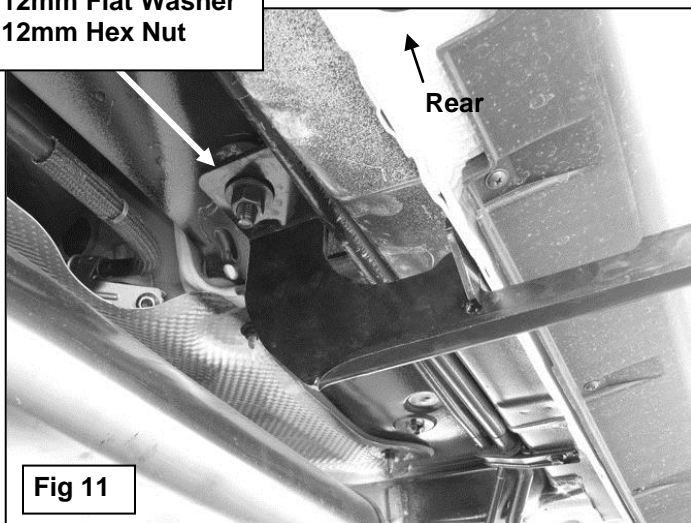

(Fig 12) Slip 6mm T-bolts into the bottom channel

Passenger Side Installation Pictured

- (2)6mmT-bolts
- (2)6mm Flat Washers
- (2)6mmLock nuts

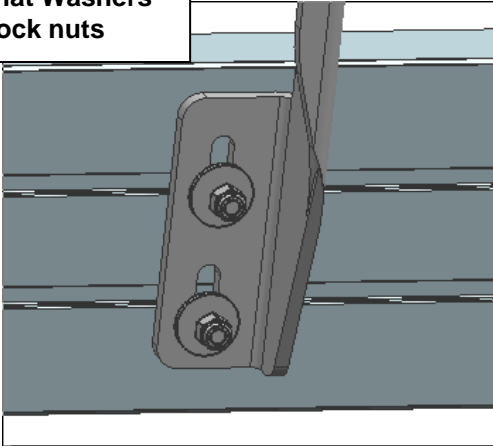

(Fig 13) Bracket installation

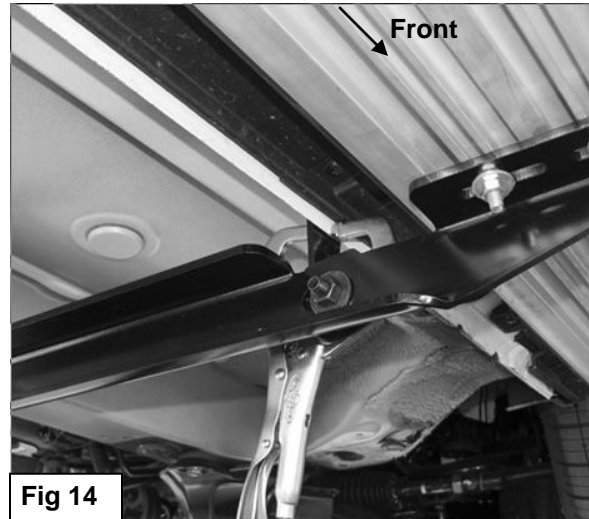

Fig 14

Use clamp to temporarily hold front Bracket up to pinch weld until final installation

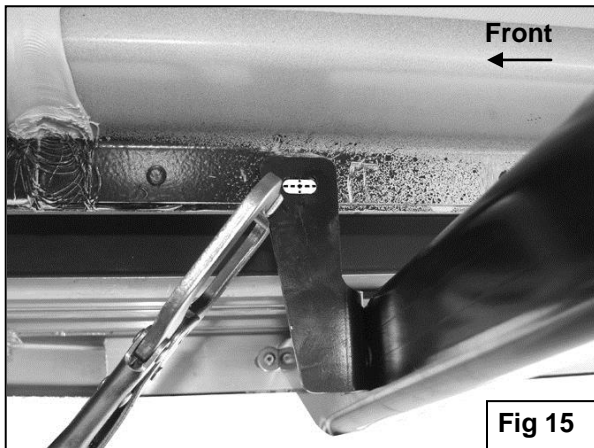

Fig 15

Mark the Bracket location onto back of pinch weld. Do not drill until after Running Board is properly aligned and adjusted. Use clamp to temporarily hold Support Bracket in place. Do not drill too close to bottom edge of pinch weld

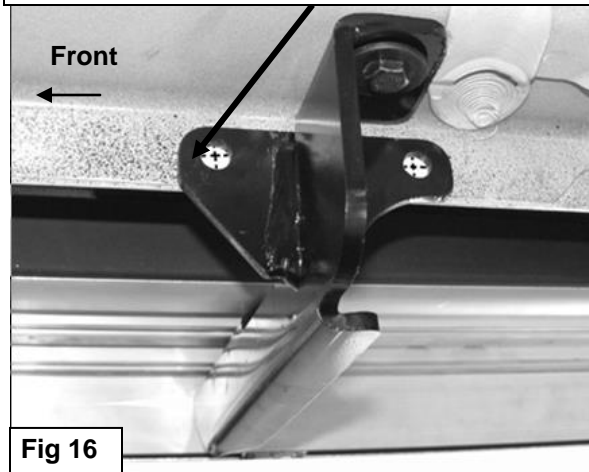

Fig 16

- (2) 6mm x 25mm Hex Bolts
- (4) 6mm x 18mm Small Flat Washers
- (2) 6mm Lock Washers
- (2) 6mm Hex Nuts

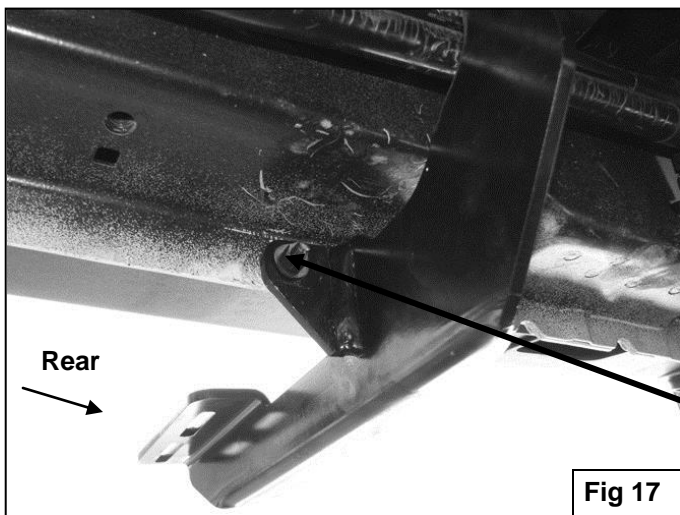
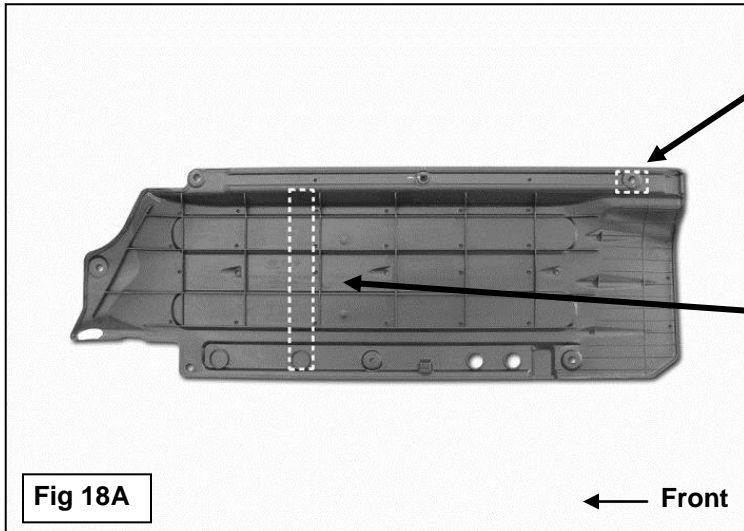

Fig 17

Passenger Side Installation Pictured



Outline of Center Bracket

After Running Board has been properly aligned and adjusted, hold the plastic cover up in place against the front Bracket. Trace the Bracket location onto the cover. Cut slot out of cover to clear front Bracket.

IMPORTANT: Do not cut through outer edge of the cover. Only remove material required for Bracket clearance

IMPORTANT: Do not cut through the inner or outer edge of the cover. Only remove material required for Bracket clearance

