

Parts List

Item	QTY	Description	Item	QTY	Description
#01	2	Running Board(use for left or right)	#11	6	10mm Lock Washers
#02	1	Driver Front Mounting Bracket (medium length)	#12	6	10mm x 30mm OD x 2.5mm Flat Washers
#03	1	Passenger Front Mounting Bracket (medium length)	#13	6	8-1.25mm x 35mm Hex Bolts
#04	1	Driver/Left Center Mounting Bracket (long)	#14	6	8mm Lock Washers
#05	1	Passenger/Right Center Mounting Bracket (long)	#15	6	8mm x 28mm OD x 3mm Large Flat Washers
#06	1	Driver/Left Rear Mounting Bracket (short)	#16	12	6-1.0mm x 25mm Button Head Bolts
#07	1	Passenger/Right Rear Mounting Bracket (short)	#17	24	6-1.0mm x 20mm T-Bolts
#08	1	4mm Allen Wrench	#18	48	6mm ID x 22mm OD x 2mm Flat Washers
#09	6	10mm Nut Plates	#19	36	6mm Nylon Lock Nuts
#10	6	10-1.5mm x 35mm Hex Bolts			

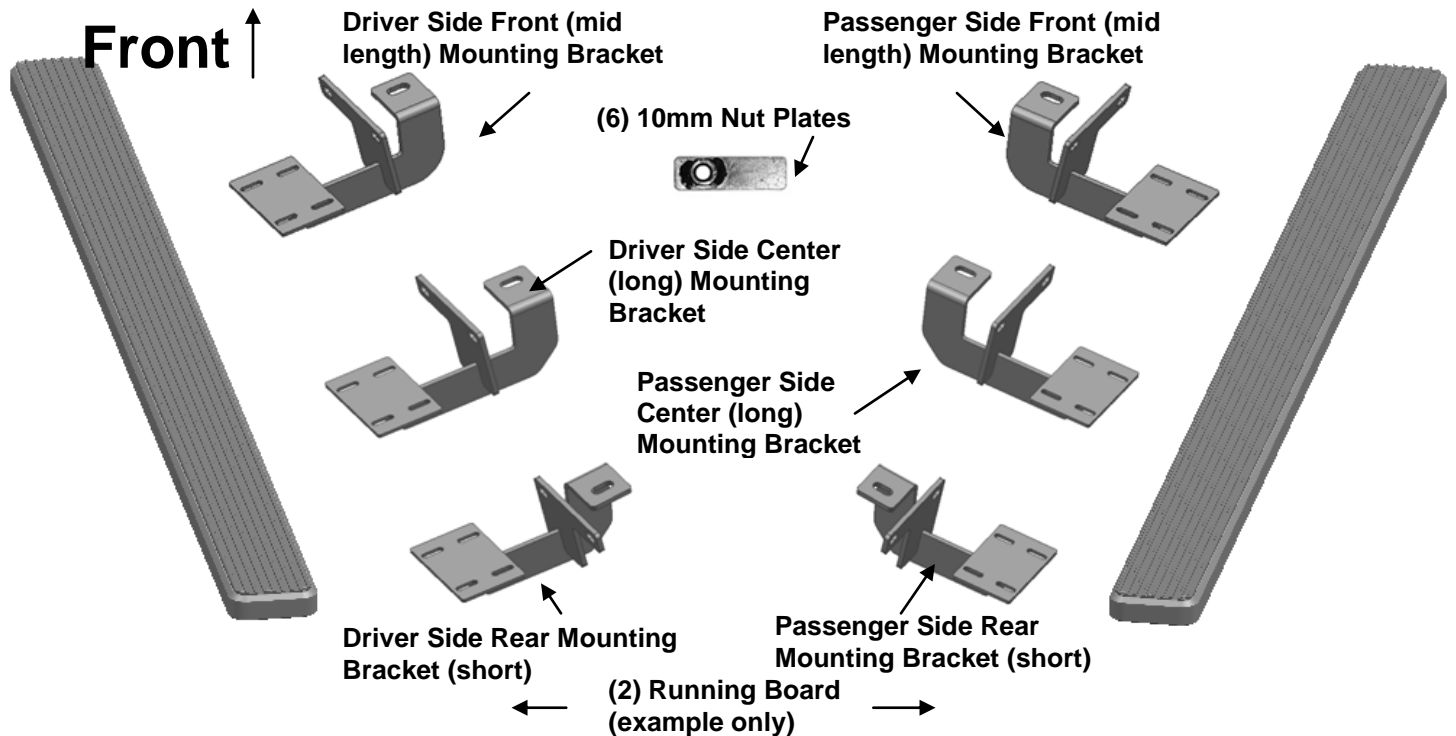

PROCEDURE:

1. REMOVE CONTENTS FROM BOX. VERIFY ALL PARTS ARE PRESENT. READ INSTRUCTIONS CAREFULLY BEFORE STARTING INSTALLATION. FACTORY INSTALLED OR AFTERMARKET "ROCK RAILS," SIDE STEPS OR RUNNING BOARDS MUST BE REMOVED.
2. Start installation toward the front of the passenger side of the vehicle. Determine if the vehicle has an open floor panel or a threaded hole in the floor panel for the top tab on the Bracket, (Figures 1 - 2). Remove any insulation that may be covering the mounting locations.
3. Select the passenger side front Bracket. **VERY IMPORTANT:** The 6 Mounting Brackets look very similar. Use the instructions to properly identify the front, center and rear Brackets for either side of the vehicle. Each bracket has been designed for a specific location for proper installation.
 - a. **Vehicles with open mounting location:** Insert (1) 10mm Nut Plate into the large square opening in the floor panel. Line up the threaded nut with the small hole in line with the tab on the Bracket, (Figure 1). Bolt the Bracket to the Nut Plate with (1) 10mm x 35mm Hex Bolt, (1) 10mm Lock Washer and (1) 10mm Flat Washer, (Figure 3A). Do not tighten hardware.
 - b. **Vehicles with factory threaded hole in floor panel:** Bolt the tab on the Bracket to the threaded hole in the floor panel with (1) 8mm x 35mm Hex Bolt, (1) 8mm Lock Washer and (1) 8mm x 28mm OD Large Flat Washer, (Figures 2 & 3A). Do not tighten hardware.

4. Line up the mounting plate on the Bracket with the (2) factory holes in the pinch weld. Bolt the Mounting Bracket to the **back** of the pinch weld using the included (4) 6mm x 25mm Button Head Allen Bolts, (against pinch weld), (2) 6mm x 22mm OD Large Flat Washers, (inside against the bracket), and (2) 6mm Nylon Lock Nuts, **(Figure 3A)**. Leave loose at this time.
5. Repeat **Steps 2 – 4** for Center and Rear Mounting Bracket installation. Use the instructions to correctly identify the Brackets, **(Figures 3B, 3C, 3D & 4)**.
1. Once all three Mounting Brackets are securely in position, Select the Running Board. Slip (12) 6mm T-Bolts into each bottom channel **(Figure 5)**. Carefully position the Running Board onto the Mounting Brackets. Attach the Running Board to the Mounting Brackets with (4) 6mm T-bolts, (4) 6mm flat washers and (4) 6mm lock nuts, **(Figure 6)**. Do not tighten hardware at this time.
6. Adjust and level the Running Board and tighten all hardware.
7. Repeat **Steps 2 - 7** for Running Board installation.
8. Do periodic inspections to the installation to make sure that all hardware is secure and tight.

To protect your investment, wax this product after installing. Regular waxing is recommended to add a protective layer over the finish. Do not use any type of polish or wax that may contain abrasives that could damage the finish.

For Polished Finishes: Aluminum polish may be used to polish small scratches and scuffs on the finish. Mild soap may be used also to clean the Running Board.

For Black Finishes: Mild soap may be used to clean the Running Board.

Passenger Side Installation Pictured

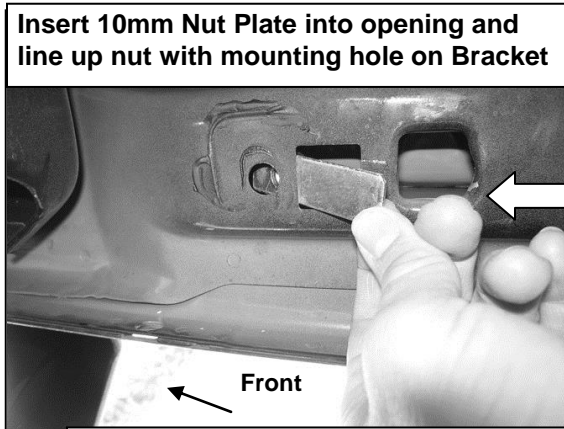

(Fig 1) Opening in floor frame channel (passenger side-front pictured)

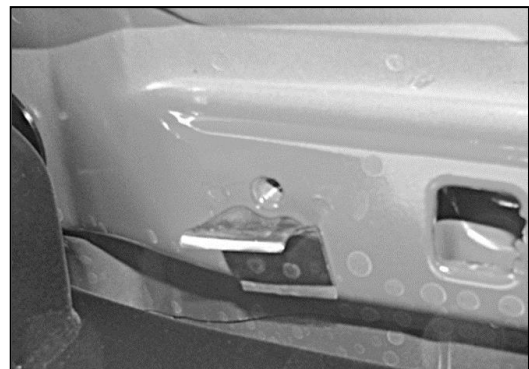

(Fig 2) 8mm threaded hole in floor frame channel (passenger side-front pictured for example)

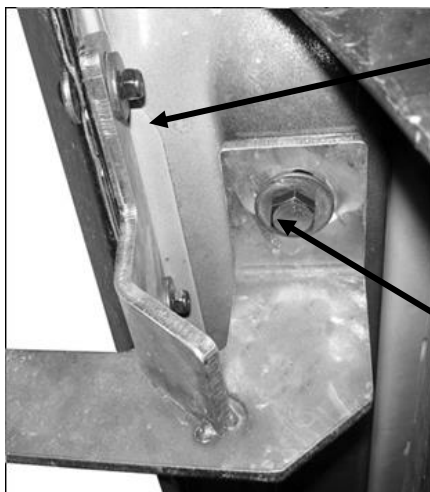

(Fig 3A) Passenger side Front Mounting Bracket installation pictured ("mid length" bracket)

- (2) 6mm x 25mm Button Head Bolts
- (4) 6mm Flat Washers
- (2) 6mm Nylon Lock Nuts

- 10mm Nut Plate
- 10mm x 35mm Hex Bolt
- 10mm Lock Washer
- 10mm Flat Washer
- OR
- 8mm x 35mm Hex Bolt
- 8mm Lock Washer
- 8mm x 28mm OD x 3mm Large Flat Washer

Passenger Side Installation Pictured

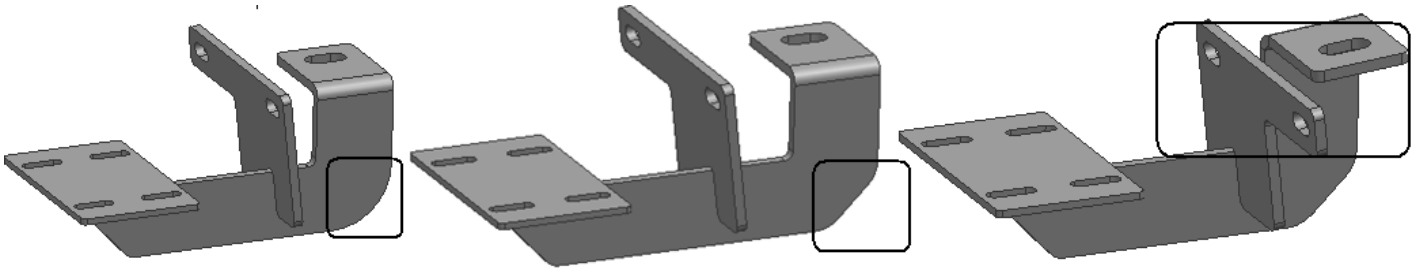

Passenger side "mid-length" front Bracket pictured

(Fig 3A) Passenger side "long" center Bracket pictured

Passenger side "short" rear Bracket pictured

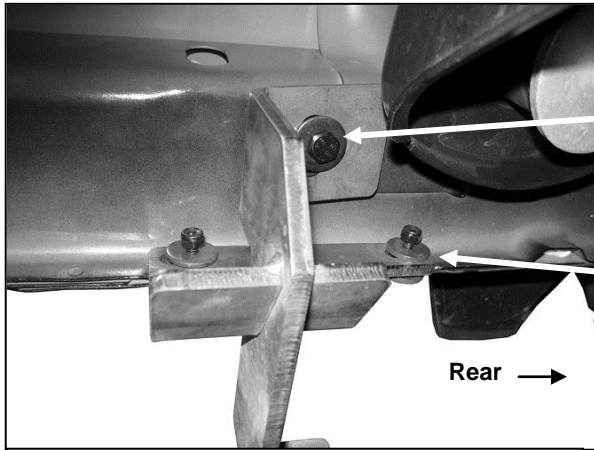

- 10mm Nut Plate
- 10mm x 35mm Hex Bolt
- 10mm Lock Washer
- 10mm Flat Washer
- OR
- 8mm x 35mm Hex Bolt
- 8mm Lock Washer
- 8mm x 28mm OD x 3mm Large Flat Washer

- (2) 6mm x 25mm Button Head Bolts
- (4) 6mm Flat Washers
- (2) 6mm Nylon Lock Nuts

(Fig 4) Passenger side Rear Mounting Bracket installation pictured (short bracket)



(Fig 5) Slip 6mm T-bolts into the bottom channel

- (4)6mmT-bolts
- (4)6mm Flat Washers
- (4)6mmLock nuts

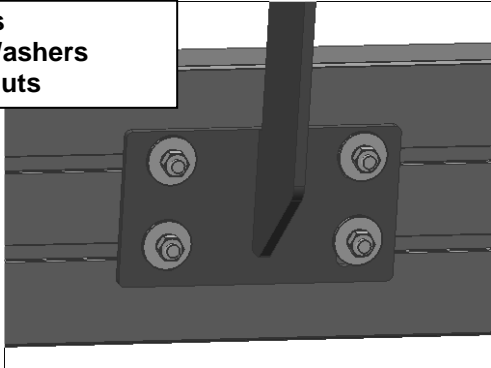

(Fig 6) Bracket Installation