

iRunning Board Installation Instruction

REV: 20170601

Application: FOR 2009-2017 Dodge Ram 1500 Quad Cab

Item	Part Name	QTY	Item	Part Name	QTY
1	Step Bar	2	13	M10 Revit Insert Nuts	5
2	Passenger/Right Mounting Bracket (RB)	3	14	M10-1.5mm x 30mm Hex Bolts	5
3	Driver/Left Front Mounting Bracket(LFB)	1	15	Plastic Retainers	6
4	Driver Mounting Bracket (LB)	2	16	M8 Nylon Lock Nuts	1
5	Driver/Left Front Support Bracket (LFS)	1	17	M8-1.25mm x 30mm Hex Bolts	12
6	M10 Nut / M12 Bolt Plate	6	18	8mm Flat Washers	13
7	M12 Hex Nut	5	19	M8 Lock Washers	11
8	M12 Lock Washer	5	20	M6-1.0mm x 25mm Hex Bolts	2
9	12mm Flat Washers	5	21	M6 Square head Bolt	12
10	M10-1.5mm x 40mm Hex Bolts	6	22	M6 Nylon Lock Nuts	14
11	10mm Flat Washers	11	23	6mm Flat Washers	16
12	M10 Lock Washers	11			



Step	Installation Instruction
1	REMOVE CONTENTS FROM BOX. VERIFY ALL PARTS ARE PRESENT. READ INSTRUCTIONS CAREFULLY BEFORE STARTING INSTALLATION. DRILLING MAY BE REQUIRED.
2	Starting at the driver side-front of the vehicle, remove the sealing tape covering the factory holes in the side of the inner panel, (Fig 1) .
3	<p><u>For Models without factory threaded inserts on the body panel:</u></p> <p>a. Insert the M12 Bolt W/ Nut Plate into the factory oval hole. And then Thread down the 12mm Plastic Retainer onto the M12 bolt until it is flush against the sheet metal to prevent the M12 Bolt W/ Nut Plate from falling down into the oval hole. As shown on Fig 2.</p> <p>b. Attach the driver side front Mounting Bracket (LFM) to the inner panel and rotate the M12 Bolt W/ Nut Plate until the welded nut end lines up with the hole on the Mounting Bracket. Secure with (1) M10x35mm Hex Bolt, (1) M10 Lock Washer and (1) M10 Flat Washer, (Fig 3 & 6). Keep them snug but do not tighten hardware at this time.</p>

The instruction here is for your reference only. We strongly recommend the professional installer for best result. We are not responsible for any damage caused by the installation. Thank you for choosing our product!

iRunning Board Installation Instruction

REV: 20170601

Application: FOR 2009-2017 Dodge Ram 1500 Quad Cab

4	<p>For Models with Factory threaded inserts on the body panel (Fig 4): Attach the Driver Front Mounting Bracket (LFM) onto the threaded insert with (1) M8X30mm Hex Bolt, (1) M8 Lock Washer & (1) M8 Flat Washer (Fig 4, 5). Leave the hardware loose.</p>
5	<p>Attach the Drive Front Support Bracket (LFS) to the back side of the Front Mounting Bracket (LFM) with (1) M8X30mm Hex Bolt, (2) M8 Flat Washers & (1) M8 Nylon Lock Nut. (Fig 4 & 6). Rotate the Support Bracket (LFS) to the back of the pinch weld. Line up the slot in the top of the Support Bracket with the factory holes on the pinch weld. Attach the Bracket to the pinch weld with (2) M6 Hex Bolts, (4) M6 Flat Washers & (2) M6 Nylon Lock Nuts. (Fig 5,6,7). Do not Fully tighten at this time. Important: 09-10 models are not equipped with factory holes and will require drilling through the pinch weld to attach the Support Bracket. Do not drill through pinch weld at this time.</p>
6	<p>Move to the Driver Center Bracket (LC). For Models without factory threaded inserts on the body panel: Select (1) M12 Bolt W/ Nut Plate, repeat Step 3 to install the Bolt W/ Nut Plate(Fig 8). Attach the driver Center Bracket (LC) to the Bolt W/ Nut Plate with (1) M12 Flat Washer, (1) M12 Lock Washer & (1) M12 Hex Nut. (Fig 10). Do not tighten hardware at this time. Option: Insert a M10 Rivet Insert Nut into the hole on rocker panel, and secure the Center Bracket with (1)M10X30mm Hex Bolt, (1) 10mm Flat Washer, (1) 10mm Lock Washer.(Fig 8 ,9&10)</p> <p>For Models with Factory threaded inserts on the body panel (Fig 4): Attach the Driver Centre Mounting Bracket (LC) onto the threaded insert with (2) M8X30mm Hex Bolt, (2) M8 Lock Washer & (2) M8 Flat Washer (Fig 10). Leave the hardware loose.</p>
7	<p>For rear mounting bracket installation of the driver side, use bracket (LR) and the same installation procedure as step 6</p>
8	<p>Once all (3) Brackets have been installed, Select a Running Board. Slide (3) 6mm T-Bolts into each bottom channel (Figure 11).Carefully position the Running Board onto the Mounting Brackets. Attach the Running Board to the Mounting Brackets with (6) 6mm T-bolts,(6)6mm flat washers and (6)6mm lock nuts, (Figure 12). Do not tighten hardware at this time.</p>
9	<p>Level and adjust the Side Bar and Brackets and tighten all hardware. 09-10 Models requiring drilling for Driver Front Support Bracket (LFS):</p> <ol style="list-style-type: none">Make sure the sidebar is level to the vehicle. Line up the slot on the Support Bracket with the back of the pinch weld. Mark the location of the slot onto the pinch weld.Drill (2) ¼" holes through the pinch weld. Important: Do not drill too close to the bottom edge of the pinch weld. Drill the holes toward the outside of the marked slot.Attach the Support Bracket to the pinch weld with (2) M6 X25 Hex Bolts, (4) M6 Flat Washers, (2) M6 nylon Lock Nuts. (Fig 13).Check for level then fully tighten all hardware.
10	<p>Repeat Steps 3-8 for installing passenger side brackets. Note: Installation procedure of passenger side front bracket is the same as Centre and rear.</p>
11	<p>Installation completed!!! (See Fig 14).</p>

To protect your investment, wax this product after installing. Regular waxing is recommended to add a protective layer over the finish. Do not use any type of polish or wax that may contain abrasives that could damage the finish.
For Polished Finishes: Aluminum polish may be used to polish small scratches and scuffs on the finish. Mild soap may also be used to clean the Sidebar.
For Black Finishes: Mild soap may be used to clean the Sidebar.

The instruction here is for your reference only. We strongly recommend the professional installer for best result. We are not responsible for any damage caused by the installation. Thank you for choosing our product!

iRunning Board Installation Instruction

REV: 20170601

Application: FOR 2009-2017 Dodge Ram 1500 Quad Cab

Driver/Left Side Installation Pictured



Fig 1A. Driver Front Location



Fig 1A. Driver Centre Location

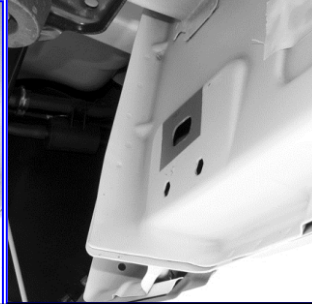
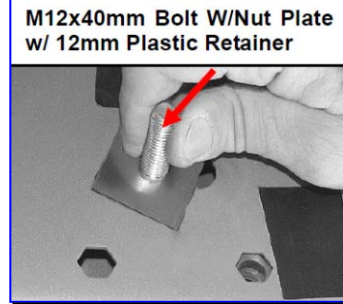

Fig 1A. Driver Rear Location



M12x40mm Bolt W/Nut Plate w/ 12mm Plastic Retainer

Fig 2

12mm x 35mm Bolt/10mm Nut Plate
12mm Plastic Retainer

Rotate Bolt/Nut Plate to line up correct threaded hole with body panel and hole in Mounting Bracket (see arrow)

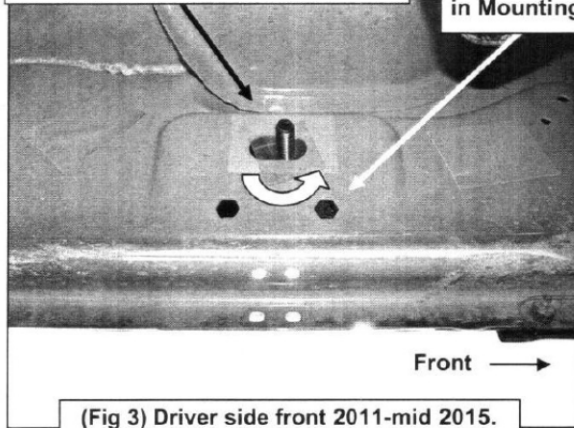

(Fig 3) Driver side front 2011-mid 2015. NOTE no threaded insert in body panel

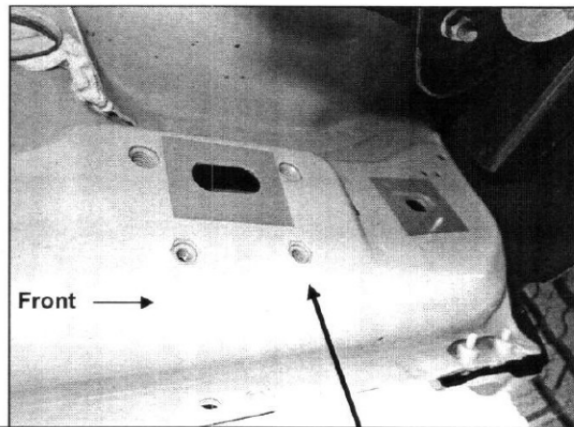

(Fig 4) Driver side front mid 2015-on and example of all models with factory installed threaded inserts

- (1) M8X30mm Hex Bolt
- (2) M8 Flat Washer
- (1) M8 Nylon Lock Nut

Models W/O factory threaded inserts:

- (1) M10X35mm Hex Bolt
- (1) M10 Flat Washer
- (1) M10 Lock Washer

Models W/ factory threaded inserts:

- (1) M8X30mm Hex Bolt
- (1) M8 Flat Washer
- (1) M8 Lock Washer

Driver Front Support Bracket

Driver Front Mounting Bracket

(Fig 5) Driver Front Mounting Bracket Assembly (For with factory installed threaded insert)

The instruction here is for your reference only. We strongly recommend the professional installer for best result. We are not responsible for any damage caused by the installation. Thank you for choosing our product!

iRunning Board Installation Instruction

REV: 20170601

Application: FOR 2009-2017 Dodge Ram 1500 Quad Cab

Driver Side Installation Pictured

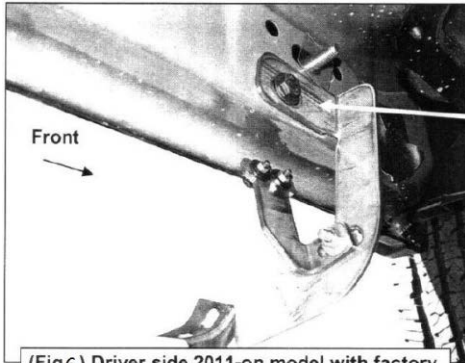

(Fig6) Driver side 2011-on model with factory holes in pinch weld pictured.

IMPORTANT: 2009-2010 models without holes in pinch weld will require drilling 1/4" holes through pinch weld to attach driver side front support bracket. Do complete installation of sidebars first, level sidebar before drilling holes for support bracket.

Models without threaded insert using Bolt/Nut Plate, use:
 10mm x 35mm Hex Bolt
 10mm Lock Washer
 10mm Flat Washer

Models with threaded insert use:
 8mm x 30mm Hex Bolt
 8mm Lock Washer
 8mm Flat Washer

(2) M6X25mm Hex Bolt
 (4) M6 Flat Washer
 (2) M6 Nylon Lock Nut

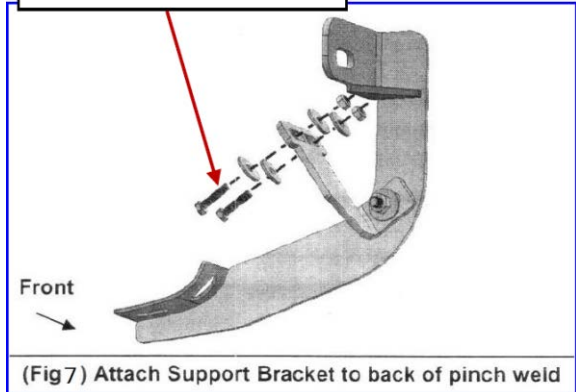

(Fig 7) Attach Support Bracket to back of pinch weld

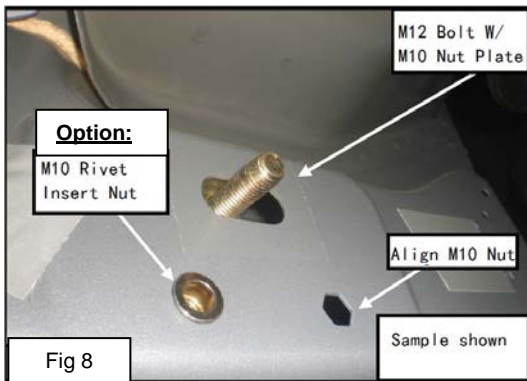

Fig 8



Fig 9. M10 Rivet Insert Nut installation

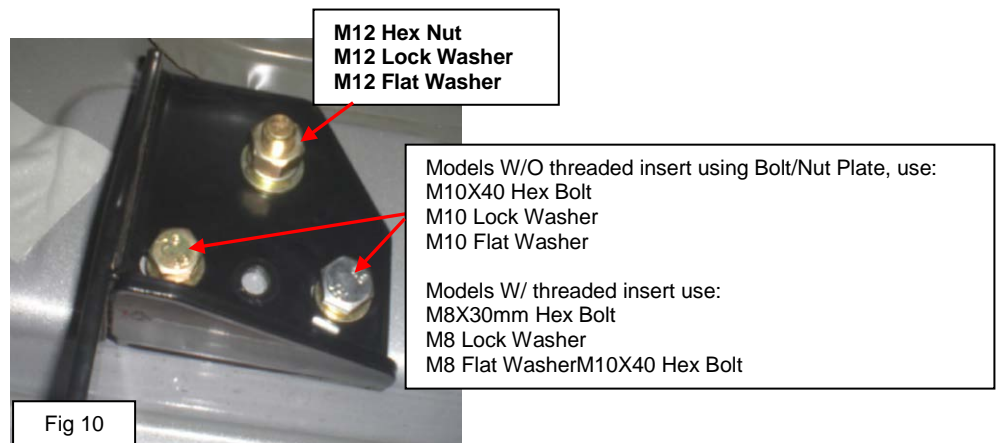

Fig 10

M12 Hex Nut
 M12 Lock Washer
 M12 Flat Washer

Models W/O threaded insert using Bolt/Nut Plate, use:
 M10X40 Hex Bolt
 M10 Lock Washer
 M10 Flat Washer

Models W/ threaded insert use:
 M8X30mm Hex Bolt
 M8 Lock Washer
 M8 Flat Washer M10X40 Hex Bolt

The instruction here is for your reference only. We strongly recommend the professional installer for best result. We are not responsible for any damage caused by the installation. Thank you for choosing our product!

iRunning Board Installation Instruction

REV: 20170601

Application: FOR 2009-2017 Dodge Ram 1500 Quad Cab

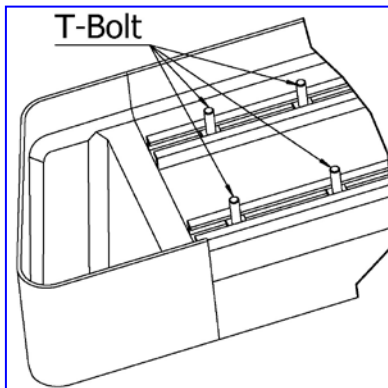

Fig 11. Slide 6mm T-Bolts into the bottom Channel

(2)6mm T-bolts
(2)6mm Flat Washers
(2)6mm Lock nuts

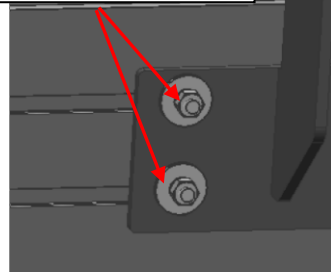
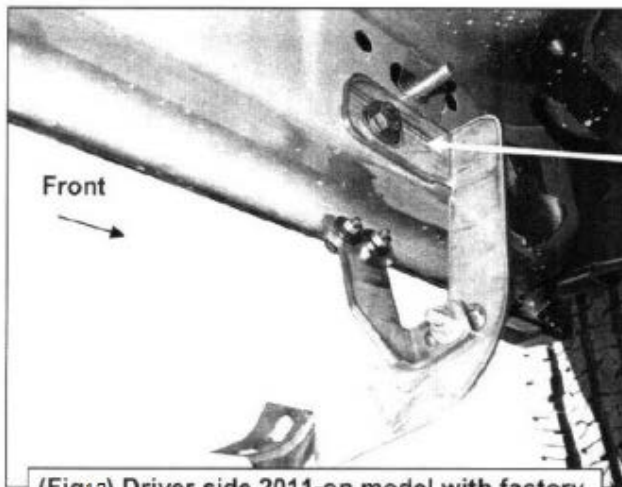

Fig 12 Bracket installed (For Reference Only)



(Fig13) Driver side 2011-on model with factory holes in pinch weld pictured.

IMPORTANT: 2009-2010 models without holes in pinch weld will require drilling 1/4" holes through pinch weld to attach driver side front support bracket. Do complete installation of sidebars first, level sidebar before drilling holes for support bracket.

Models without threaded insert using Bolt/Nut Plate, use:
10mm x 35mm Hex Bolt
10mm Lock Washer
10mm Flat Washer

Models with threaded insert use:
8mm x 30mm Hex Bolt
8mm Lock Washer
8mm Flat Washer



Fig 14. Installation Completed

The instruction here is for your reference only. We strongly recommend the professional installer for best result. We are not responsible for any damage caused by the installation. Thank you for choosing our product!