

(6",5",4")RUNNING BOARD
FOR 2007-2018 Chevy/GMC Silverado/Sierra 1500/2500/3500 Regular Cab/(Incl. Diesel models with DEF tanks)
Rev:20181101

Installation Instructions for IB03DAI6 by APS Auto Parts Specialist Inc.

Application: FOR 2007-2018 Chevy/GMC Silverado/Sierra 1500/2500/3500 Regular Cab/
(Incl. Diesel models with DEF tanks)

Estimated Time: 1 to 2 hours



Disclaimer: Instructions intended for persons aged 18+ please do not attempt without adult supervision. Instructions are not intended to replace professional installation. Damage from improper installation, misuse or modification to the product voids the manufacturer's warranty.

PARTS LIST:

Item	QTY	Description	Item	QTY	Description
#1	2	Running Board(use for left or right)	#8	9	8mm Flat Washer
#2	1	Passenger/right Front Upper Bracket (PFS)	#9	9	8mm Lock Washer
#3	1	Passenger/right Front Lower Bracket (PFM)	#10	7	8mm Clip-On Nuts
#4	3	Mounting Brackets (DFM)	#11	16	M6 x 1 - 20mm T-Bolts
#5	1	8mm Bolt Plate	#12	16	M6 Flat Washers
#6	1	8mm Nylon Lock Nut (use w-bolt plate)	#13	16	M6 Nylon Lock Nuts
#7	9	8mm x 25mm Hex Bolt			

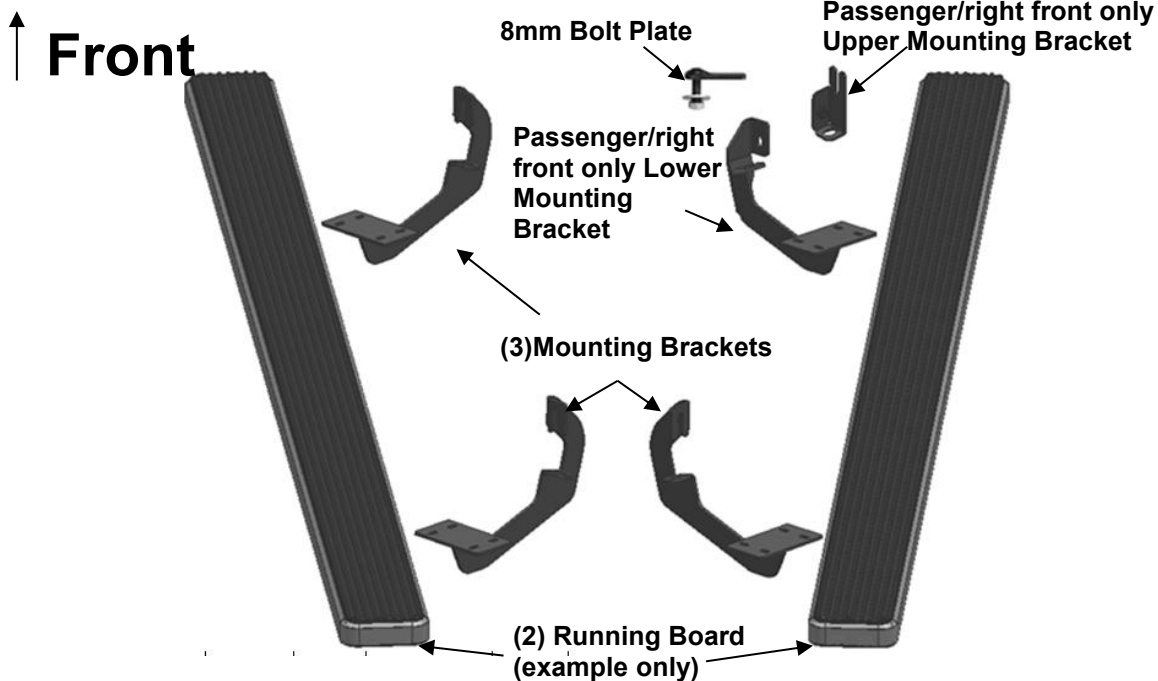

PROCEDURE:

REMOVE CONTENTS FROM BOX. VERIFY ALL PARTS ARE PRESENT. READ INSTRUCTIONS CAREFULLY BEFORE STARTING INSTALLATION. ASSISTANCE IS RECOMMENDED. ON MODELS WITH DEF TANK, SELECT A FLAT, LEVEL AREA FOR INSTALLATION.

1. Start the installation under the driver side of the vehicle. Locate the tabs along the bottom edge of the body, (pinch weld). Mounting Brackets will bolt to the front and rear mounting tabs approximately 23-3/4" apart, (Figure 1). Directly above each tab is a top mounting location on the side of the body panel. Hold a Bracket and/or Running board up in place to help determine the mounting holes to use along the body.
2. Determine the correct procedure for your model year and each Bracket location.

Bottom mounting location on the edge of the pinch weld.

Flat tab on pinch weld with factory installed weld nut:

Thread hex bolt into weld nut from the backside-down to clear paint from threads, (Figure 2).

Flat tab on pinch weld with hole:

Select (1) 8mm Clip Nut. Slide the Clip Nut over the tab with the nut facing up behind the tab, (Figures 3—5). Line up threaded nut with hole in tab. Repeat for each mounting location.

Top mounting location on the side of the body panel.

Models with factory installed threaded insert in body panel:

Thread 8mm Hex Bolt into threaded insert to clear paint as required, (Figures 2 & 3).

Large and small hole in side of body panel:

Remove the rubber plug from the larger hole, (Figure 4). Select (1) 8mm Clip Nut. Slide the Clip Nut into the larger hole. Line up the threaded nut with the smaller hole, (Figure 5).

3. Select (1) Mounting Bracket. **NOTE:** Bolt the Mounting Bracket to the Clip Nuts and/or the factory threaded holes with (2) 8mm Hex Bolts, (2) 8mm Lock Washers and (2) 8mm Flat Washers, (**Figures 6 & 7**). Snug but do not fully tighten the hardware.
4. Repeat **Steps 1—3** to install the remaining driver side Brackets, (**Figure 7**).
5. Select the Running Board. Slip (8) 6mm T-Bolts into each bottom channel (**Figure 16**). Carefully position the Running Board onto the (2) Mounting Brackets. **IMPORTANT:** Do not slide the Running Board on the Brackets or damage to the finish may result. Attach the Running Board to the Mounting Brackets with (4) M6 T-bolts,(4)M6 flat washers and (4)M6 nylon lock nuts, (**Figure 17**). Do not tighten hardware.
6. Level and adjust the Running Board and tighten all hardware. **NOTE: Torque all M6 nylon lock nuts to 7 lb-ft.**
7. Move to the passenger side of the vehicle. On the passenger side, determine if the vehicle is equipped with a plastic diesel exhaust fluid (DEF) tank, (**Figures 8 & 9**).

Models without DEF tank, skip to Step 8.

Models with DEF tank: The tank sits close to the side of the body. With specialized tools, the passenger front upper and lower Bracket can be installed but room is limited. It may be easier to drop the tank down to access the inner side of the body panel for upper bracket installation. Tank will not need to be removed, only dropped down for access to mounting location. **IMPORTANT:** If tank is full, it will be very heavy and assistance is highly recommended to avoid injury or damage to the vehicle or the tank. It is recommended that installation is performed when the DEF tank is low on fluid before dropping the tank.

- a. On models with plastic lower tray under the tank, remove the (3) hex bolts attaching the tray to the frame, (**Figure 8**), and remove the tray.
 - b. Release the tank filler hose. Release the plug for the sending unit on the top of the tank.
 - c. Support the tank with a floor jack. Place a smooth flat surface, (wooden block for example), between the floor jack and the tank to avoid damaging the plastic tank. Do not push up on the tank; only support the weight of the tank with the jack.
 - d. Remove the (2) bolts securing the tank straps to the vehicle, (**Figure 9**). Tilt the straps to release from the brackets. Slowly lower the tank until the top of the tank is almost visible. Use blocks or stands to support the tank while installing the front Upper and Lower Brackets.
 - e. Proceed to **Step 8**.
8. Locate the first tab on the edge of the pinch weld on the passenger side, (**Figures 2—4, 11 & 13**). Select the Upper Bracket, (**Figure 10**). Repeat **Steps 2 & 3** to attach the passenger front Upper Bracket to the side of the body panel, (**Figure 11**). Do not tighten hardware at this time.
 9. Line up the hole in the bottom of the Upper Bracket with the hole in the tab on the pinch weld.
 - a. **Models with a weld-nut:** Slide the Bracket over the weld-nut, (**Figure 11**). Attach the Lower Bracket to the bottom of the body and weld-nut with (1) 8mm x 25mm Hex Bolt, (1) 8mm Lock Washer and (1) 8mm Flat Washer, (**Figures 14 & 15**). Leave loose at this time.
 - b. **Models with flat tab and hole:** Insert the 8mm Bolt Plate down through the hole in the Upper Bracket and mounting tab, (**Figures 12 & 13**). Attach the Lower Bracket to the bottom of the body and Bolt Plate with (1) 8mm Flat Washer and (1) 8mm Nylon Lock Nut, (**Figures 14 & 15**). Leave loose at this time.
 10. Line up the side tab on the Lower Bracket with the threaded hole in the side of the Upper Bracket. Attach the Lower Bracket to the Upper Bracket with (1) 8mm x 25mm Hex Bolt, (1) 8mm Lock Washer and (1) 8mm Flat Washer, (**Figure 15**). Leave loose at this time. Repeat **Steps 1—3** for the (2) remaining passenger side Bracket installations.
 11. Repeat **Steps 5 & 6** to install the passenger Side Step (**Figure 17**).
 12. Once the Side Steps are installed and all hardware fully tightened, reinstall the DEF tank and cover, if equipped, as described in **Step 7**.
 13. Do periodic inspections to the installation to make sure that all hardware is secure and tight.

To protect your investment, wax this product after installing. Regular waxing is recommended to add a protective layer over the finish. Do not use any type of polish or wax that may contain abrasives that could damage the finish.

For Polished Finishes: Aluminum polish may be used to polish small scratches and scuffs on the finish. Mild soap may be used also to clean the Running Board.

For Black Finishes: Mild soap may be used to clean the Running Board.

Driver/Left Side Installation Pictured

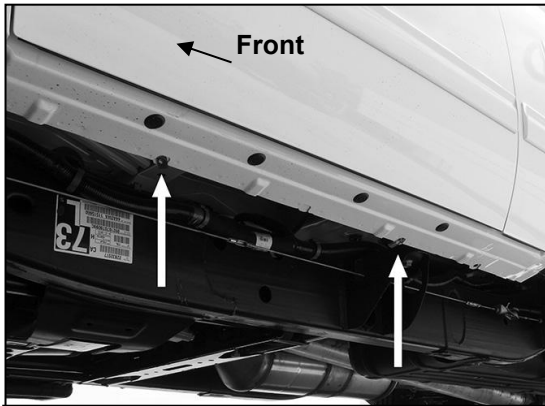

(Fig 1) Driver side (2) mounting locations

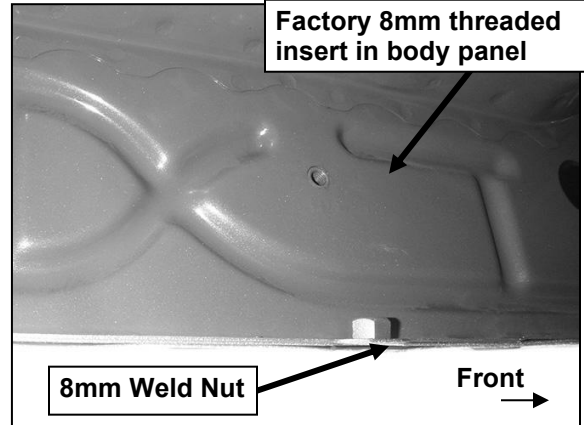

(Fig 2) Passenger side front mounting location

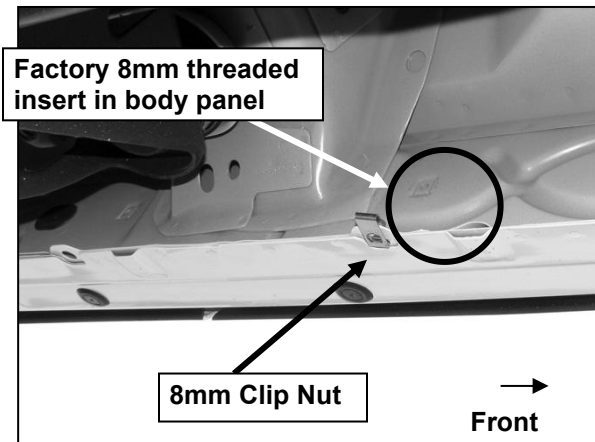

(Fig 3) Driver side 2nd mounting location

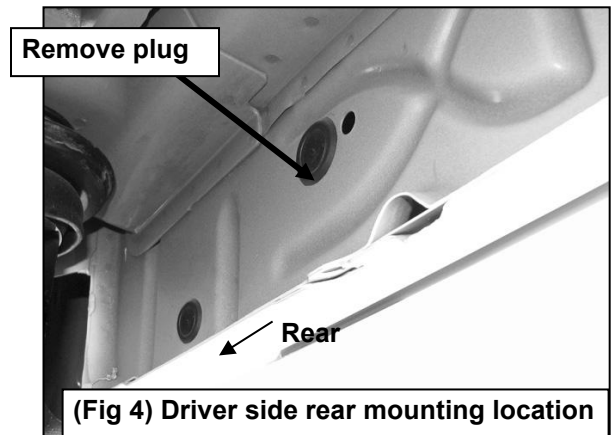

(Fig 4) Driver side rear mounting location

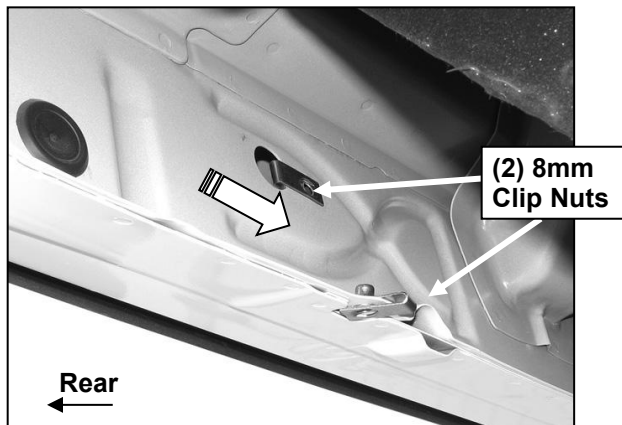

(Fig 5) Driver side rear mounting location

- (2) M8 x 25mm Hex Bolts
- (2) M8 Lock Washers
- (2) M8 Flat Washers

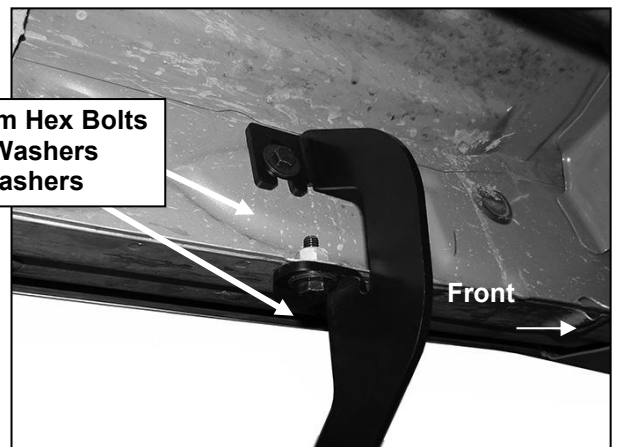

(Fig 6) Driver/left front bracket installed

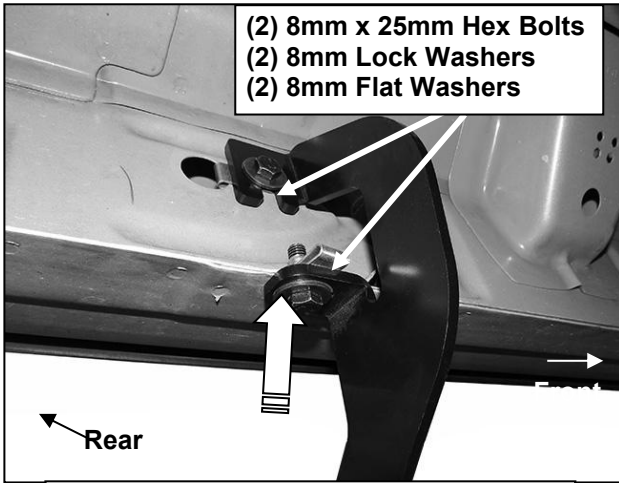

(Fig 7) Driver/left rear bracket installed

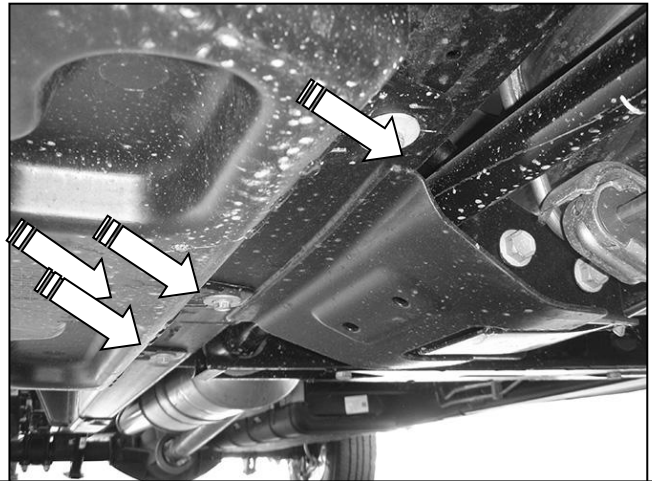

(Fig 8) Passenger side front pictured with DEF tank cover. Remove (3) hex bolts to remove cover



(Fig 9) Passenger side DEF tank and cover

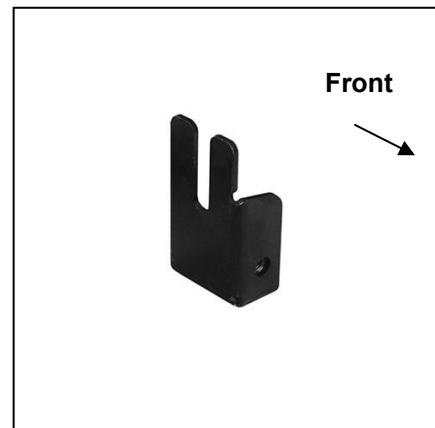

(Fig 10) Passenger/right Front Upper Bracket (all models)

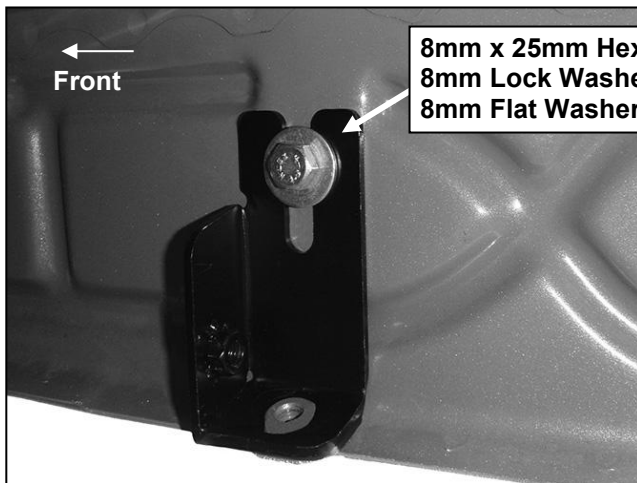

(Fig 11) Slide Upper Bracket over weld nut if equipped-also see Figure 2



(Fig 12) 8mm x 35mm Bolt Plate

Passenger/right Side Installation Pictured

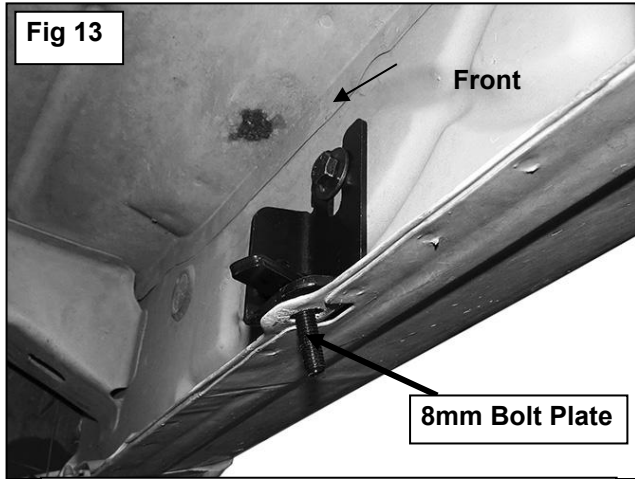
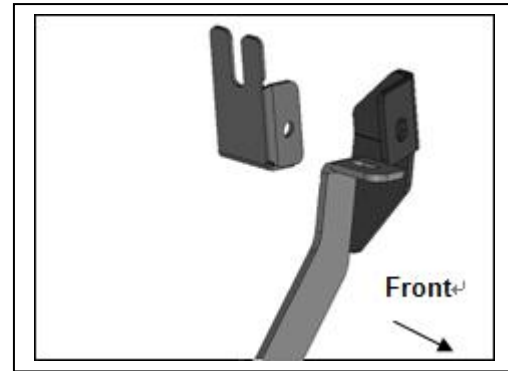

Fig 13

8mm Bolt Plate

On models with flat tab (see Fig 3, 4 and 15), insert 8mm Bolt Plate (Fig 12) down through Upper Bracket and mounting tab



(Fig 14) Passenger/right Front Lower Bracket (all models)

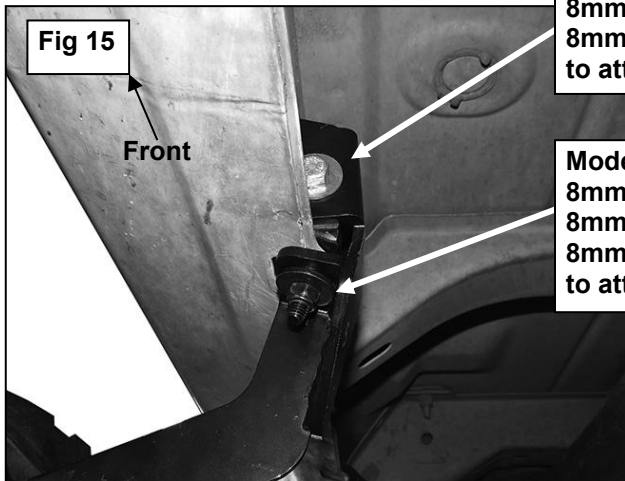

Fig 15

Front

On models with flat tab and 8mm Bolt Plate (see Fig. 13) use:
 8mm Flat Washer
 8mm Nylon Lock Nut
 to attach Lower Bracket to Bolt Plate

Models with weld nut on tab use:
 8mm x 25mm Hex Bolt
 8mm Lock Washer
 8mm Flat Washer
 to attach Lower Bracket to weld nut



(Fig 16) Slip 6mm T-bolts into the bottom channel

(4)M6 T-bolts
 (4)M6 Flat Washers
 (4)M6 nylon Lock nuts

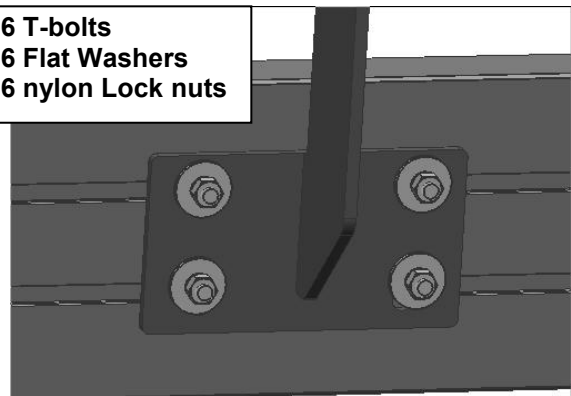

(Fig 17) Passenger/right bracket installed