



INSTALLATION GUIDE

PART NUMBER: 153712-153713

LIFT SUSPENSION SYSTEM

RAM 1500 2WD / 4WD | 2019+

Ride heights will vary depending on the Belltech lift kit selected

153712: 6" to 8"

153713: 6" to 9"

****EXCLUDES CLASSIC AND eTORQUE MODELS****

300 W. PONTIAC WAY. CLOVIS, CA 93612

PHONE: 800-445-3767 | EMAIL: INFO@BELLTECH.COM

THANK YOU

Thank you for choosing our high quality Belltech product. We have spent a great deal of time developing our line of products so that you will receive maximum performance with minimal difficulty during installation. Soon your vehicle will be on the road looking and feeling much improved.

Please take a moment to read all instructions and warnings prior to installation of your new Belltech product and before operating your vehicle. If you have any questions or concerns regarding any step in the installation process, please do not hesitate to call or email our customer support specialists who are trained to help you through any portion of this process.

Before You Begin:

It is of the utmost importance that you confirm all of the components listed on the parts list is in the kit. You can find this list located on the last page(s) of your instructions. Do not begin installation if any part is missing. Instead, please call our Belltech customer service specialists.

Belltech Customer Support:

Phone: 1-800-445-3767

Email: info@belltech.com

Safety Information:

Warning: Do not work under a vehicle supported only by a jack. Place support stands securely under the vehicle in the manufacturer's specified locations unless otherwise instructed.

Proper use of safety equipment and eye/face/hand protection is absolutely necessary when performing any of the following instructions.

We strive for an exceptional experience for all our valued customers. If for any reason you need assistance with your Belltech products, please do not return the product to the store you purchased from, but rather call our dedicated customer service experts, from 7am to 5pm PST.

We recommend that a qualified mechanic, at a properly equipped facility, perform this installation.

It is very helpful to have an assistant available during installation.

Before Driving Your Vehicle:

It is important to double check all brake hoses, cables, and other components to be sure there is no interference. You must also check for wheel/tire to chassis/body interference. If any issues are found, review your installation instructions to be sure no steps were missed and any problems are corrected.

Make sure your vehicle is aligned immediately following installation.

Check all hardware and re-torque at intervals for the first 10, 100, and 1000 miles.

Some of Belltech's products are designed to improve your vehicle's off-road performance. Leveling/lifting your vehicle may result in an altered center of gravity. It is crucial to use extreme care when operating your vehicle to prevent rollover and/or loss of control.

Any changes in your vehicle's suspension may result in transformed handleability. Please test-drive your vehicle in a remote location so you can become accustomed to the revised driving characteristics.

Perform headlight check and adjustment.

Failure to drive any modified vehicle in a safe manner may result in harm or death.

Never operate your modified vehicle under the influence of drugs, alcohol, or lack of adequate sleep.

Always wear your seatbelt.

PRODUCT NOTES

Please take note of vehicle or wheel/tire fitments that may affect you before, during, or after the installation process.

FITMENT NOTE:

RAM trucks with OEM 22" wheels require a larger bore steering knuckle due to a larger wheel bearing assembly, as a result this lift kit will not fit these OEM 22" wheels. Please check for build sales code WPM or WPZ on your RAM to see if this might apply to you

FITMENT NOTE:

Please take a look under your vehicle's hood. If your vehicle contains a DC charger as shown, you have an eTorque model and our kit will not work with your truck. If this is the case, please contact the vendor you purchased your Belltech kit from to begin the return process



Not all possible wheel sizes and backspacing can be tested. Cautiously check wheel assembly to spindle, suspension component, and fender/body clearance before tightening lug nuts and rotating the wheel assembly. Belltech is not responsible for any wheel, tire, suspension component, and/or body damage caused by failure to check for interference

FITMENT GUIDE

Minimum wheel specs: 18" diameter, 5" Backspacing

Maximum recommended tire size: 37"x12.5" at 6" lift with 5" wheel backspacing.



DIFFICULTY:

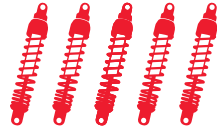

INSTALLATION TIME:

6-8 Hours + Alignment

RECOMMENDED TOOLS:

- Properly rated floor jack
- Support stands
- Wheel chocks
- Metric and standard socket wrench set
- Metric and standard wrench set
- T-30 Torx bit
- 5mm hex key
- Dead blow hammer
- Safety glasses
- Tape measure
- Marking Pen

SPECIALTY TOOLS:

- High quality spring compressor
- Torque wrench up to 200lbs
- Reciprocating saw
- Angle grinder with metal cutting wheel

INSTALLATION PREPARATION:

Before beginning the installation process, measure the hub to fender heights for your vehicle and record them in the “Before” section. After your vehicle has been modified, record the new measurements in the “After” section. This way you can compare the resulting height to the original. When taking the measurements, measure vertically from the center of the wheel to the inner edge of the fender.

Before:

LF: _____

RF: _____

LR: _____

RR: _____



After:

LF: _____

RF: _____

LR: _____

RR: _____

JACKING, SUPPORTING, AND PREPARING THE VEHICLE

1. Park your vehicle on a smooth, level, concrete or seasoned asphalt surface.
2. Block the rear wheels of the vehicle using wheel chocks. Make sure the vehicle's transmission is in "PARK" (automatic) or 1st gear (manual).
3. Activate the parking brake.
4. Loosen, but do not remove, the front wheel lug nuts.
5. Lift the front of the vehicle off the ground using a properly rated floor jack. Lift the vehicle so the front tires are approximately 6-8 inches off the ground.
6. Place support stands rated for the vehicles weight. The stands should be positioned in the factory specified locations. (Refer to owners manual). Prior to lowering the vehicle onto stands, make sure the support stands will contact the chassis. It is very important that the vehicle is properly supported to prevent any harm to ones self or to the vehicle.
7. Lower the vehicle slowly onto the stands.
8. Remove the front wheels.



Technician reminder:

Never work under a vehicle supported only by a jack. It is necessary to place support stands securely under the vehicle in the manufacturer's specified locations unless otherwise instructed.

FRONT REMOVAL

9. Remove the factory skid plate and plastic guards if equipped.
10. Remove the sway bar and end links from the vehicle.

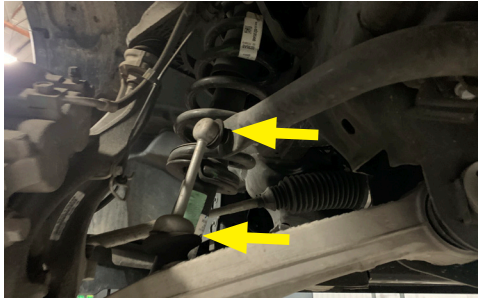

11. Loosen the jam nuts on the tie rods. Remove the tie-rod nuts from spindles. Strike the side of the mount with a hammer, or use a puller to dislodge the tie rod end. Remove outer tie rod from inner tie rod.



12. Remove all mounting points for the brake line and ABS sensor wire from the upper control arm and spindle.
13. Undo the brake caliper mounting bolts located at the back of the spindle. Hang the calipers on the frame to prevent stretching of the lines using large zip ties or hangers.



14. Remove the rotor using a T-30 Torx.
15. Remove the ABS sensor from the steering knuckle using a 5mm Allen.
16. (4WD only) Remove the axle nut from the hub. Dislodge the axle pin from the hub using a hub puller if needed.



FRONT REMOVAL CONTINUED

17. Loosen but do not fully remove the upper ball joint nut. Strike the spindle on the designated bosses to help separate the upper control arm from the spindle.

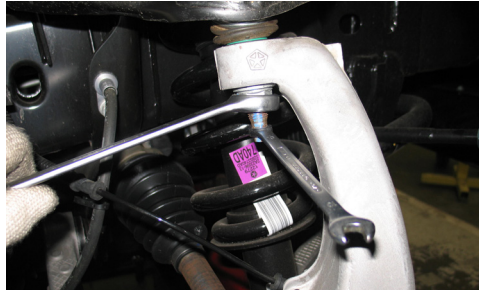

18. Loosen but do not fully remove lower ball joint nut and strike it on the designated areas to separate from the lower control arm.



19. Remove the bottom OEM strut fork bolt.

20. Support the spindle, remove both ball joint nuts, and remove spindle from vehicle.

21. Remove the lower control arm bolts and remove the control arms from the vehicle.

22. Remove the OEM strut by loosening the top three bolts in the strut tower.



23. Remove the OEM axles. A hammer or pry bar may be needed to dislodge the axles from the differential.

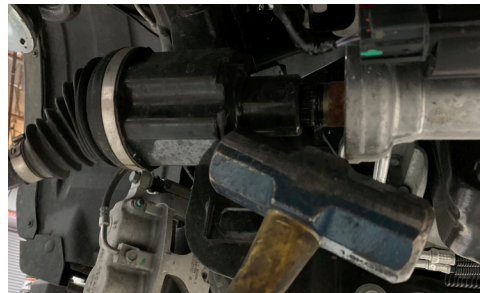

FRONT REMOVAL CONTINUED

4WD ONLY - OEM DIFFERENTIAL REMOVAL

24. Unbolt the four bolts on the rear crossmember near the front differential to remove the rear crossmember from between the mounting points.



25. Disconnect the electronics connected to the differential before unbolting or lowering it.
26. Support the differential from below.
27. Unbolt and disconnect the driveshaft from the differential.
28. Locate all the bolts that mount the differential to the frame. Two bolts are located on the passenger side. Two more bolts are located above the differential; the last three bolts are located towards the back of the differential on the driver side.
29. Remove the differential, being careful not to damage surrounding components.
30. Using the outer edge of the OEM alignment tabs on the drivers rear lower control arm mount, measure 19.00mm (0.75") towards the center of the vehicle and mark vertically using a paint pen. Do this on the front and rear of the bracket, and connect the lines across the top.



31. Use a reciprocating saw or angle grinder to cut along the painted line.
32. Once the cut is complete; grind any sharp edges and paint any exposed metal with spray paint to prevent future rust.



FRONT INSTALLATION

4WD ONLY - INSTALLING BELLTECH 153712-104 DIFFERENTIAL BRACKETS

33. To install the differential drop brackets, use the OE hardware for the front bracket and the supplied hardware on the rear bracket. Keep the bolts loose, allowing slight movement in the brackets to ease with installing the differential.
34. Lift the differential back into the vehicle and install it into the differential drop brackets using the supplied hardware for the front and OE hardware for the back mount.



35. On the passenger side, flip and re install the OEM harness bracket onto the differential bracket and route the wires as shown. Release harness retainer clips as needed to get proper slack in the wires. Tighten all the hardware connecting the differential to the bracket, then the brackets to the frame. Use OE torque spec for all differential hardware.



36. Reconnect all remaining differential electronics.
37. Trim the plastic guard underneath the shift cable on the left side of the transmission for driveline clearance as shown in the image below. Sand the edges to remove burrs and sharp edges.
38. Using supplied hardware, install the supplied drive line spacer between the front differential and the front drive shaft.

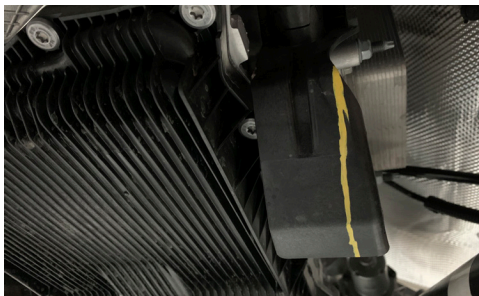

FRONT INSTALLATION CONTINUED

39. Install the new front and rear crossmembers using the supplied hardware. Torque to 180 ft lbs.
40. Install the lower control arms into the crossmembers using OEM hardware. Hand tighten. Do not torque yet.



41. Transfer the hubs and brake backing plates from the OEM spindles into the lifting spindles. Be sure the backing plate and ABS port are installed in the right orientation.



42. **4WD ONLY** - Reconnect the CV axles into the differential. Push onto the splined shaft until you feel it pop into place.
43. **4WD ONLY** - Slide the lifting spindle assembly onto the CV axle shaft and use the axle nut to hold in place.



44. Place the spindle on the lower ball joint and hold in place using the lower ball joint nut.
45. Attach upper control arm Ball joint to the spindle. A jack may help support the weight of the spindle. Torque the upper and lower ball joint nuts to OE specs.



FRONT INSTALLATION CONTINUED



Installation Note:

For Strut Spacer Installation:

- Please refer to the included instructions for strut spacer 153712-120.

For Trail Performance Strut or Coilover Installation:

- Please refer to the included instructions for strut 28020 or coilover 15305.

46. 4WD ONLY - Ensure that the axle has aligned correctly into the hub. Install and torque the Axle nut onto the CV axle.

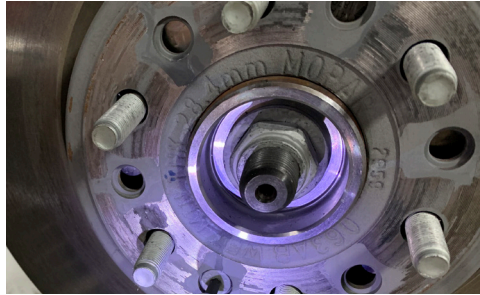

47. Reinstall the ABS Line, Route the wire behind the brake backing plate and under the steering arm on the spindle.

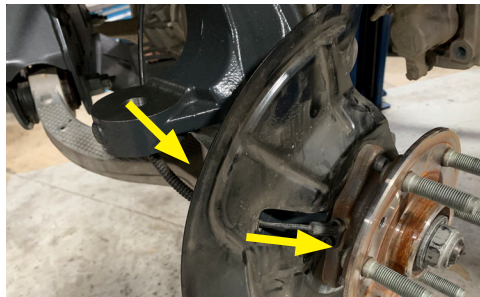

Technician reminder:

Please follow proper safety precautions when removing brake lines. Brake fluid is highly corrosive and should be contained in any way possible.

48. Unbolt front brake line brackets from the frame.

49. Disconnect the soft brake line from the caliper and upper compression fitting.

50. There are 2 possible extended brake lines that may be included with your kit. One uses a factory style mounting bracket and the OE bolt, and the other uses the included retaining clip.



51. Install the new brake line onto the vehicle. If necessary, slightly open the hole in the frame for proper fitment.

52. Install the rotors and brake calipers onto the lifting spindle. Install the rotor locating bolt.

FRONT INSTALLATION CONTINUED

53. Using an angle grinder, cut 1/4" from the inner tie rods. It will be helpful to keep the jam nut on the threads and to run it back out over the cut threads to ensure the threads are aligned properly after cutting.



54. Install the new outer tie rods to the cut inner tie rods, then into the spindle. Torque to 41 ft lbs. + 180° turn.

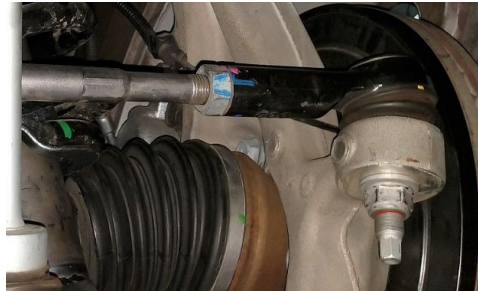

Installation Note:

Sway bar or sway bar drop down bracket installation:

Please refer to the included instructions for your selected sway bar kit. 9938 or 5437. If your kit came with LK74000 (sway bar drop down brackets), and did NOT come with a Belltech sway bar, please reference the last page of this instruction for steps to install your OE sway bar using your new Belltech sway bar drop down brackets.

55. Install the new Belltech skid plate using the provided hardware. Torque to 41 ft lbs.

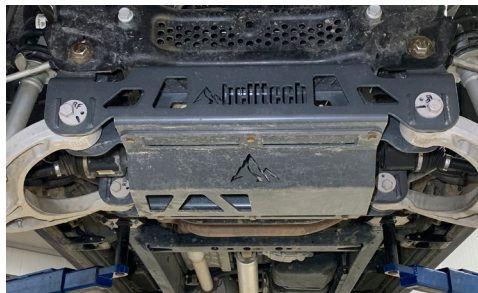

56. Tighten all installed hardware to OEM specs.
57. **IMPORTANT - Perform a factory recommended brake bleeding procedure. The rear brakes will not be disconnected, a full bleed should be performed at this time. Failure to properly bleed brakes will result in brake failure.**
58. Reinstall the wheels and lower the vehicle to the ground. Torque control arms to 74 ft lbs. + 145°. Torque lug nuts to 130 ft lbs.

REAR REMOVAL

59. Jack up the rear of the vehicle. Place jack stands under the frame rails and lower onto jack stands letting the rear suspension hang.

60. Disconnect brake line brackets from each side of the frame.



61. Disconnect ABS wire bracket from crossmember above the differential with a 10mm socket.



62. Using a pry tool, disconnect the 2 rear plastic clips on the hard brake line on either side to separate them from the frame, and allow them to move downward to accommodate for the lift.



63. Using an 8mm wrench, remove rear fender liners.

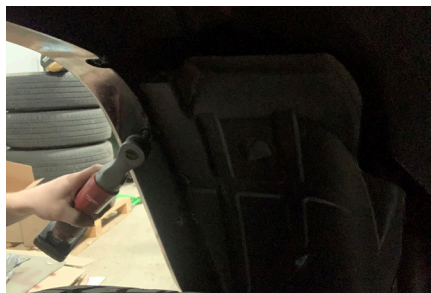

64. Supporting the differential with a floor jack, remove the rear shocks. The lower hardware will be reused.

65. Remove lower Track bar bolt and OE swaybar end links.

66. Lower axle and remove both rear springs and rubber isolators.

REAR INSTALLATION

To install the rear control arm brackets, either support the axle with multiple stands, or work one side at a time.

67. Loosen but do not remove the axle-end control arm bolts.



68. Remove the frame-end control arm bolts. These will not be reused.

69. Install control arm drop bracket onto the frame with the supplied M16 hardware and crush tubes. Do not tighten yet.



70. Install the supplied M14 bolt with washers through the hole in the front of the bracket and torque to 90ft Lbs.

71. Torque both M16 bolts to 180 ft lbs.

72. Install the control arms into the drop bracket using supplied M16 hardware. Do not tighten yet.

73. Repeat steps 67-72 on the opposite side if working on each side separately.

74. 153712BK KIT ONLY - For rear spring spacers, install them into the upper spring seats on the frame using supplied M8 nuts



75. Lower the axle enough to install the new rear lift springs with rubber isolators. For kit **153712BK**, please reinstall the OE springs.

76. Raise the axle up and install the new rear shocks with OE bolts on the bottom, torque to 103 ft lbs. and using the provided nut at the top torque to 35 ft lbs.

REAR INSTALLATION CONTINUED

77. Install the rear brake line drop brackets to each side of the frame using OE hardware. Install the brake lines on the brackets using supplied M8 hardware.



78. Install the central ABS wire harness drop bracket to the frame with OE hardware. The bent locating tabs face toward the rear of the truck. The 90 degree bend faces the passenger side.

79. Install the OE ABS wire harness to the lowering bracket using supplied M6 hardware.



80. Remove the plastic wire retainer from the driver side of the track bar bracket on the axle. Drill the hole out with a 1/2" drill bit.

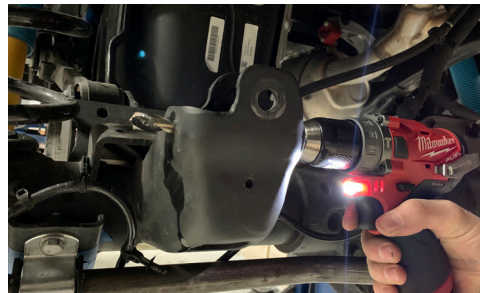

81. Install the track bar relocation bracket onto the axle. First install the M12 bolt with no washer on the head from the inside of the bracket through the hole drilled out in the previous step. Install the washer and nut on the M12 bolt. Loosely Install the provided M14 hardware and crush sleeve in the original track bar hole.



82. First, torque the M12 nut to 80 ft lbs, then torque the M14 bolt to 100 ft lbs

83. Install the track bar to the bracket using OE hardware. It may help to bend the flag on the OE nut to allow it to hold onto the bracket and not spin. Do not torque yet.

REAR INSTALLATION CONTINUED

84. Install the new extended length sway bar end links using OE bolt up top, torque to 41 ft lbs. Using the provided nut at the bottom torque to 66 ft lbs.
85. Remove OE bump stops by pulling them out of their retaining cup.



86. Install new bump stops and spacers with the provided hardware as shown in the image below. Insert the bolt from the bottom.



87. Install the wheels if they were removed and lower rear of the vehicle onto the ground.
88. Torque the wheel lug nuts to 130 ft lbs.
89. Torque all control arm bolts to 111 ft lbs. + 110° turn.
90. Torque the track bar axle bolt 127 ft lbs. and the track bar frame nut to 96 ft lbs.
91. Reinstall the rear fender liners.
92. Double check the torque of all components and ensure there is no binding or pulling of the brake lines and electrical cables.

SWAY BAR DROP DOWN BRACKET INSTALLATION

FOR USE WITH THE OE SWAY BAR ONLY

1. Install the supplied sway bar drop brackets on the frame using the OE sway bar hardware. Install the brackets with the solid side facing outward.



2. Install the sway bar assembly on the drop down brackets using the provided hardware in the 153712I-777 hardware kit. Torque all hardware to 30 ft lbs.
3. Reference back to step 55 of the main instructions.

FINALIZING THE INSTALLATION

1. Re-install the wheels and tighten the lug nuts.
2. Lift the vehicle and remove the support stands.
3. Carefully lower the vehicle onto the flat ground.
4. Torque the lug nuts to manufacturer's specifications.
5. Check that all components and fasteners have been properly installed and torqued.
6. Re-read and perform all tasks in the "Before Driving Your Vehicle" section of page 1 of your instructions.

THANK YOU FOR CHOOSING BELLTECH.

You are now a part of the Belltech family and we are eager to catch a glimpse of your newly modified vehicle. Give us a shout out and let us know how much you love our product. Don't forget, we offer other Belltech related merchandise for you and your vehicle on our website www.belltech.com

VISIT OUR SITE

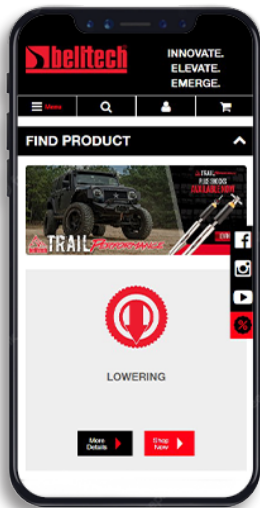

[belltechsuspension](https://www.facebook.com/belltechsuspension)



[Belltech Suspension](https://www.youtube.com/BelltechSuspension)



[@belltechsuspension](https://www.instagram.com/belltechsuspension)

If you have any questions, concerns, or warranty related issues regarding your Belltech product, please call or email our experienced customer service specialists.

Belltech Customer Support:

Phone: 1-800-445-3767

Email: info@belltech.com

KIT CONTENTS



LK71000		
Part number	Description	Qty
153712A-777	Hardware Kit	1
153712-101-992	Front Crossmember	1
153712-102-992	Rear Crossmember	1

LK7001A		
Part number	Description	Qty
153712-110	Outer Tie Rod	2
4923-001	Bump Stop	2
153712-225-99	Brake Line Bracket	1
153712-226-99	Brake Line Bracket	1
153712-227-99	Brake Line Bracket	1
153712-203	Bump Stop Extension	2
153712-207-99	Control arm Bracket Crush Sleeve	4
153712C-777	Hardware Kit	1
153712D-777	Hardware Kit	1
153712E-777	Hardware Kit	1
153712F-777	Hardware Kit	1
153712G-777	Hardware Kit	1
153712H-777	Hardware Kit	1
153712-130	Front SS Brake Line Kit	1

LK71001		
Part number	Description	Qty
153712-205-99	Driver Rear Control Arm Drop	1
153712-206-99	Passenger Rear Control Arm Drop	1
153712-223-99	Track Bar Relocator	1
LK7001A	Sub Kit - A	1
153712-108-992	Skid Plate	1
153712-216	Rear Swaybar End Link	2

LK2652		
Part number	Description	Qty
153712-103L	Driver Side Spindle	1
153712-103R	Passenger Side Spindle	1

LK30001 (4WD only)		
Part number	Description	Qty
153712-104A-99	Driver Rear Control Arm Drop	1
153712-104B-99	Rear Differential Drop	1
153712-140-95	Drive Line Spacer	1
153712B-777	Hardware Kit	1

The supplied shock, spring, and/or spacer sets will vary depending on the stage selection

KIT CONTENTS

HARDWARE KIT - 153712A-777

Part number	Description	Qty
110264	Bolt M18-2.5x140	1
110265	Nylon Lock Nut M18-2.5	1
153712-101W-99	Centering Washer M18	1

HARDWARE KIT - 153712B-777

Part number	Description	Qty
110225	Bolt M12-1.75x30	3
110282	Bolt M12-1.75x45	2
110243	Nylon Lock Nut M12-1.75	7
112151	Bolt M12x1.75	6
110228	Washer M12	18

HARDWARE KIT - 153712C-777

Part number	Description	Qty
110218	Bolt M16-2.0x120	8
110242	Nylon Lock Nut M16-2.0	8
110219	Washer M16	16
110283	Bolt Flanged M14-2.0x45	2
110222	Nylon Lock Nut M14-2.0	2
110223	Washer M14	2

HARDWARE KIT - 153712D-777

Part number	Description	Qty
110246	Bolt M10-1.75x60	2
112292	Nylon Lock Nut M12-1.5	2
110228	Washer M12	4

LK74000

Part number	Description	Qty
153712I-777	Hardware Kit	1
153712-113L-99	Left Sway bar Drop Down	1
153712-113R-99	Right Sway Bar Drop Down	1

HARDWARE KIT - 153712E-777

Part number	Description	Qty
112103	Bolt M14-1.5x90	1
110292	Nylon Lock Nut M14-1.5	1
110223	Washer M14	2
110225	Bolt M12-1.75x30	1
110243	Nylon Lock Nut M12-1.75	1
110228	Washer M12	1

HARDWARE KIT - 153712F-777

Part number	Description	Qty
110232	Bolt M8-1.0x16	2
110233	Nylon Lock Nut M8-1.0	2
110245	Washer M8	4
110234	Bolt M6-1.0x16	1
110235	Nylon Lock Nut M6-1.0	1
110117	Washer M6	2

HARDWARE KIT - 153712G-777

Part number	Description	Qty
112142	Bolt Serrated Flanged M10-1.5x25	6

HARDWARE KIT - 153712H-777

Part number	Description	Qty
110246	Bolt Socket Head M10-1.5x130	2
110280	Nylon Lock nut M10-1.5	2
110239	Washer M10	4

HARDWARE KIT - 153712I-777

Part number	Description	Qty
110230	Bolt M10 x 1.25—25MM	2
110244	Nut (Nylock) M10-1.25	2
110239	Washer Flat M10	4



INSTALLATION GUIDE

PART NUMBER: 28020
FRONT LIFTING STRUT
RAM 1500 2WD / 4WD | 2019+

****NEW GENERATION MODELS ONLY****

6" TO 8" ADJUSTABLE RIDE HEIGHT

300 W. PONTIAC WAY. CLOVIS, CA 93612
PHONE: 800-445-3767 | EMAIL: INFO@BELLTECH.COM

THANK YOU

Thank you for choosing our high quality Belltech product. We have spent a great deal of time developing our line of products so that you will receive maximum performance with minimal difficulty during installation. Soon your vehicle will be on the road looking and feeling much improved.

Please take a moment to read all instructions and warnings prior to the installation of your new Belltech product and before operating your vehicle. For any questions or concerns regarding the steps in the installation process, please do not hesitate to call or email our customer support team who are trained to help you through any portion of this process.

Before You Begin:

It is of the utmost importance that you confirm all of the components listed on the parts list is in the kit. You can find this list located on the last page(s) of your instructions. Do not begin installation if any part is missing. Instead, please call our Belltech customer service specialists.

Belltech Customer Support:

Phone: 1-800-445-3767

Email: info@belltech.com

Safety Information:

Warning: Do not work under a vehicle supported only by a jack. Place support stands securely under the vehicle in the manufacturer's specified locations unless otherwise instructed.

Proper use of safety equipment and eye/face/hand protection is absolutely necessary when performing any of the following instructions.

We strive for an exceptional experience for all our valued customers. If for any reason you need assistance with your Belltech products, please do not return the product to the store you purchased from, but rather call our dedicated customer service experts, from 7am to 5pm PST.

We recommend that a qualified mechanic, at a properly equipped facility, perform this installation.

It is very helpful to have an assistant available during installation.

Before Driving Your Vehicle:

It is important to double check all brake hoses, cables, and other components to be sure there is no interference. You must also check for wheel/tire to chassis/body interference. If any issues are found, review your installation instructions to be sure no steps were missed and any problems are corrected.

Make sure your vehicle is aligned immediately following installation.

Check all hardware and torque at intervals for the first 10, 100, and 1000 miles.

Some of Belltech's products are designed to improve your vehicle's off-road performance. Leveling/lifting your vehicle may result in an altered center of gravity. It is crucial to use extreme care when operating your vehicle to prevent rollover and/or loss of control.

Any changes in your vehicle's suspension may result in transformed handleability. Please test-drive your vehicle in a remote location so you can become accustomed to the revised driving characteristics.

Perform headlight check and adjustment.

Failure to drive any modified vehicle in a safe manner may result in harm or death.

Never operate your modified vehicle under the influence of drugs, alcohol, or lack of adequate sleep.

Always wear your seatbelt.



DIFFICULTY:

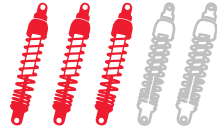

INSTALLATION TIME:

1-2 Hours Per
Strut +Alignment

RECOMMENDED TOOLS:

- Properly rated floor jack
- Wheel chocks
- Metric socket wrench set
- Metric wrench set
- Tape measure
- Marking Pen
- Dead blow hammer

SPECIALTY TOOLS:

- Torque wrench up to 200 ft lbs.
- Spring compressor
- Panel popping tool

FITMENT NOTE:

*** Belltech strut 28020 is designed to be used with lift kit 153712. If you are utilizing this strut with an alternate or competitor brand lift kit, use the provided ring chart on page 7 as a reference only***

INSTALLATION PREPARATION:

Before beginning the installation process, measure the hub to fender heights for your vehicle and record them in the “Before” section. After your vehicle has been modified, record the new measurements in the “After” section. This way you can compare the resulting height to the original. When taking the measurements, measure vertically from the center of the wheel to the inner edge of the fender.

Before:

LF: _____

RF: _____

LR: _____

RR: _____

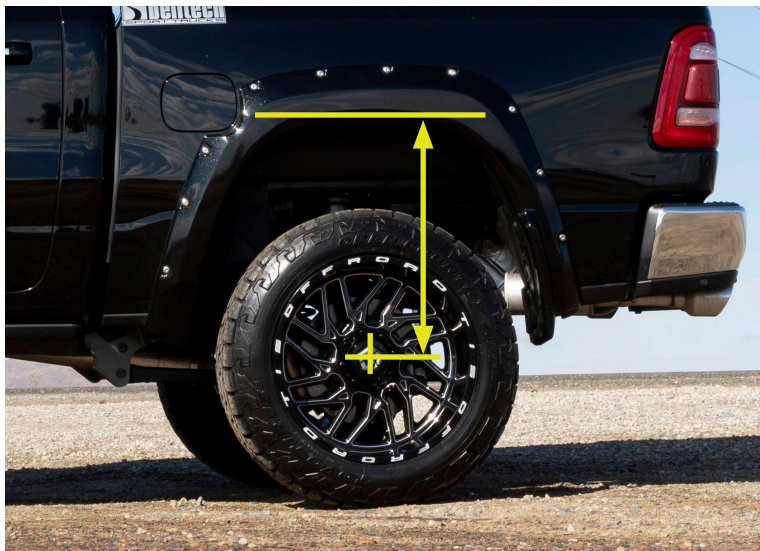

After:

LF: _____

RF: _____

LR: _____

RR: _____

JACKING, SUPPORTING, AND PREPARING THE VEHICLE

1. Park your vehicle on a smooth, level, concrete or seasoned asphalt surface.
2. Block the rear wheels of the vehicle using wheel chocks. Make sure the vehicle's transmission is in "PARK" (automatic) or 1st gear (manual).
3. Activate the parking brake.
4. Break loose, but do not spin the wheel lug nuts to ease in removal when the wheels are in the air.
5. Lift the front of the vehicle off the ground using a properly rated floor jack. Lift the vehicle so the front tires are approximately 6-8 inches off the ground.
6. Place support stands rated for the vehicles weight. The stands should be positioned in the factory specified locations. (Refer to the owners manual). Prior to lowering the vehicle onto stands, make sure the support stands will contact the chassis. It is very important that the vehicle is properly supported to prevent any harm to ones self or to the vehicle.
7. Lower the vehicle slowly onto the support stands.
8. Remove the front wheels.



Technician reminder:

Never work under a vehicle supported only by a jack. It is necessary to place support stands securely under the vehicle in the manufacturer's specified locations unless otherwise instructed.

OEM STRUT REMOVAL

9. Use an 18mm socket to remove the lower sway bar end link nut from the lower control arm.



10. Remove the tie rod nut from the spindle. Strike the side of the mount with a dead blow hammer or use a puller to dislodge the tie rod end.



11. Remove all mounting points for the brake line and ABS sensor wire from the upper control arm and spindle.
12. Remove the brake caliper mounting bolts located at the back of the spindle. Hang the calipers on the frame using large zip ties or hangers to prevent over stretching the lines.



OEM STRUT REMOVAL CONTINUED

- Loosen but do not fully remove the upper ball joint 21mm nut. Strike the spindle at the designated bosses to help separate the upper control arm from the spindle.

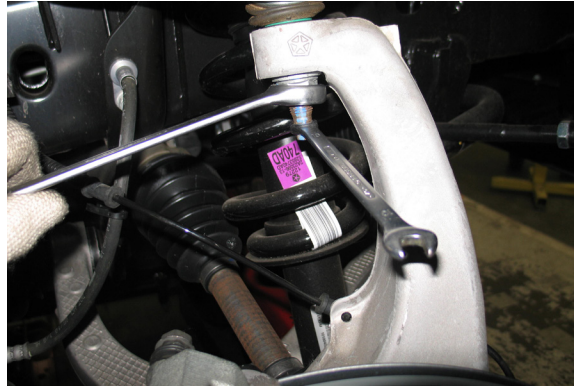

- Remove the bottom OE strut fork bolt using both a 21mm and a 24mm wrench.



- Using a panel popping tool, detach the harness clip front the top mount studs.



- Remove the three upper strut nuts using a 15mm wrench.
- Hold the spindle assembly while pushing down on the lower control arm, dislodging the bottom strut assembly from the lower control arm and remove it from the vehicle.



Technician reminder:

Ensure the brake lines and ABS wires are not over extended or damaged during the removal of the strut.

OEM STRUT DISASSEMBLY

18. Mount the strut assembly in a spring compressor fixture. To ease the installation of the new strut, mark the position of the top mount in relationship to the upper spring isolator and strut body.



Technician note:

The installation photograph shown was taken at a professional installation shop. It is important to use a spring compressor to compress the spring before removing the top mount bolt. Failure to do so may result in serious injury.



19. Compress the spring until tension is relieved from the strut.
20. Hold the strut shaft from spinning and remove the top center nut from the strut. Support the shock as the nut is removed as it will fall if not supported.
21. Remove the top mount and upper spring seat to use with your new Belltech strut later.
22. Remove the OEM strut from the compressed spring fixture.
23. Remove the bump stop if stuck in the dust boot.



BELLTECH STRUT ASSEMBLY

24. The strut is delivered as shown below. Remove the Nyloc nut from the top of the Belltech strut to proceed.



Technician note:

When lifting your vehicle more than 1", OE camber may not be achievable. After installation a final shop alignment procedure is recommended to minimize tire wear.

25. Using the tables below as reference, add the needed lift rings to reach the desired height.

2019+ RAM 1500			
Lift (Inches)	8mm Ring	16mm Ring	15mm Packer
8"	2	2	2
7"	2	1	1
6"	2	0	0
0"	0	0	0



Technician note:

Strut 28020 may include an extra 10mm ring, if so, place it on the strut housing first, then use the following chart to set the desired ride height. If a half inch lift height increment is desired, add one 8mm ring from the next lowest increment in the table above.

26. Install the spring perch onto the strut. Do not install the spring perch upside down.

BELLTECH STRUT ASSEMBLY CONTINUED



Ventilation Disk Installation Warning:

When assembling the Belltech shock/strut, make note of the orientation of the supplied Belltech ventilation disk. It has two sides: a flat side and an air-channeled side. The air-channeled side **MUST** be facing downward toward the shock/strut and the flat side toward the bump stop (See figures 1A and 1B).

Failure to do this, will result in shock/strut damage.

23. Slide the vent disk on the strut rod. Ensure the air-channeled side facing down as shown in the images below.

Air-channels face down toward strut

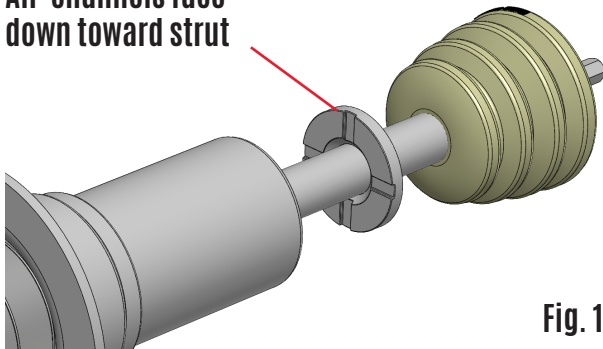

Fig. 1A

Flat surface faces up toward bump stop

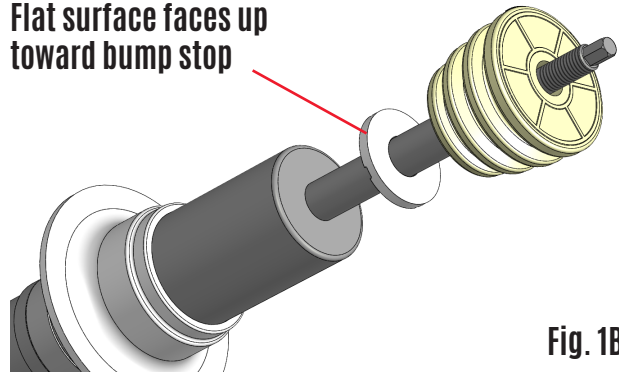

Fig. 1B

24. Slide the required packers onto the strut rod.



Technician note:

Belltech uses packers to maintain the correct bump stop engagement at various height ranges. Using the appropriate packer will prevent excessive body roll. If a packer is needed, according to the chart on the page 7, please place the packer on top of the vent disc, channel side down, as shown by the image to the right of this text box.

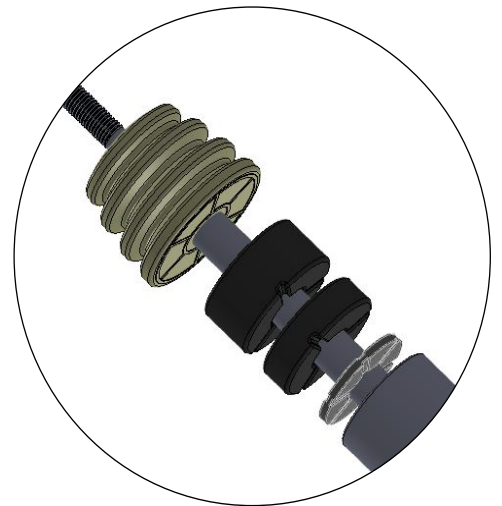

25. With the OEM spring still compressed, slide the new Belltech strut into the OEM spring and install Belltech bump stop on the strut rod.
26. Complete the assembly using the OEM spring isolator, top mount, and supplied Nyloc nut.
27. Align the top mount with the spring using the original marking made in step 18. Torque the strut rod nut to 26 ft lbs.

BELLTECH STRUT INSTALLATION

31. Install the new assembly in reverse order of disassembly. Use the OEM nuts and bolts if none were included. Torque to factory specs with the weight of the vehicle on the suspension.



Technician note:

To help with the installation of your new strut, view and reference the photographs from steps 9 through 17. Remember to torque all components with the weight of the vehicle on the suspension.

32. Place the strut assembly into the chassis and secure it using the three OE nuts. Torque to 46 ft lbs.
33. Clip the harness to the original position on strut mount stud.
34. Use a jack or other lifting component to raise the lower control arm back into place with the lower strut mount.
35. Using a 21mm and a 24mm wrench, attach the new Belltech strut with OE strut fork blot and nut. Torque to 124 ft lbs.



36. Attach upper control arm ball joint to the spindle. A jack may help support the weight of the spindle. Torque the upper ball joint nut to 26 ft lbs. + 180° turn.
37. Attach the front brake caliper with the original bolts, torque to 55 ft lbs.
38. Connect the ABS and brake lines, route the ABS line behind the brake backing plate and under the steering arm on the spindle.



39. Attach the outer tie rods into the spindle. Torque to 41 ft lbs. + 180° turn.
40. Attach the lower sway bar end link to the lower control arm with the original nut. Torque to 81 ft lbs.

FINALIZING THE INSTALLATION

41. Mount the wheels and tighten the lug nuts.
42. Lift the vehicle and remove the support stands.
43. Carefully lower the vehicle onto the flat ground.
44. Torque the lug nuts to 130 ft lbs.
45. Check that all components and fasteners have been properly installed and torqued.
46. Read and perform all tasks in the “Before Driving Your Vehicle” section of page 1 of your instructions.

THANK YOU FOR CHOOSING BELLTECH.

You are now a part of the Belltech family and we are eager to catch a glimpse of your newly modified vehicle. Give us a shout out and let us know how much you love our product. Don't forget, we offer other Belltech related merchandise for you and your vehicle on our website www.belltech.com

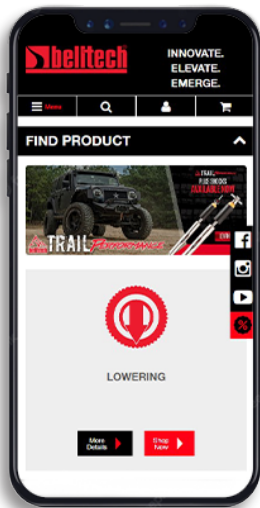

belltechsuspension



Belltech Suspension



@belltechsuspension

If you have any questions, concerns, or warranty related issues regarding your Belltech product, please call or email our experienced customer service specialists.

Belltech Customer Support:

Phone: 1-800-445-3767

Email: info@belltech.com

KIT CONTENTS



28020		
Part number	Description	Qty
28020-100	BELLTECH LIFTING STRUT	1
25003-008	8MM LIFT RING	2
25003-016	16MM LIFT RING	2
4935-001	15MM PACKER	3
NUT	M12 x 1.25MM FLANGED NYLOC NUT	1
4926-001	BUMP STOP	1
65210031	VENT DISC	1
26015-001	SPRING PERCH	1