



## Ventvisor® Deflector

**For proper installation and best possible fit, please read all instructions BEFORE you begin. For technical assistance or to obtain missing parts, please call Customer Relations at 1-800-241-7219.**

### Important Safety Information



- CAUTION - Before driving, ensure that the vent visor is properly secured to vehicle.
- Do not use automatic "brush-style" car washes.
- Do not use cleaning solvents of any kind.
- Periodically check all components for tightness.

### Contents - 2 Piece Set **NOTE:** Actual product may vary from illustration.

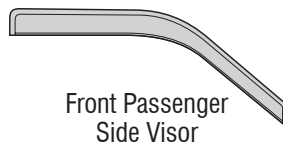
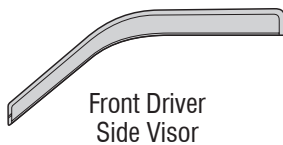

Alcohol Pad x2

### Contents - 4 Piece Set

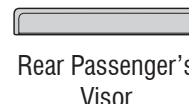
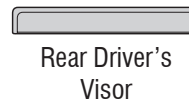
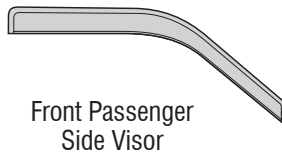
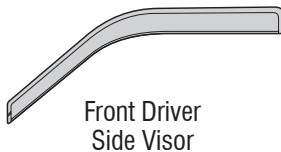

Alcohol Pad x4

### Tools Required



Car Wash Supplies



Clean Towel

### Preparation Before Painting / Installation

- A trial fit is recommended to ensure proper positioning and fit.
- Check fit of parts before painting as we will not accept the return of modified or painted parts.
- Wash and dry your vehicle to remove any debris and/or dirt from the installation area.

### Installation Steps **NOTE:** Actual application may vary slightly from illustrations.



Clean the chrome or black trim on the door frame with an alcohol pad, and wipe dry with a soft cloth.

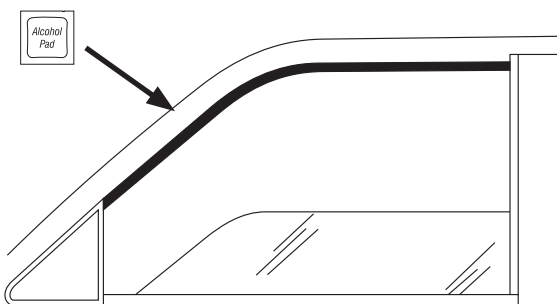

1

Remove tape liner from front and rear flanges of visor. Peel back 2" (5 cm) of tape liner from each end of the lateral flange.

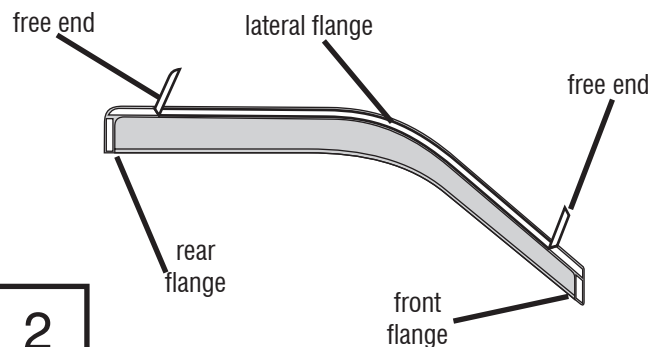

2

## Installation Steps

**NOTE:** Actual application may vary slightly from illustrations.

Align visor to the previously cleaned surface. The lateral flange attaches to the chrome or black trim. The front flange will attach on top of the mirror base plate.

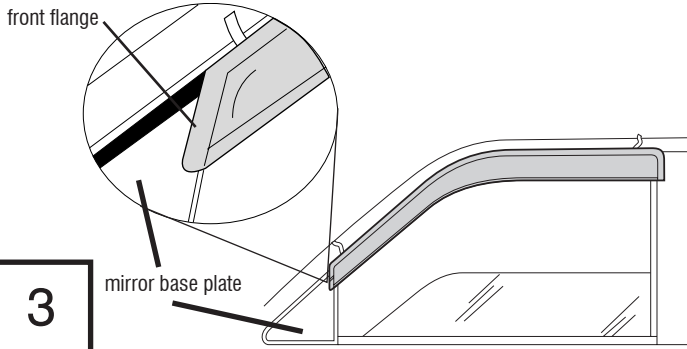

Gently press the exposed areas of tape against the surface and verify position. With the visor in its final position, remove the remaining tape liner by pulling on free ends.

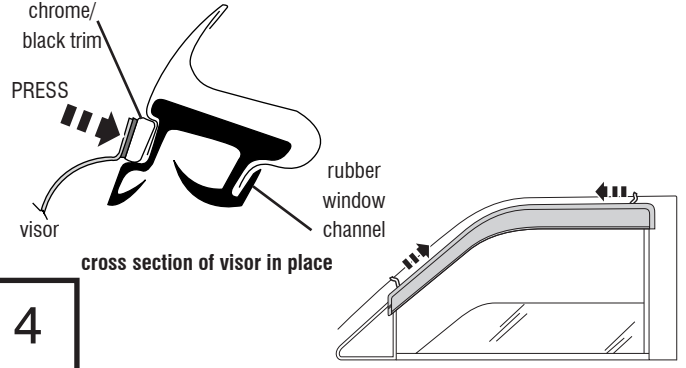

Apply pressure along all flanges to ensure proper adhesion of tape.

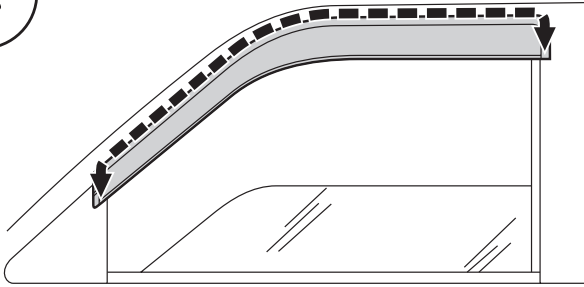

## 4 Piece Set

The rear visor attaches with the same preparation methods as the front visor.

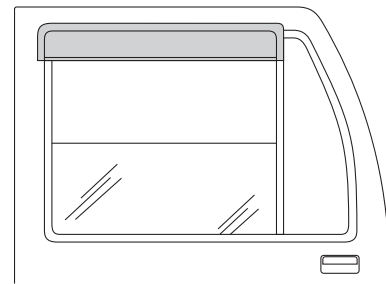

Repeat **Steps 1-6** for opposite side.

## Care and Cleaning

- Wash only with mild soap & dry with a clean cloth.

## Congratulations!

You have purchased one of the many quality Auto Ventshade™ branded products offered by Lund International, Inc. We take the utmost pride in our products and want you to enjoy years of satisfaction from your investment. We have made every effort to ensure that your product is top quality in terms of fit, durability, finish and ease of installation.



Lund International

800-241-7219 • Visit us at [lundinternational.com](http://lundinternational.com)

© 2012 Lund International, Inc. All rights reserved.

Auto Ventshade™, the Auto Ventshade™ logo and the AVS™ logo are trademarks of Lund International, Inc.





## Ventvisor® Deflector

Pour obtenir une installation correcte et le meilleur ajustement possible, lire toutes les instructions AVANT de commencer.  
 Pour toute assistance technique ou obtention de pièces manquantes, appeler le service des relations avec la clientèle au 1-800-241-7219.

### Informations importantes concernant la sécurité



- ATTENTION – Avant de conduire, s'assurer que la visière est solidement assujettie sur le véhicule.
- Ne pas utiliser les stations de lavage de voitures à brosses.
- Ne pas utiliser de solvants.
- Vérifier régulièrement le serrage des composants.

### Contenu - Ensemble 2 pièces

**NOTE:** Le produit réel peut changer de l'illustration.

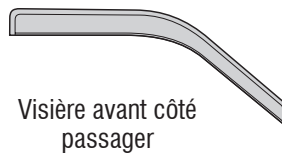

Tampons à l'alcool (2)

### Contenu - Ensemble 4 pièces

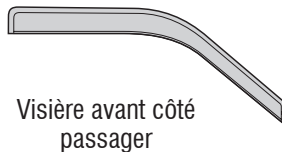

Visière arrière côté conducteur



Visière arrière côté passager



Tampons à l'alcool (4)

### Outils nécessaires



Fournitures pour lavage de voiture



Serviette propre

### Préparation pour la peinture/l'installation

- Il est recommandé de procéder à un essai pour s'assurer que le positionnement et l'ajustement sont corrects.
- Vérifier l'ajustement des pièces avant peinture, car nous n'acceptons pas le retour de pièces modifiées ou peintes.
- Laver les glissières de glaces de la portière du véhicule pour éliminer toute poussière et tous débris.
- Sécher les glissières avec une serviette propre.

### Étapes d'installation

**REMARQUE :** La méthode d'application peut être légèrement différente de celle représentée par les illustrations.



Nettoyer la garniture noire ou en chrome du cadre de la portière avec un tampon à l'alcool et la sécher avec un chiffon doux.

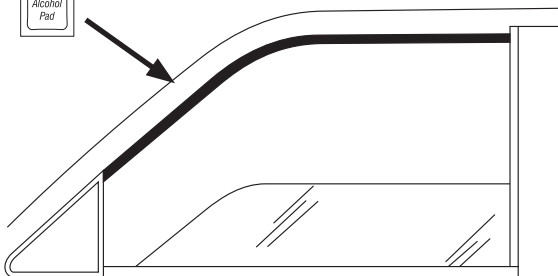

1

Retirer la protection d'adhésif des rebords avant et arrière de la visière. Décoller 5 cm (2 po) de protection d'adhésif à chaque extrémité du rebord latéral.

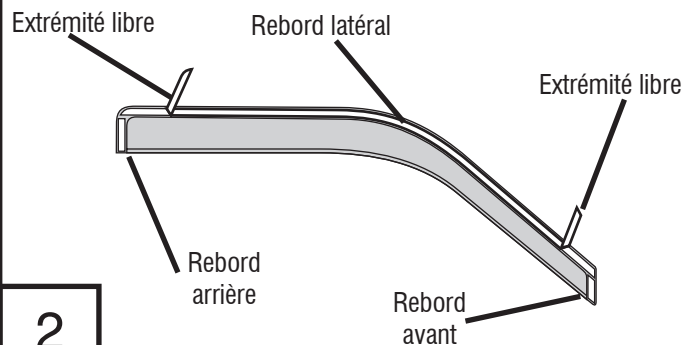

2

## Étapes d'installation

REMARQUE : La méthode d'application peut être légèrement différente de celle représentée par les illustrations.

Aligner la visière et la surface précédemment nettoyée. Le rebord latéral se fixe sur la garniture en chrome ou noire. Le rebord avant se fixe en haut du socle du rétroviseur.

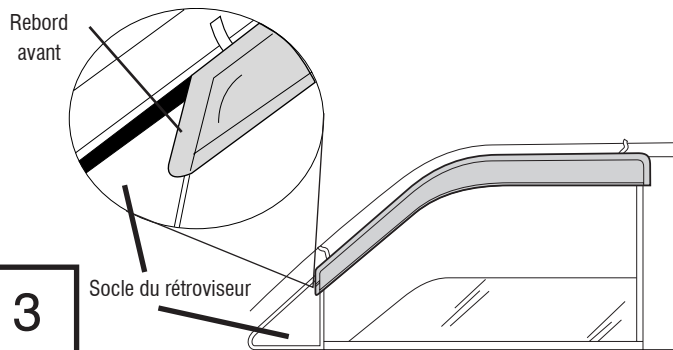

3

Pousser doucement les parties exposées du ruban adhésif contre la surface et vérifier la position. Une fois la visière en position finale, retirer le reste de la protection d'adhésif en tirant sur les extrémités libres.

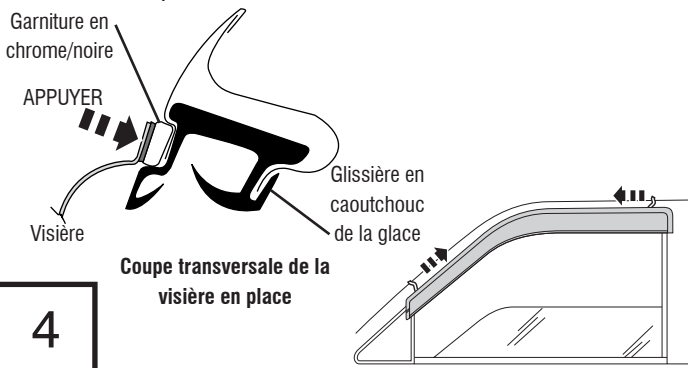

4

Appuyer le long de tous les rebords pour assurer la bonne adhésion de la bande adhésive.

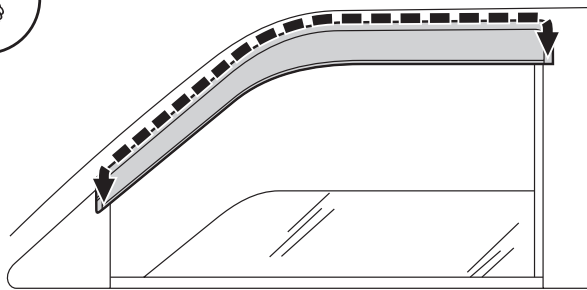

5

## Ensemble 4 pièces

L'installation de la visière arrière demande la même préparation que la visière avant.

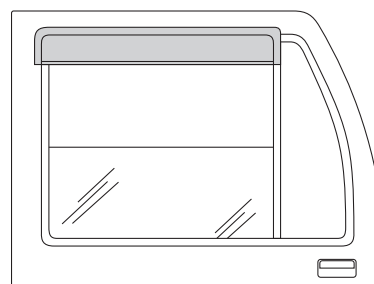

6

Répéter les étapes 1 à 6 pour le côté opposé.

## Entretien et nettoyage

- Laver exclusivement avec de l'eau savonneuse et sécher avec un chiffon propre.

## Félicitations !

Vous avez acheté l'un des nombreux produits de qualité Auto Ventshade™ fabriqués par Lund International, Inc. Nous sommes extrêmement fiers de nos produits et souhaitons que vous tiriez des années de satisfaction de votre investissement. Nous avons pris toutes les mesures nécessaires pour assurer que ce produit est d'une qualité supérieure en ce qui concerne l'ajustement, la durabilité, la finition et la facilité d'installation.



Lund International

800-241-7219 • Visitez notre site [lundinternational.com](http://lundinternational.com)

© 2012 Lund International, Inc. Tous droits réservés.



Auto Ventshade™, le logo Auto Ventshade™ et le logo AVS™ sont des marques déposées de Lund International, Inc.





## Ventvisor® Deflector

**Para una instalación adecuada y el mejor ajuste posible, lea todas las instrucciones ANTES de comenzar. Si desea recibir asistencia técnica u obtener piezas faltantes, llame al Servicio al cliente al 1-800-241-7219.**

### Información importante de seguridad



- **PRECAUCIÓN** - Antes de conducir, asegúrese de que la visera esté correctamente anclada al vehículo.
- No utilice servicios automáticos de limpieza de vehículos que utilizan cepillos.
- No utilice limpiadores al solvente de ningún tipo.
- Compruebe periódicamente que todos los componentes estén ajustados.

### Contenido - Juego de dos piezas

**NOTA:** El producto real puede variar de la ilustración.

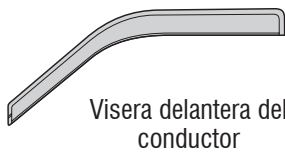

Visera delantera del conductor



Visera delantera del acompañante



Paños esterilizados x 2

### Contenido - Juego de cuatro piezas

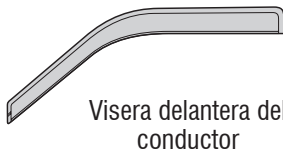

Visera delantera del conductor



Visera delantera del acompañante



Visera trasera del conductor



Visera trasera del acompañante



Paños esterilizados x 4

### Herramientas necesarias



Equipo de limpieza de vehículos



Toalla limpia

### Preparación antes de pintar o instalar

- Se recomienda realizar un ajuste de prueba para asegurar el posicionamiento y ajuste correctos.
- Compruebe que las piezas se ajusten correctamente antes de pintarlas, ya que no aceptaremos la devolución de piezas modificadas o pintadas.
- Lave los canales de la ventanilla del vehículo para quitar los desechos y la suciedad.
- Seque los canales de la ventanilla con una toalla limpia.

### Pasos de instalación

**AVISO:** La colocación real puede variar con respecto a las ilustraciones.

Alcohol Pad

Limpie la banda negra o cromada del marco de la puerta con un paño esterilizado y séquelo con un paño suave.

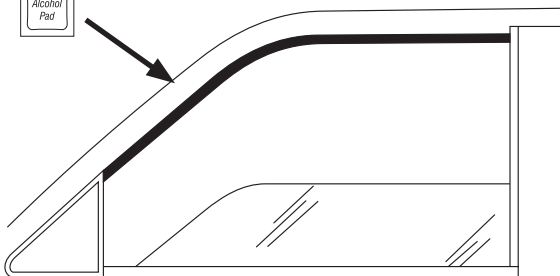

1

Quite la cinta protectora de los rebordes frontales y traseros de la visera. Retire 2" (5 cm) de cinta protectora de cada uno de los extremos del reborde lateral.

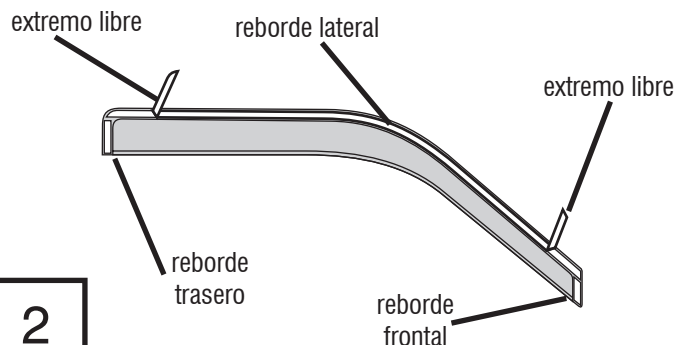

2

## Pasos de instalación

**AVISO:** La colocación real puede variar con respecto a las ilustraciones.

Alinee la visera con la superficie que limpió anteriormente. El reborde lateral se une a la banda negra o cromada. El reborde frontal se colocará en la parte superior de la placa de la base del espejo.

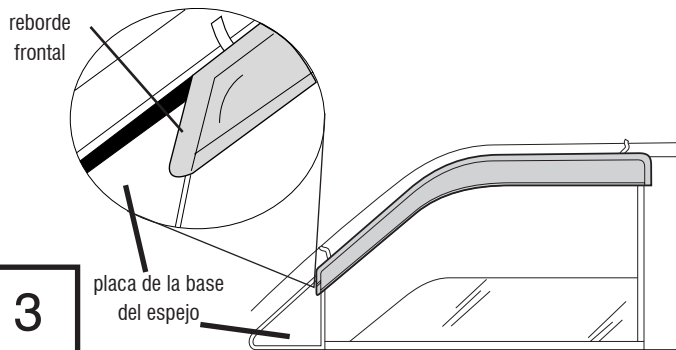

Presione suavemente las áreas expuestas de la cinta contra la superficie y verifique la posición. Una vez que la visera se encuentre en su posición definitiva, quite la cinta protectora restante tirando de los extremos libres.

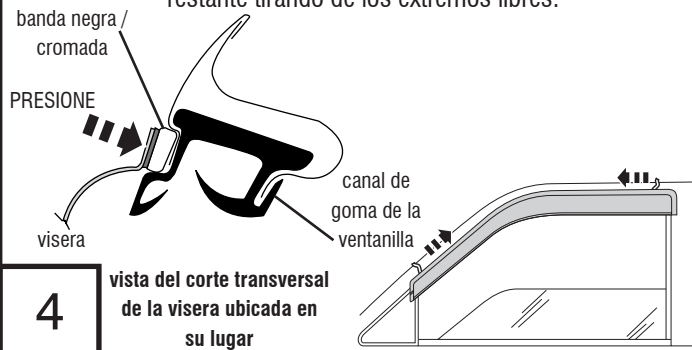

Presione todos los rebordes para asegurarse de que la cinta se adhiera correctamente.

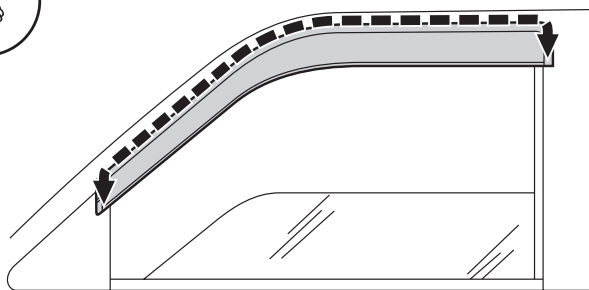

## Juego de cuatro piezas

La visera trasera se coloca siguiendo el mismo procedimiento que se sigue para colocar la visera delantera.

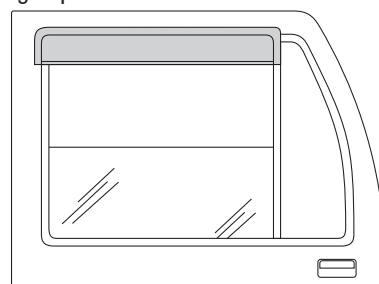

Repita los pasos 1 al 6 para el otro lado del vehículo.

## Cuidado y limpieza

- Limpie solamente con agua jabonosa tibia y seque con un paño limpio.

## Felicidades

Usted ha comprado uno de los tantos artículos de calidad de Auto Ventshade™ ofrecidos por Lund International, Inc. Nuestros productos son nuestro mayor orgullo. Deseamos que disfrute de años de satisfacción con su inversión. Hemos realizado todos los esfuerzos para asegurarnos de que su producto sea de la mejor calidad en cuanto a ajuste, durabilidad, acabado y facilidad de instalación.



Lund International

800-241-7219 • Visite nuestro sitio Web: [lundinternational.com](http://lundinternational.com)

© 2012 Lund International, Inc. Todos los derechos reservados.



Auto Ventshade™, el logo de Auto Ventshade™ y el logo de AVS™ son marcas comerciales de Lund International, Inc.

