

# Installation Instructions

I - Sheet Number VV91 Rev.A



## Ventvisor® Deflector

For proper installation and best possible fit, please read all instructions **BEFORE** you begin.  
For technical assistance or to obtain missing parts, please call Customer Relations at 1-800-241-7219.

### Important Safety Information



- CAUTION - Before driving, ensure that the vent visor is properly secured to vehicle.
- Do not use automatic "brush-style" car washes.
- Do not use cleaning solvents of any kind.
- Periodically check all components for tightness.

### Contents - 2 Piece Set **NOTE:** Actual product may vary from illustration.

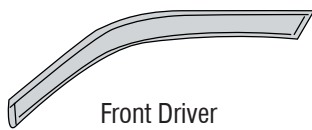

Front Driver Side Visor



Front Passenger Side Visor



Alcohol Pad x2

### Contents - 4 Piece Set



Front Driver Side Visor

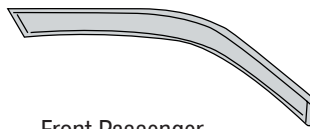

Front Passenger Side Visor

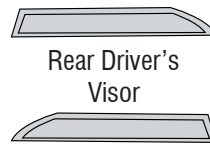

Rear Driver's Visor



Rear Passenger's Visor



Alcohol Pad x4

### Tools Required



Car Wash Supplies



Clean Towel

### Preparation Before Painting / Installation

- A trial fit is recommended to ensure proper positioning and fit.
- Check fit of parts before painting as we will not accept the return of modified or painted parts.
- Wash and dry your vehicle to remove any debris and/or dirt from the installation area.

### Installation Steps **NOTE:** Actual application may vary slightly from illustrations.



Clean the black metal frame or chrome trim that runs along the top of the window with an alcohol pad, and wipe dry with a soft cloth.

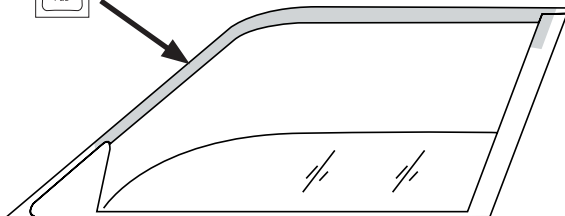

1

Remove tape liner from rear flange of visor. Peel back 2" (5 cm) of tape liner from each end of the lateral flange.

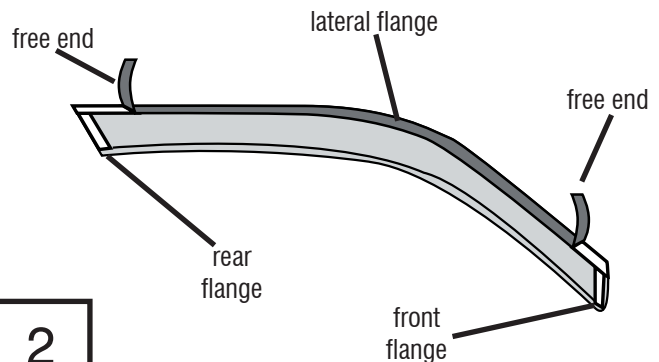

2

## Installation Steps

**NOTE:** Actual application may vary slightly from illustrations.

Align visor to the previously cleaned surface. To facilitate positioning, line up the rear end flange and the radius of the visor first. The front end flange may overlap the mirror cap by 1/8" depending on the style of mirror you have.

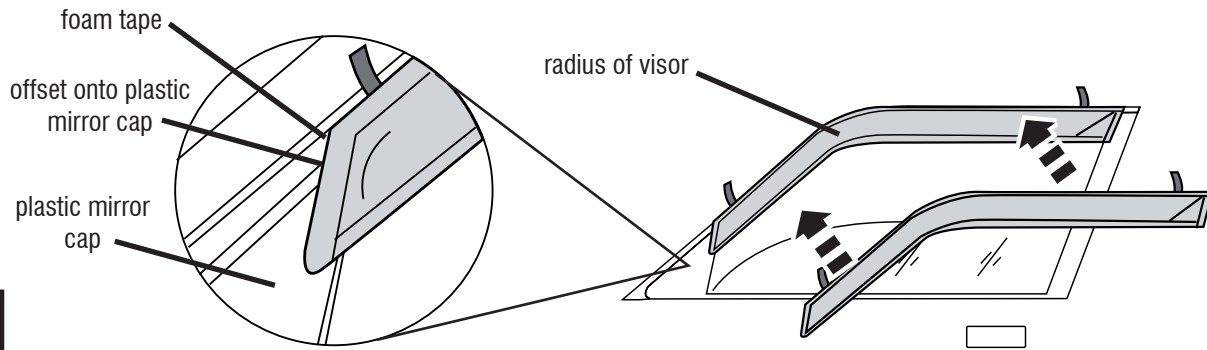

3

Gently press the exposed areas of tape against the surface and verify position.

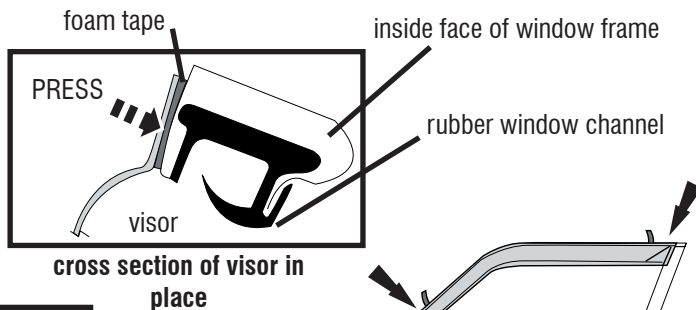

4

With the visor in its final position, remove the remaining tape liner by pulling on free ends.

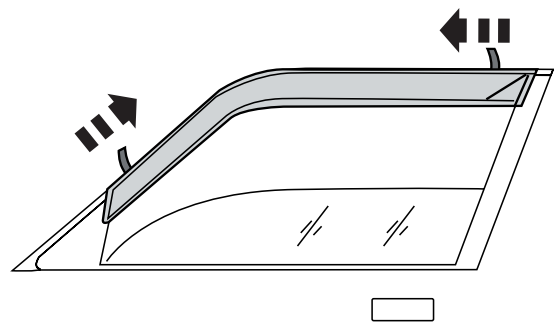

5

Apply pressure along all flanges to ensure proper adhesion of tape.

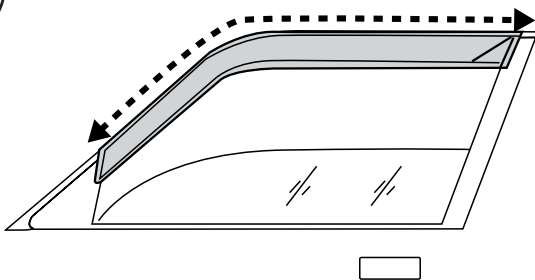

6

## 4 Piece Set

The rear visor attaches with the same preparation methods as the front visor.

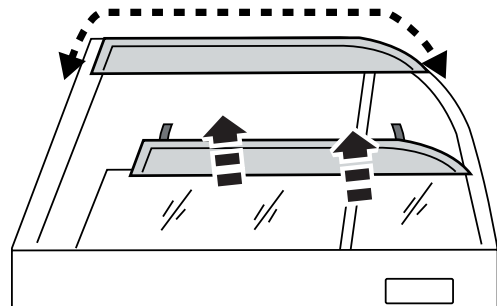

7

Repeat **Steps 1-7** for opposite side.

## Care and Cleaning

- Wash only with mild soap & dry with a clean cloth.

## Congratulations!

You have purchased one of the many quality Auto Ventshade™ branded products offered by Lund International, Inc. We take the utmost pride in our products and want you to enjoy years of satisfaction from your investment. We have made every effort to ensure that your product is top quality in terms of fit, durability, finish and ease of installation.



Lund International, Ventshade Accessories Division  
655 Raco Drive, Lawrenceville, GA 30045

800-241-7219 • Fax 770-339-5839 • Visit us at [lundinternational.com](http://lundinternational.com)

© 2005 Lund International, Inc. All rights reserved.

Auto Ventshade™, the Auto Ventshade™ logo and the AVS™ logo are trademarks of Lund International, Inc.





## Ventvisor® Deflector

Pour obtenir une installation correcte et le meilleur ajustement possible, lire toutes les instructions AVANT de commencer.  
 Pour toute assistance technique ou obtention de pièces manquantes, appeler le service des relations avec la clientèle au 1-800-241-7219.

### Informations importantes concernant la sécurité



- ATTENTION – Avant de conduire, s'assurer que la visière est solidement assujettie sur le véhicule.
- Ne pas utiliser les stations de lavage de voitures à brosses.
- Ne pas utiliser de solvants.
- Vérifier régulièrement le serrage des composants.

### Contenu - Ensemble 2 pièces

**NOTE:** Le produit réel peut changer de l'illustration.

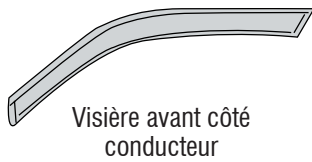

Visière avant côté conducteur

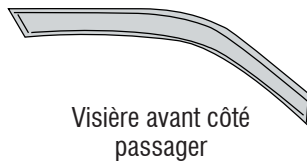

Visière avant côté passager



Tampons à l'alcool (2)

### Contenu - Ensemble 4 pièces

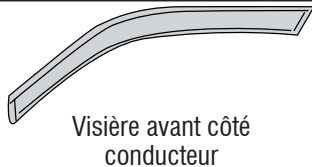

Visière avant côté conducteur

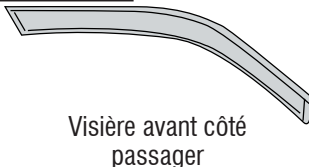

Visière avant côté passager



Visière arrière côté conducteur



Visière arrière côté passager



Tampons à l'alcool (4)

### Outils nécessaires



Fournitures pour lavage de voiture



Serviette propre

### Préparation pour la peinture/l'installation

- Il est recommandé de procéder à un essai pour s'assurer que le positionnement et l'ajustement sont corrects.
- Vérifier l'ajustement des pièces avant peinture, car nous n'acceptons pas le retour de pièces modifiées ou peintes.
- Laver les glissières de glaces de la portière du véhicule pour éliminer toute poussière et tous débris.
- Sécher les glissières avec une serviette propre.

### Étapes d'installation

**REMARQUE :** La méthode d'application peut être légèrement différente de celle représentée par les illustrations.



Avec un tampon à l'alcool, nettoyer le cadre métallique noir ou la garniture en chrome, le long de la partie supérieure de la glace, puis sécher la surface avec un chiffon doux.

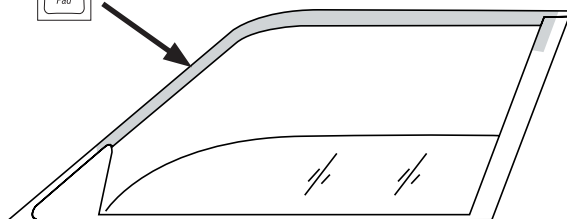

1

Retirer la protection d'adhésif du rebord arrière de la visière. Décoller 5 cm (2 po) de protection d'adhésif à chaque extrémité du rebord latéral.

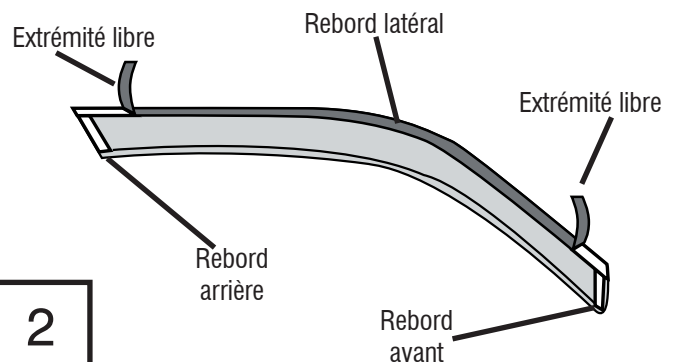

2

## Étapes d'installation

REMARQUE : La méthode d'application peut être légèrement différente de celle représentée par les illustrations.

Aligner la visière et la surface précédemment nettoyée. Pour faciliter le positionnement, aligner d'abord le rebord d'extrémité arrière et le rayon de la visière. Le rebord d'extrémité avant peut chevaucher le couvercle du rétroviseur de 3 mm, suivant le style du rétroviseur.

Isolant adhésif  
Partie décalée  
du couvercle  
en plastique du  
rétroviseur  
Couvercle en  
plastique du  
rétroviseur

Rayon de la  
visière

3

Pousser doucement les parties exposées du ruban adhésif contre la surface et vérifier la position.

Une fois la visière en position finale, retirer le reste de la protection d'adhésif en tirant sur les extrémités libres.

Isolant adhésif

Face intérieure du cadre  
de glace

Glissière en caoutchouc de  
la glace

APPUYER

Visière

Coupe transversale de la  
visière en place

4

5

Appuyer le long de tous les rebords pour assurer la bonne adhésion de la bande adhésive.

## Ensemble 4 pièces

L'installation de la visière arrière demande la même préparation que la visière avant.

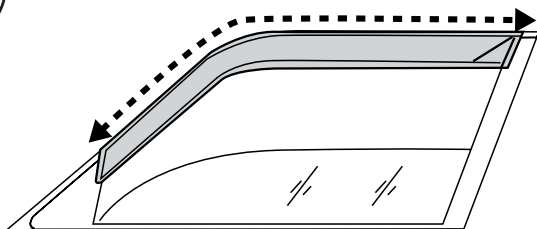

6

7

Répéter les étapes 1 à 7 pour le côté opposé.

## Entretien et nettoyage

- Laver exclusivement avec de l'eau savonneuse et sécher avec un chiffon propre.

## Félicitations !

Vous avez acheté l'un des nombreux produits de qualité Auto Ventshade™ fabriqués par Lund International, Inc. Nous sommes extrêmement fiers de nos produits et souhaitons que vous tiriez des années de satisfaction de votre investissement. Nous avons pris toutes les mesures nécessaires pour assurer que ce produit est d'une qualité supérieure en ce qui concerne l'ajustement, la durabilité, la finition et la facilité d'installation.



AUTO VENTSHADE™

Lund International, Ventshade Accessories Division  
655 Raco Drive, Lawrenceville, GA 30045, USA

800-241-7219 • Fax 770-339-5839 • Visitez notre site [lundinternational.com](http://lundinternational.com)

© 2005 Lund International, Inc. Tous droits réservés.

Auto Ventshade™, le logo Auto Ventshade™ et le logo AVS™ sont des marques déposées de Lund International, Inc.





## Ventvisor® Deflector

**Para una instalación adecuada y el mejor ajuste posible, lea todas las instrucciones ANTES de comenzar. Si desea recibir asistencia técnica u obtener piezas faltantes, llame al Servicio al cliente al 1-800-241-7219.**

### Información importante de seguridad



- **PRECAUCIÓN** - Antes de conducir, asegúrese de que la visera esté correctamente anclada al vehículo.
- No utilice servicios automáticos de limpieza de vehículos que utilizan cepillos.
- No utilice limpiadores al solvente de ningún tipo.
- Compruebe periódicamente que todos los componentes estén ajustados.

### Contenido - Juego de dos piezas

**NOTA:** El producto real puede variar de la ilustración.



Visera delantera del conductor



Visera delantera del acompañante



Paños esterilizados x 2

### Contenido - Juego de cuatro piezas



Visera delantera del conductor



Visera delantera del acompañante



Visera trasera del conductor



Visera trasera del acompañante



Paños esterilizados x 4

### Herramientas necesarias



Equipo de limpieza de vehículos



Toalla limpia

### Preparación antes de pintar o instalar

- Se recomienda realizar un ajuste de prueba para asegurar el posicionamiento y ajuste correctos.
- Compruebe que las piezas se ajusten correctamente antes de pintarlas, ya que no aceptaremos la devolución de piezas modificadas o pintadas.
- Lave los canales de la ventanilla del vehículo para quitar los desechos y la suciedad.
- Seque los canales de la ventanilla con una toalla limpia.

### Pasos de instalación

**AVISO:** La colocación real puede variar con respecto a las ilustraciones.



Limpie el marco metálico negro o la banda cromada que se extiende a lo largo de la parte superior de la ventanilla con un paño esterilizado y séquelo con un paño suave.

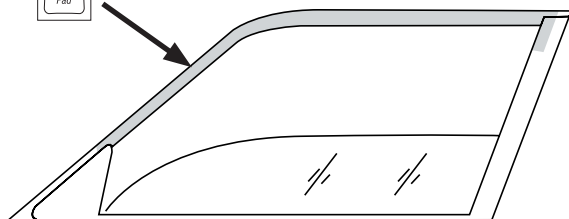

1

Quite la cinta protectora del reborde trasero de la visera. Retire 2" (5 cm) de cinta protectora de cada uno de los extremos del reborde lateral.

extremo libre

reborde lateral

extremo libre

reborde trasero

reborde frontal

2

## Pasos de instalación

**AVISO:** La colocación real puede variar con respecto a las ilustraciones.

Alinee la visera con la superficie que limpió anteriormente. Para facilitar la colocación, primero alinee el extremo del reborde trasero con el radio de la visera. El extremo del reborde frontal puede superponerse con la cubierta del espejo por 1/8" dependiendo del estilo de espejo que tenga.

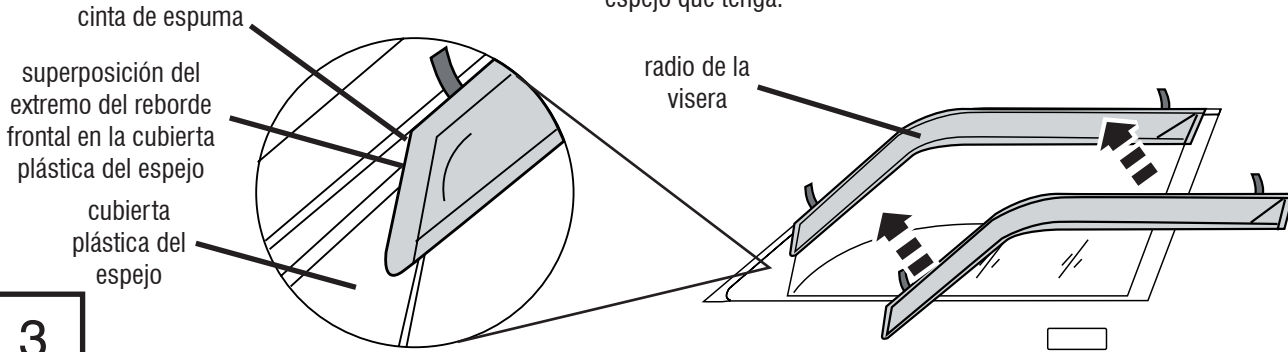

Presione suavemente las áreas expuestas de la cinta contra la superficie y verifique la posición.

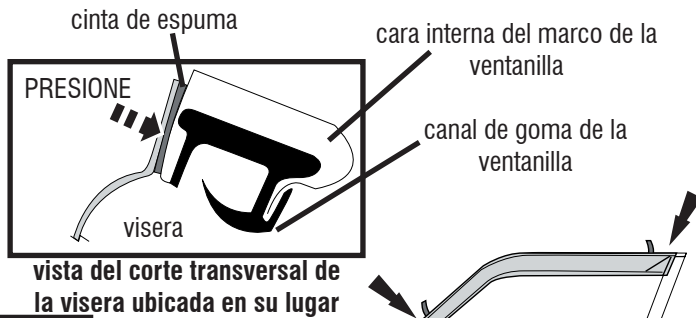

Una vez que la visera se encuentre en su posición definitiva, quite la cinta protectora restante tirando de los extremos libres.

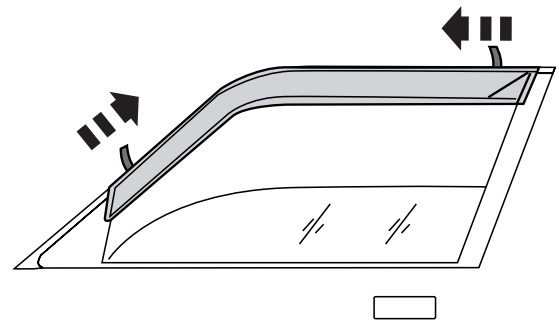

Presione todos los rebordes para asegurarse de que la cinta se adhiera correctamente.

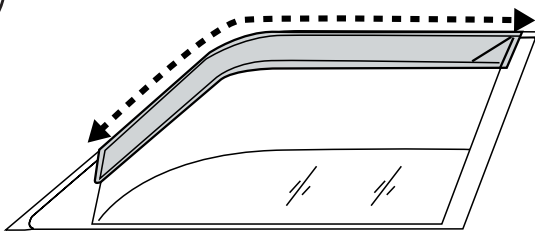

## Juego de cuatro piezas

La visera trasera se coloca siguiendo los mismos pasos que se siguen para la visera delantera.

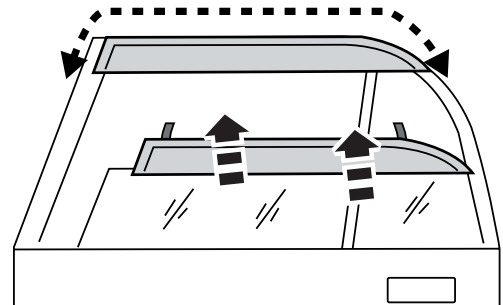

Repita los pasos 1 al 7 para el otro lado del vehículo.

## Cuidado y limpieza

- Limpie solamente con agua jabonosa tibia y seque con un paño limpio.

## Felicidades

Usted ha comprado uno de los tantos artículos de calidad de Auto Ventshade™ ofrecidos por Lund International, Inc. Nuestros productos son nuestro mayor orgullo. Deseamos que disfrute de años de satisfacción con su inversión. Hemos realizado todos los esfuerzos para asegurarnos de que su producto sea de la mejor calidad en cuanto a ajuste, durabilidad, acabado y facilidad de instalación.



AUTO VENTSHADE™

Lund International, Ventshade Accessories Division

655 Raco Drive, Lawrenceville, GA 30045

800-241-7219 • Fax 770-339-5839 • Visite nuestro sitio Web: [lundinternational.com](http://lundinternational.com)

© 2005 Lund International, Inc. Todos los derechos reservados.



Auto Ventshade™, el logo de Auto Ventshade™ y el logo de AVS™ son marcas comerciales de Lund International, Inc.

