



Bugflector® - Bugflector II® - Carflector®

For proper installation and best possible fit, please read all instructions **BEFORE** you begin.
For technical assistance or to obtain missing parts, please call Customer Relations at 1-800-241-7219.

Important Safety Information



- CAUTION - Before driving, ensure that the hood shield is properly secured to vehicle.
- Do not use automatic "brush-style" car washes.
- Do not use cleaning solvents of any kind.
- Periodically check all components for tightness.

Contents **NOTE:** Actual product may vary from illustration.



Hood shield

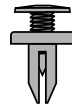

Fasteners
(98059)
x 4



Fasteners
(98042)
x 2



Bump ons
x 4

Tools Required



Car Wash Supplies



Clean Towel

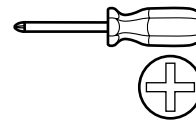

Phillips
screwdriver

Preparation Before Painting / Installation

- A trial fit is recommended to ensure proper positioning and fit.
- Check fit of parts before painting as we will not accept the return of modified or painted parts.
- Wash and dry your vehicle to remove any debris and/or dirt from the installation area.

Installation Steps **NOTE:** Actual application may vary slightly from illustrations.

Raise hood.

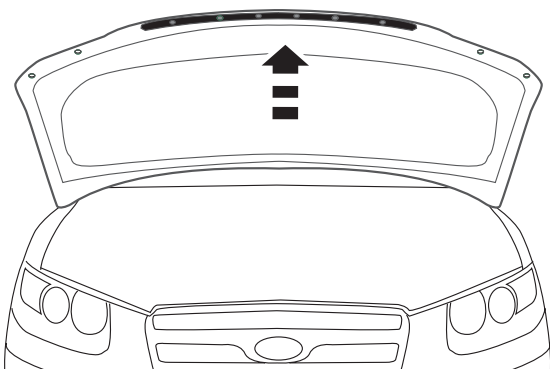

1

Locate (4) circular holes on the underside of hood. Clean the area around these with a soft cloth.

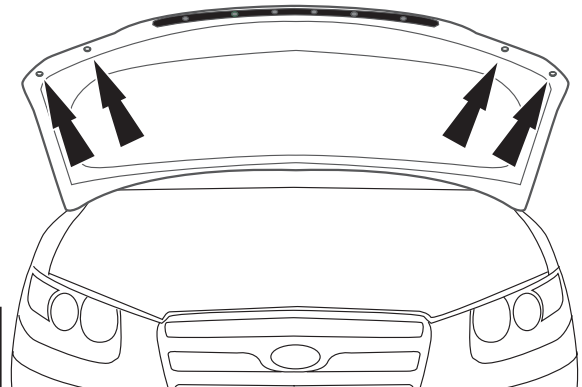

2

Installation Steps **NOTE:** Actual application may vary slightly from illustrations.

Locate (2) fasteners installed in the middle of the rubber trim on the front edge of the underside of the hood.

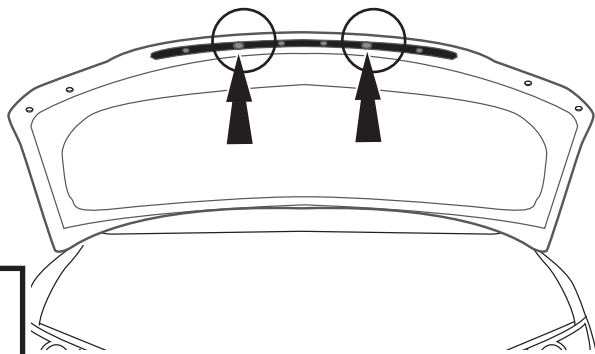

3

Remove (2) middle fasteners from the rubber trim piece on the front edge underside of hood.

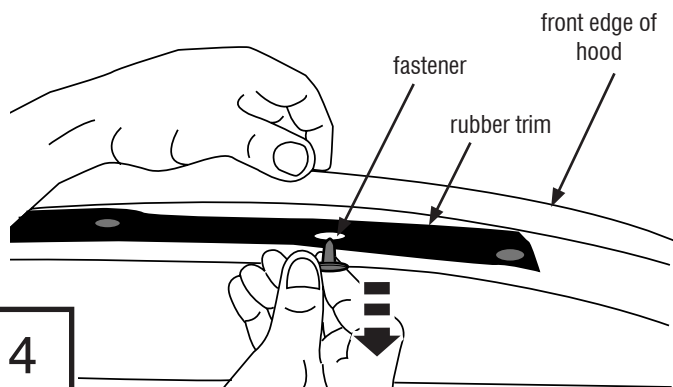

4

Align hood shield with holes in hood. Hood shield slides **UNDER** the rubber trim piece.

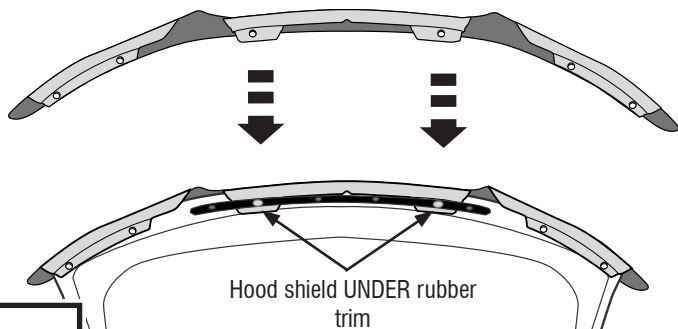

5

Insert (2) fasteners through holes in rubber trim, then through hood shield, and into hood. Tighten fasteners. **DO NOT OVERTIGHTEN.**

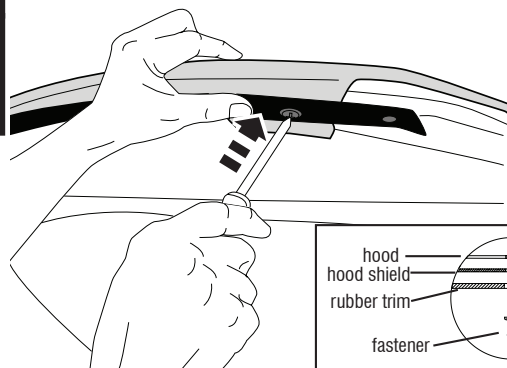
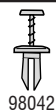

6



98059

Install (4) remaining fasteners. **DO NOT OVERTIGHTEN.**

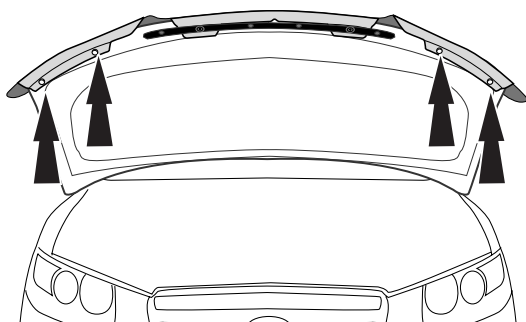
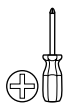

7



Close hood. Install (4) bump ons on pre-cleaned areas of hood surface.

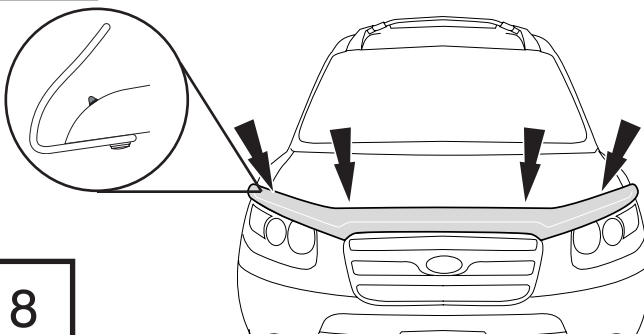

8

Care and Cleaning

- Wash only with mild soap & dry with a clean cloth.

Congratulations!

You have purchased one of the many quality Auto Ventshade™ branded products offered by Lund International, Inc. We take the utmost pride in our products and want you to enjoy years of satisfaction from your investment. We have made every effort to ensure that your product is top quality in terms of fit, durability, finish and ease of installation.



Lund International

800-241-7219 • Visit us at lundinternational.com

© 2012 Lund International, Inc. All rights reserved.

Auto Ventshade™, the Auto Ventshade™ logo and the AVS™ logo are trademarks of Lund International, Inc.





Bugflector® - Bugflector II® - Carflector®

Pour obtenir une installation correcte et le meilleur ajustement possible, lire toutes les instructions AVANT de commencer. Pour toute assistance technique ou obtention de pièces manquantes, appeler le service des relations avec la clientèle au 1-800-241-7219.

Informations importantes concernant la sécurité



- ATTENTION – Avant de conduire, s'assurer que le pare-insectes est solidement assujettie sur le véhicule.
- Ne pas utiliser les stations de lavage de voitures à brosses.
- Ne pas utiliser de solvants.
- Vérifier régulièrement le serrage des composants.

Contenu

NOTE: Le produit réel peut changer de l'illustration.



Pare-insectes

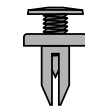

Fixation
(98059)
(4)



Fixation
(98042)
(2)



Butoirs (4)

Outils nécessaires



Fournitures pour lavage
de voiture



Serviette propre

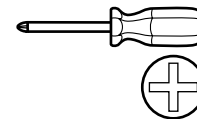

Tournevis
Phillips

Préparation pour la peinture/l'installation

- Il est recommandé de procéder à un essai pour s'assurer que le positionnement et l'ajustement sont corrects.
- Vérifier l'ajustement des pièces avant peinture, car nous n'acceptons pas le retour de pièces modifiées ou peintes.
- Laver les glissières de glaces de la portière du véhicule pour éliminer toute poussière et tous débris.
- Sécher les glissières avec une serviette propre.

Étapes d'installation

REMARQUE : La méthode d'application peut être légèrement différente de celle représentée par les illustrations.

Ouvrir le capot.

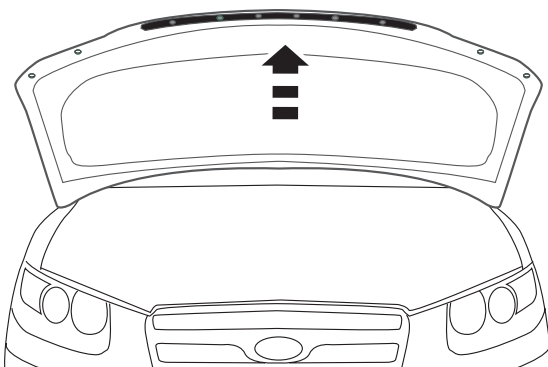

1

Localiser les 4 trous circulaires du dessous du capot. Nettoyer le pourtour des trous avec un chiffon doux.

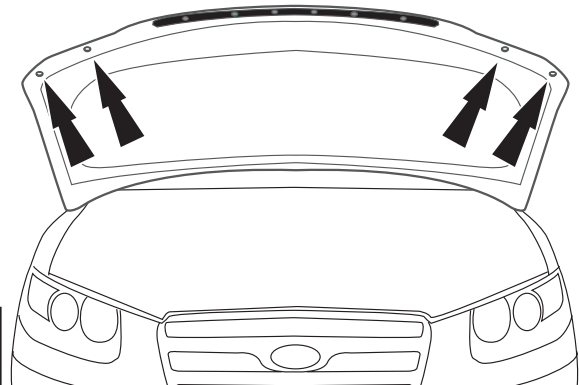

2

Étapes d'installation

REMARQUE : La méthode d'application peut être légèrement différente de celle représentée par les illustrations.

Localiser les 2 fixations installées au milieu de la garniture en caoutchouc, sur le rebord avant du dessous du capot.

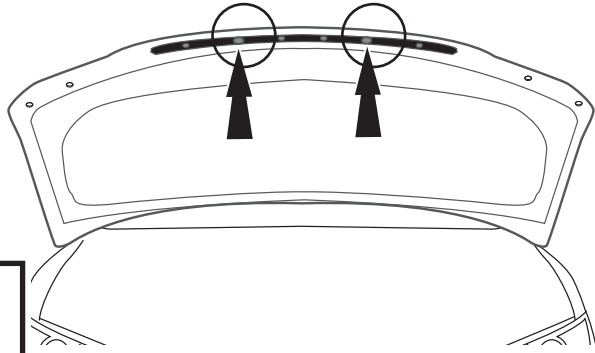

3

Retirer les 2 fixations du milieu de la garniture en caoutchouc, sur le rebord avant du dessous du capot.

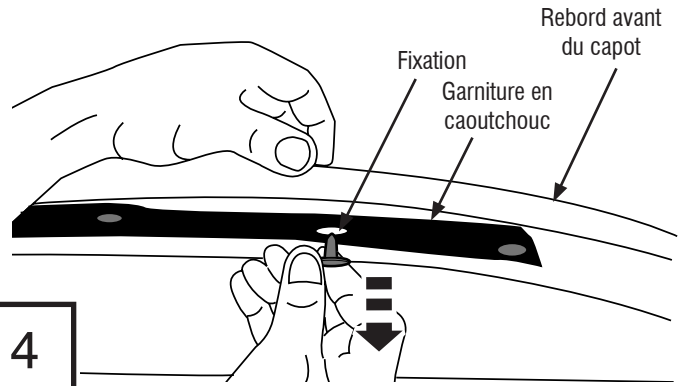

4

Aligner le pare-insectes et les trous du capot. Le pare-insectes se glisse **SOUS** la garniture en caoutchouc.

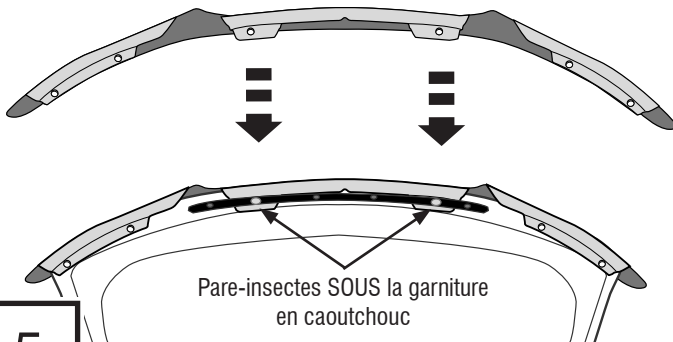

5

Insérer 2 fixations dans les trous de la garniture en caoutchouc, dans le pare-insectes puis dans le capot. Resserrer les fixations. **NE PAS TROP SERRER.**

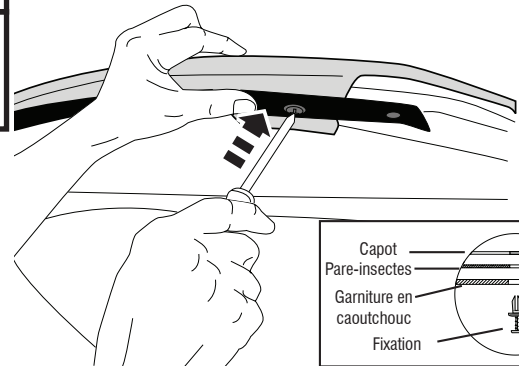

6

Installer les 4 fixations restantes. **NE PAS TROP SERRER.**

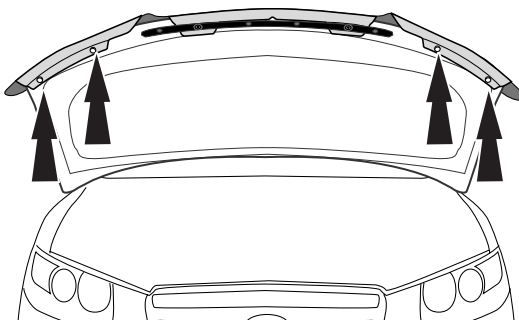
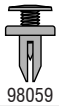

7

Fermer le capot. Installer quatre 4 butoirs sur les surfaces prénettoyées du capot.

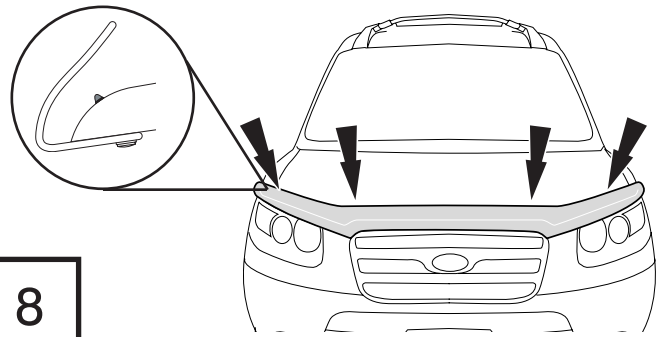

8

Entretien et nettoyage

- Laver exclusivement avec de l'eau savonneuse et sécher avec un chiffon propre.

Félicitations !

Vous avez acheté l'un des nombreux produits de qualité Auto Ventshade™ fabriqués par Lund International, Inc. Nous sommes extrêmement fiers de nos produits et souhaitons que vous tiriez des années de satisfaction de votre investissement. Nous avons pris toutes les mesures nécessaires pour assurer que ce produit est d'une qualité supérieure en ce qui concerne l'ajustement, la durabilité, la finition et la facilité d'installation.



Lund International

800-241-7219 • Visitez notre site lundinternational.com

© 2012 Lund International, Inc. Tous droits réservés.



Auto Ventshade™, le logo Auto Ventshade™ et le logo AVS™ sont des marques déposées de Lund International, Inc.





Bugflector® - Bugflector II® - Carflector®

Para una instalación adecuada y el mejor ajuste posible, lea todas las instrucciones ANTES de comenzar. Si desea recibir asistencia técnica u obtener piezas faltantes, llame al Servicio al cliente al 1-800-241-7219.

Información importante de seguridad



- PRECAUCIÓN - Antes de conducir, asegúrese de que la visera deflectora esté correctamente anclada al vehículo.
- No utilice servicios automáticos de limpieza de vehículos que utilizan cepillos.
- No utilice limpiadores al solvente de ningún tipo.
- Compruebe periódicamente que todos los componentes estén ajustados.

Contenido

NOTA: El producto real puede variar de la ilustración.



Cubierta para capó

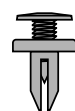

Sujetador
(98059)
(4)



Sujetador
(98042)
(2)



Soporte (4)

Herramientas necesarias



Equipo de limpieza de
vehículos

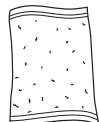

Toalla limpia

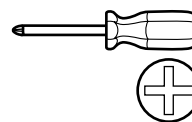

Destornillador
Phillips

Preparación antes de pintar o instalar

- Se recomienda realizar un ajuste de prueba para asegurar el posicionamiento y ajuste correctos.
- Compruebe que las piezas se ajusten correctamente antes de pintarlas, ya que no aceptaremos la devolución de piezas modificadas o pintadas.
- Lave los canales de la ventanilla del vehículo para quitar los desechos y la suciedad.
- Seque los canales de la ventanilla con una toalla limpia.

Pasos de instalación

NOTA: El uso real puede variar levemente de ilustraciones.

Levante el capó.

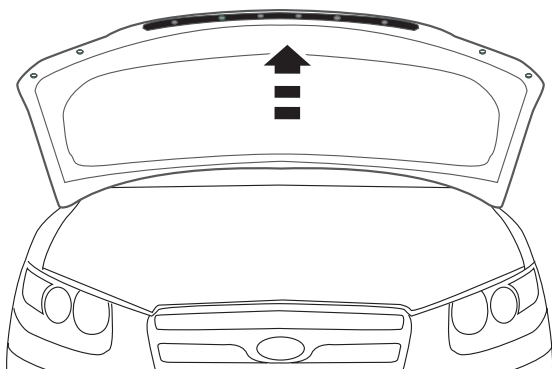

1

Ubique los (4) orificios circulares en la parte inferior del capó. Limpie el área alrededor de los orificios con un paño suave.

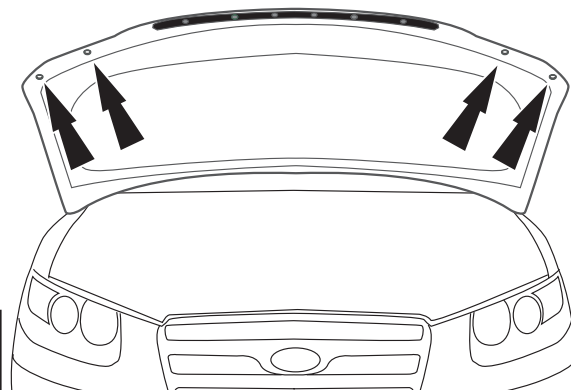

2

Pasos de instalación

NOTA: El uso real puede variar levemente de ilustraciones.

Ubique los (2) sujetadores instalados en el medio de la banda de goma en el borde delantero de la parte inferior del capó.

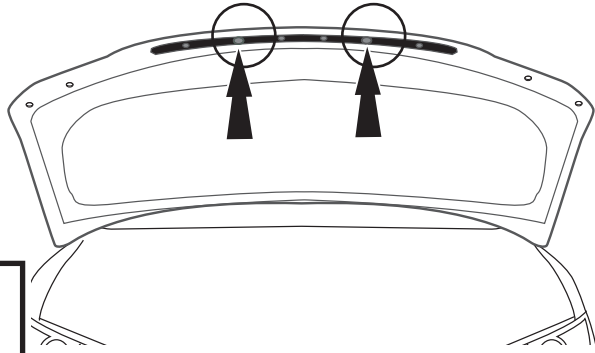

3

Quite los (2) sujetadores centrales de la banda de goma ubicada en el borde delantero de la parte inferior del capó.

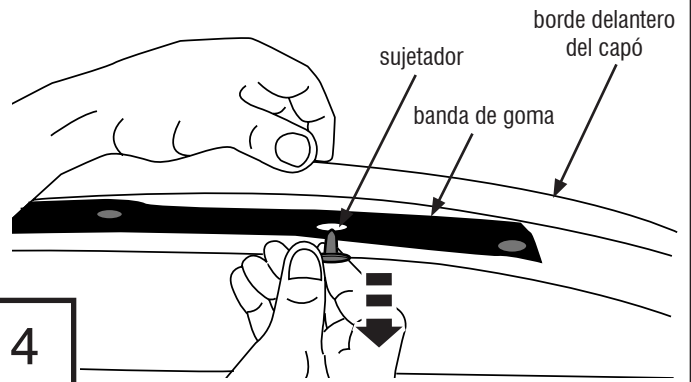

4

Alinee la cubierta para capó con los orificios del capó. La cubierta para capó se desliza por **DEBAJO** de la banda de goma.

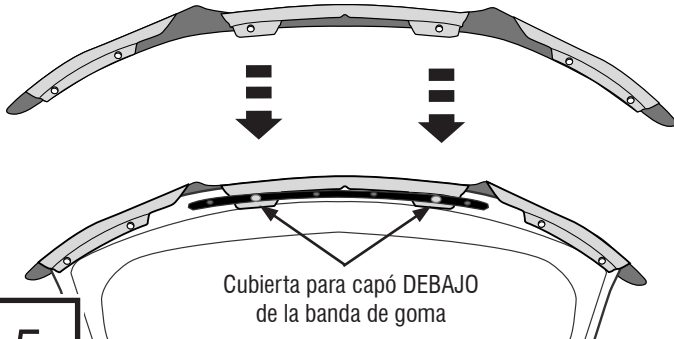

5

Introduzca (2) sujetadores en los orificios de la banda de goma, a través de la cubierta para capó y en el capó. Ajuste los sujetadores.

NO AJUSTE DEMASIADO.

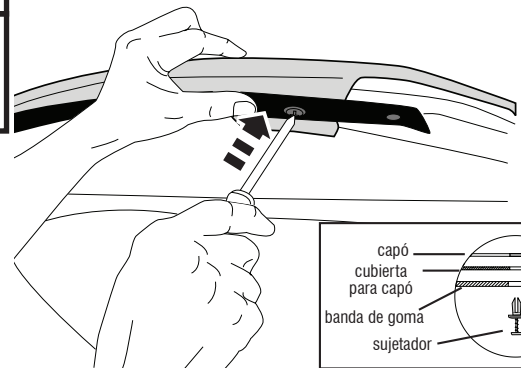

6

Instale los (4) sujetadores restantes. **NO AJUSTE DEMASIADO.**

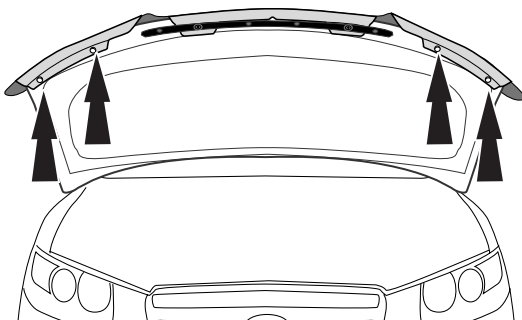
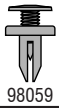

7

Cierre el capó. Coloque (4) soportes en las áreas de la superficie del capó que limpió previamente.

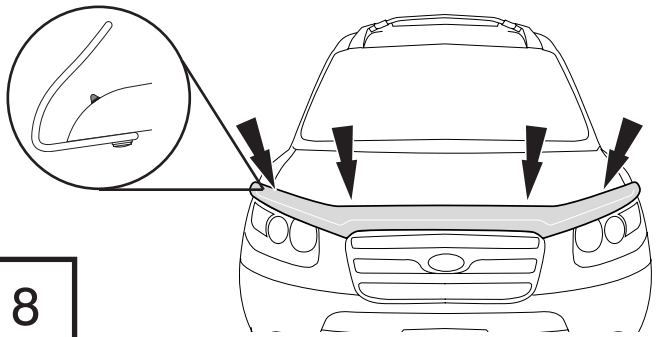

8

Cuidado y limpieza

- Limpie solamente con agua jabonosa tibia y seque con un paño limpio.

Felicidades

Usted ha comprado uno de los tantos artículos de calidad de Auto Ventshade™ ofrecidos por Lund International, Inc. Nuestros productos son nuestro mayor orgullo. Deseamos que disfrute de años de satisfacción con su inversión. Hemos realizado todos los esfuerzos para asegurarnos de que su producto sea de la mejor calidad en cuanto a ajuste, durabilidad, acabado y facilidad de instalación.



Lund International

800-241-7219 • Visite nuestro sitio Web: lundinternational.com

© 2012 Lund International, Inc. Todos los derechos reservados.



Auto Ventshade™, el logo de Auto Ventshade™ y el logo de AVS™ son marcas comerciales de Lund International, Inc.

