

Installation Instructions

I - Sheet Number BF26 Rev.B



Bugflector® - Bugflector II® - Carflector® - Chrome Hood Shield™

For proper installation and best possible fit, please read all instructions **BEFORE** you begin.
For technical assistance or to obtain missing parts, please call Customer Relations at 1-800-241-7219.

Important Safety Information



- CAUTION - Before driving, ensure that the hood shield is properly secured to vehicle.
- Do not use automatic "brush-style" car washes.
- Do not use cleaning solvents of any kind.
- Periodically check all components for tightness.

Contents - 1 Piece Set

NOTE: Actual product may vary from illustration.



Hood shield



Bump On x4



Fastener x4

Contents - 3 Piece Set



Hood shield



Fender Protector x2



Bump On x4



Fastener x4



Alcohol Pad x2

Tools Required



Car Wash Supplies



Clean Towel

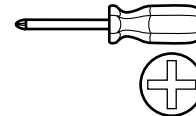

Phillips screwdriver

Preparation Before Painting / Installation

- A trial fit is recommended to ensure proper positioning and fit.
- Check fit of parts before painting as we will not accept the return of modified or painted parts.
- Wash and dry your vehicle to remove any debris and/or dirt from the installation area.

Installation Steps

NOTE: Actual application may vary slightly from illustrations.

Locate (4) circular holes on the underside of the front grill.
Remove any dust or debris,

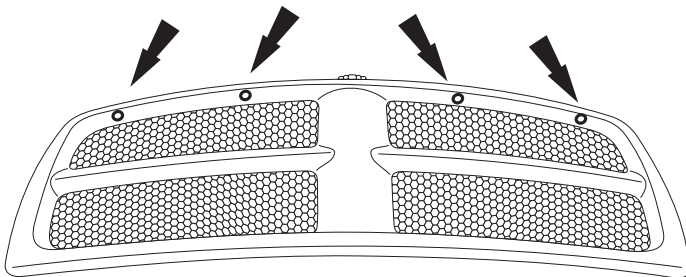

1

Align the predrilled holes in the hoodshield with the holes in the underside of grill.

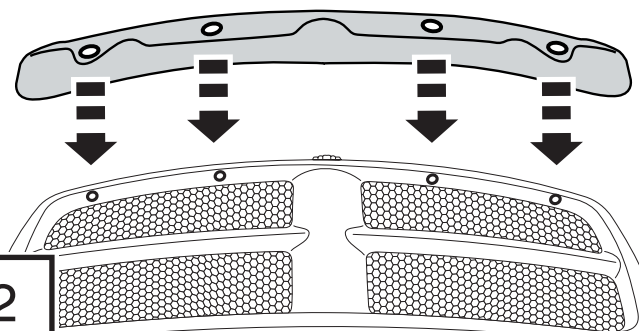

2

Installation Steps

NOTE: Actual application may vary slightly from illustrations.

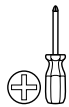

Using a phillips screwdriver, install the fastener

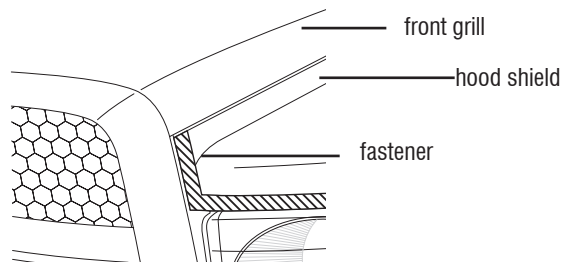
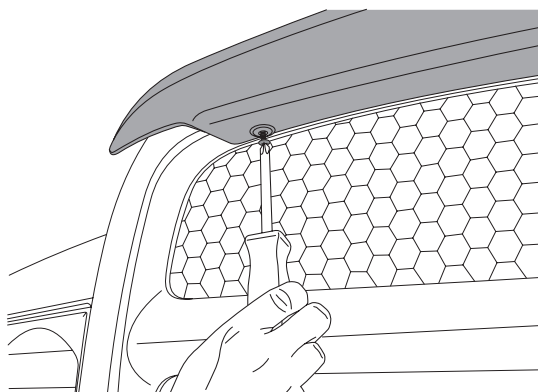

3

DO NOT OVERTIGHTEN

Fender Protector Installation

Clean the fender protector mounting location with an alcohol pad.

Alcohol Pad

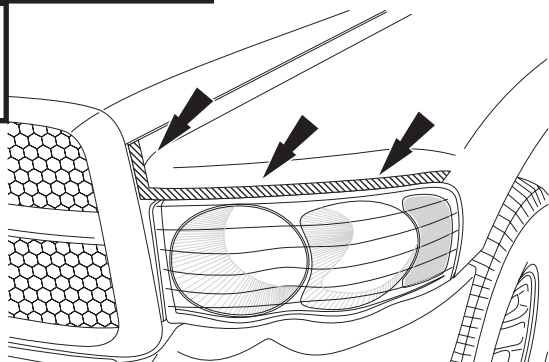

4

Expose 2" (5 cm) of tape liner from each end of the flanges on the fender protector.

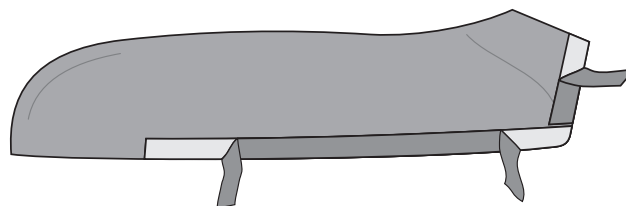

5

Align fender protector with front edge of fender. With the fender protector in final position, remove the remainder of the tape liner by pulling on loose ends. Press firmly on flanges to ensure adhesion.

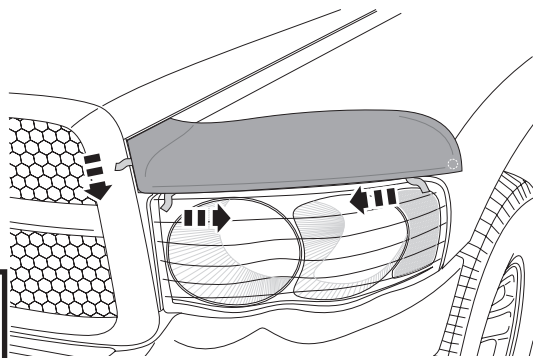

6

Apply bump on as indicated.

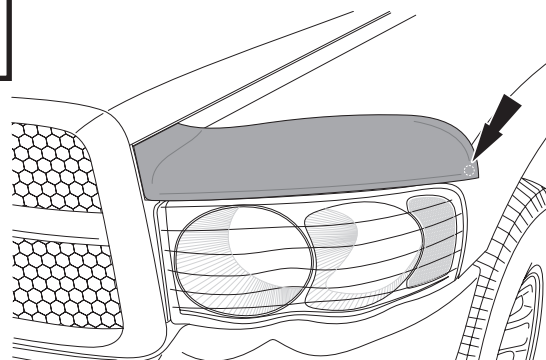

7

Repeat Steps 4-7 for passenger side fender protector.

Care and Cleaning

- Wash only with mild soap & dry with a clean cloth.

Congratulations!

You have purchased one of the many quality Auto Ventshade™ branded products offered by Lund International, Inc. We take the utmost pride in our products and want you to enjoy years of satisfaction from your investment. We have made every effort to ensure that your product is top quality in terms of fit, durability, finish and ease of installation.



AUTO VENTSHADE™

Lund International, Ventshade Accessories Division

655 Raco Drive, Lawrenceville, GA 30045

800-241-7219 • Fax 770-339-5839 • Visit us at lundinternational.com

© 2006 Lund International, Inc. All rights reserved.



Auto Ventshade™, the Auto Ventshade™ logo, Chromelector™, and the AVS™ logo are trademarks of Lund International, Inc.



Instructions d'installation

I- Feuille numéro BF26 Rév.B



Bugflector® - Bugflector II® - Carflector® - Chrome Hood Shield™

Pour obtenir une installation correcte et le meilleur ajustement possible, lire toutes les instructions AVANT de commencer. Pour toute assistance technique ou obtention de pièces manquantes, appeler le service des relations avec la clientèle au 1-800-241-7219.

Informations importantes concernant la sécurité



- ATTENTION – Avant de conduire, s'assurer que le pare-insectes est solidement assujettie sur le véhicule.
- Ne pas utiliser les stations de lavage de voitures à brosse.
- Ne pas utiliser de solvants.
- Vérifier régulièrement le serrage des composants.

Contenu

NOTE: Le produit réel peut changer de l'illustration.



Pare-insectes



Butoirs (4)



Attache (2)

Contenu - ensemble de 3 morceaux



Pare-insectes



protecteur d'amortisseur (2)



Butoirs (4)



Attache (2)



Tampons à l'alcool (2)

Outils nécessaires



Fournitures pour lavage de voiture



Serviette propre

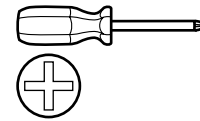

Tournevis Phillips

Préparation pour la peinture/l'installation

- Il est recommandé de procéder à un essai pour s'assurer que le positionnement et l'ajustement sont corrects.
- Vérifier l'ajustement des pièces avant peinture, car nous n'acceptons pas le retour de pièces modifiées ou peintes.
- Laver les glissières de glaces de la portière du véhicule pour éliminer toute poussière et tous débris.
- Sécher les glissières avec une serviette propre.

Étapes d'installation

REMARQUE : La méthode d'application peut être légèrement différente de celle représentée par les illustrations.

Localiser les (4) trous circulaires du dessous de la calandre avant. Nettoyer pour éliminer la poussière et les débris.

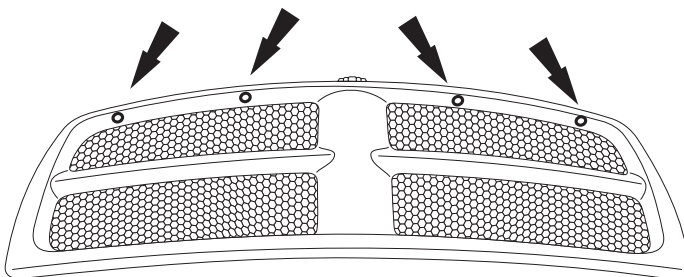

1

Aligner les trous prépercés du pare-insectes et ceux du dessous de la calandre.

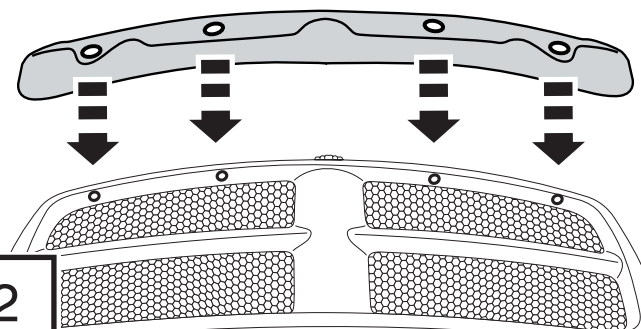

2

Étapes d'installation

REMARQUE : La méthode d'application peut être légèrement différente de celle représentée par les illustrations.



Installer la fixation à l'aide d'un tournevis cruciforme.

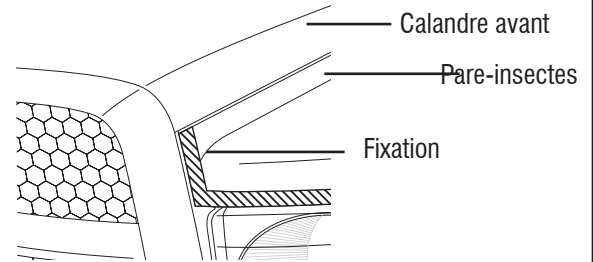
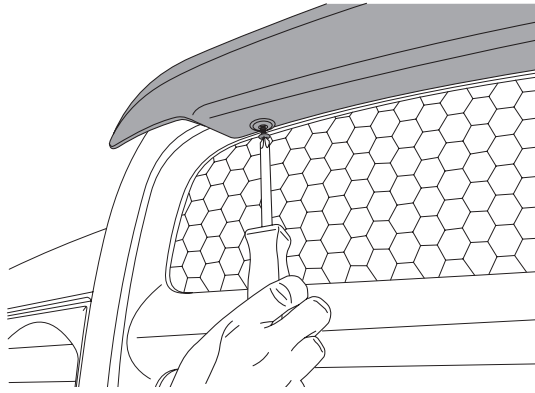

3

NE PAS TROP SERRER

Installation de la protection d'aile

Nettoyer la surface de montage de la protection d'aile avec un tampon à l'alcool.

Alcohol Pad

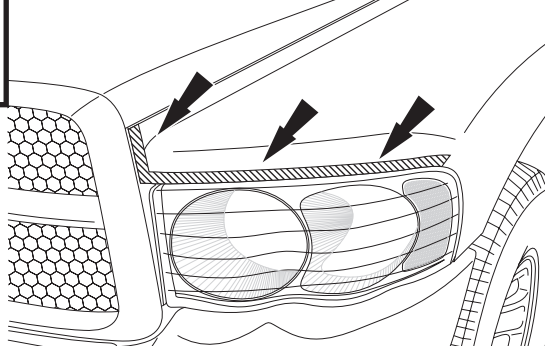

4

Décoller 5 cm (2 po) de protection d'adhésif de chacune des extrémités de la protection d'aile.

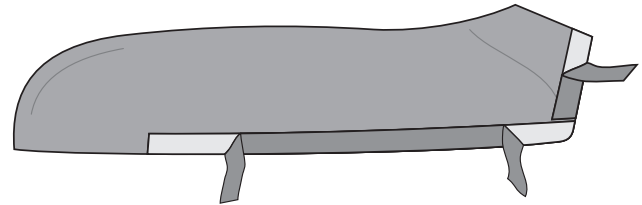

5

Aligner la protection d'aile et le bord avant de l'aile. Une fois la protection d'aile en position finale, retirer le reste de la protection d'adhésif en tirant sur ses extrémités libres. Appuyer fermement sur les rebords pour assurer une bonne adhésion.

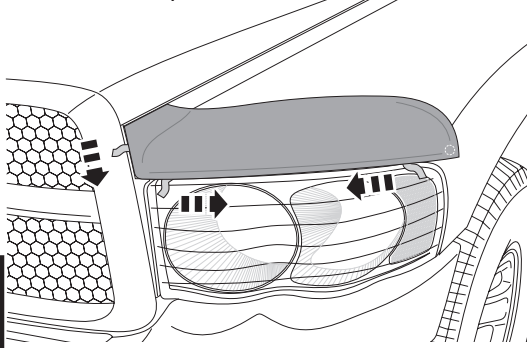

6

Appliquer le butoir comme indiqué.

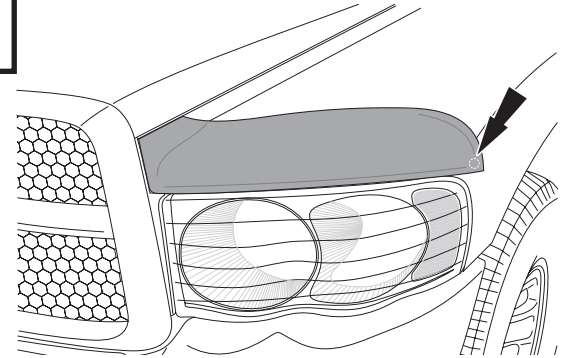

7

Répéter les étapes 4 à 7 pour la protection d'aile du côté passager.

Entretien et nettoyage

- Laver exclusivement avec de l'eau savonneuse et sécher avec un chiffon propre.

Félicitations !

Vous avez acheté l'un des nombreux produits de qualité Auto Ventshade™ fabriqués par Lund International, Inc. Nous sommes extrêmement fiers de nos produits et souhaitons que vous tiriez des années de satisfaction de votre investissement. Nous avons pris toutes les mesures nécessaires pour assurer que ce produit est d'une qualité supérieure en ce qui concerne l'ajustement, la durabilité, la finition et la facilité d'installation.



AUTO VENTSHADE™
Lund International, Ventshade Accessories Division
655 Raco Drive, Lawrenceville, GA 30045, USA

800-241-7219 • Fax 770-339-5839 • Visitez notre site lundinternational.com

© 2006 Lund International, Inc. Tous droits réservés.



Auto Ventshade™ le logo Auto Ventshade™, Chromeflector™ et le logo AVS™ sont des marques déposées de Lund International, Inc.



Instrucciones de instalación

Hoja informativa N.º BF26 Rev. B



Bugflector® - Bugflector II® - Carflector® - Chrome Hood Shield™

Para una instalación adecuada y el mejor ajuste posible, lea todas las instrucciones ANTES de comenzar. Si desea recibir asistencia técnica u obtener piezas faltantes, llame al Servicio al cliente al 1-800-241-7219.

Información importante de seguridad



- PRECAUCIÓN - Antes de conducir, asegúrese de que la visera deflectora esté correctamente anclada al vehículo.
- No utilice servicios automáticos de limpieza de vehículos que utilizan cepillos.
- No utilice limpiadores al solvente de ningún tipo.
- Compruebe periódicamente que todos los componentes estén ajustados.

Contenido **NOTA:** El producto real puede variar de la ilustración.



Cubierta para capó



Soporte (2)



Sujetador (4)

Contenido - sistema de 3 pedazos



Cubierta para capó



protector de la defensa (2)



Soporte (2)



Sujetador (4)



Paños esterilizados (2)

Herramientas necesarias



Equipo de limpieza de vehículos



Toalla limpia

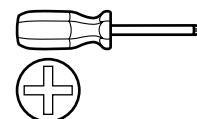

Destornillador Phillips

Preparación antes de pintar o instalar

- Se recomienda realizar un ajuste de prueba para asegurar el posicionamiento y ajuste correctos.
- Compruebe que las piezas se ajusten correctamente antes de pintarlas, ya que no aceptaremos la devolución de piezas modificadas o pintadas.
- Lave los canales de la ventanilla del vehículo para quitar los desechos y la suciedad.
- Seque los canales de la ventanilla con una toalla limpia.

Pasos de instalación **NOTA:** El uso real puede variar levemente de ilustraciones.

Ubique los (4) orificios circulares en la parte inferior de la parrilla delantera. Quite los desechos o la suciedad.

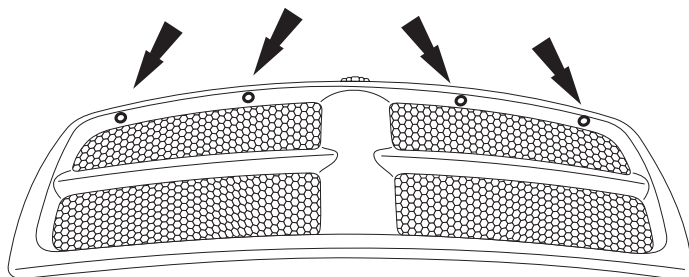

1

Alinee los orificios realizados previamente en la cubierta para capó con los orificios de la parte inferior de la parrilla.

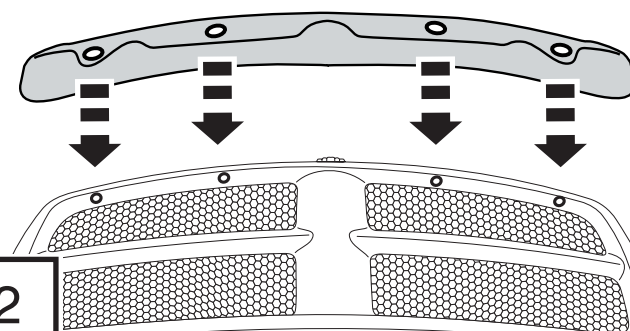

2

Pasos de instalación

NOTA: El uso real puede variar levemente de ilustraciones.

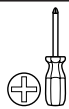

Con un destornillador Phillips, coloque el sujetador.

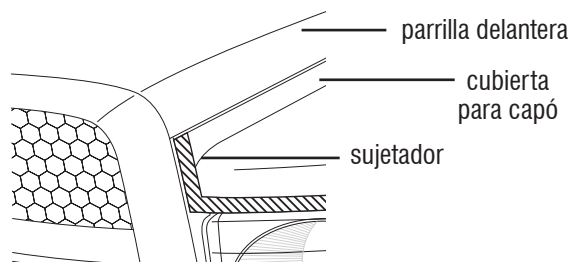
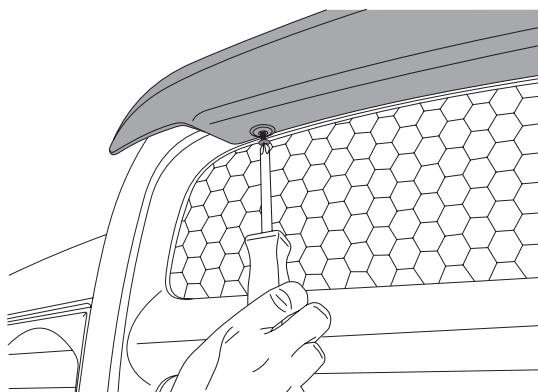

NO AJUSTE DEMASIADO

3

Instalación del protector de guardabarros

Limpie el lugar donde colocará el protector de guardabarros con un paño esterilizado.

Alcohol Pad

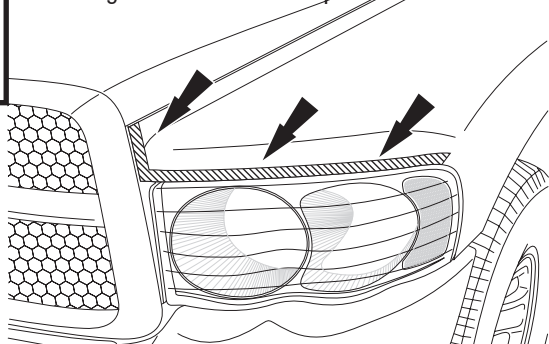

4

Exponga 2" (5 cm) de cinta protectora en cada extremo de los rebordes del protector de guardabarros.

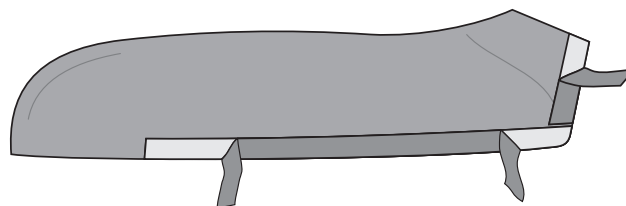

5

Alinee el protector de guardabarros con el borde delantero del guardabarros. Una vez que el protector de guardabarros se encuentra en su posición definitiva, quite la cinta protectora restante tirando de los extremos que quedaron libres. Presione firmemente sobre los rebordes para asegurarse de que se adhieran correctamente.

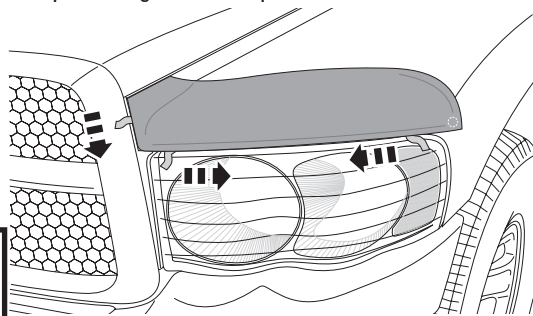

6

Coloque los soportes como se indica.

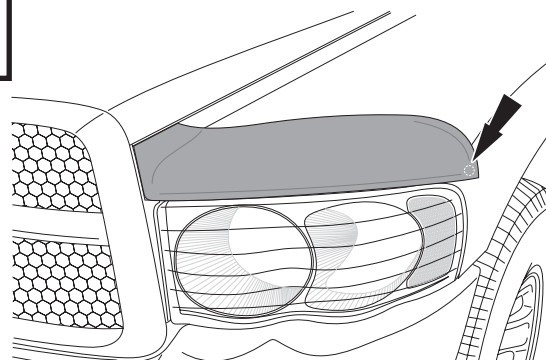

7

Repita los pasos 4 a 7 para el protector de guardabarros del lado del acompañante.

Cuidado y limpieza

- Limpie solamente con agua jabonosa tibia y seque con un paño limpio.

Felicidades

Usted ha comprado uno de los tantos artículos de calidad de Auto Ventshade™ ofrecidos por Lund International, Inc. Nuestros productos son nuestro mayor orgullo. Deseamos que disfrute de años de satisfacción con su inversión. Hemos realizado todos los esfuerzos para asegurarnos de que su producto sea de la mejor calidad en cuanto a ajuste, durabilidad, acabado y facilidad de instalación.



AUTO VENTSHADE™

Lund International, Ventshade Accessories Division

655 Raco Drive, Lawrenceville, GA 30045

800-241-7219 • Fax 770-339-5839 • Visite nuestro sitio Web: lundinternational.com

© 2006 Lund International, Inc. Todos los derechos reservados.



™ Auto Ventshade™ el logo de Auto Ventshade™, Chromeflector™ y el logo de AVS™ son marcas comerciales de Lund International, Inc.

