



Installation Instructions

For Part Numbers:

450-326 700-495 Airaid Oiled Media Filter

451-326 701-495 SynthaMax Dry Media Filter - Red

452-326 702-495 SynthaMax Dry Media Filter - Black

453-326 703-495 SynthaMax Dry Media Filter - Blue

2015 Ford Mustang

2.3L EcoBoost 4cyl

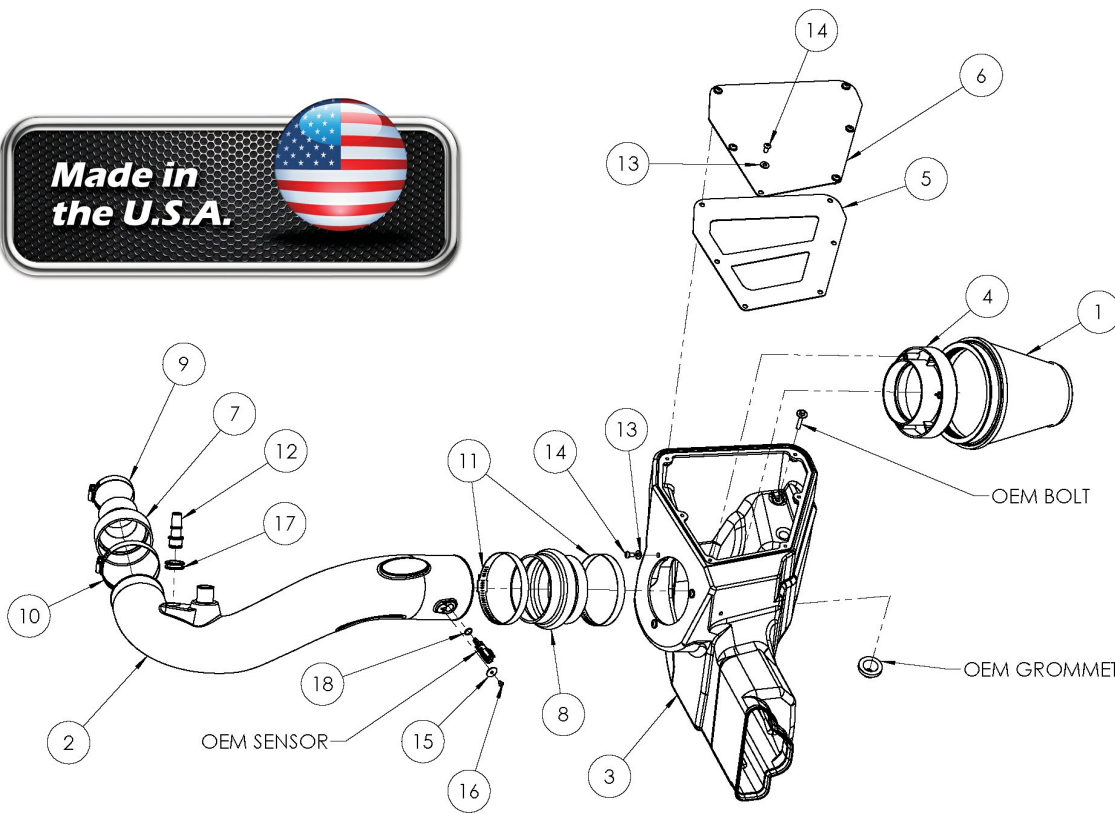

Component Identification

| | | |
|----|---------------------------|---|
| 1 | Airaid Premium Filter | 1 |
| 2 | Airaid Intake Tube | 1 |
| 3 | Cold Air Box | 1 |
| 4 | Filter Adapter | 1 |
| 5 | Air Box Lid | 1 |
| 6 | Window | 1 |
| 7 | Reducing Coupler | 1 |
| 8 | Hump Hose | 1 |
| 9 | Hardware and Instructions | 1 |
| 9 | #40 Hose Clamp | 1 |
| 10 | #56 Hose Clamp | 1 |
| 11 | #68 Hose Clamp | 2 |
| 12 | Aluminum Fitting | 1 |
| 13 | 1/4" Flat Washer | 9 |
| 14 | 1/4"-20 Button Head Screw | 9 |
| 15 | #8 Flat Washer | 1 |
| 16 | Button Head Screw | 1 |
| 17 | Grommet | 1 |
| 18 | O Ring | 1 |
| 19 | Airaid Decal | 1 |

Full color instructions can be viewed on our web site at Airaid.com. Use the **Product Search** function to find your part number, and click **View Details**.

FILTER IDENTIFICATION

700-495 Airaid Oiled Media
702-495 Airaid SynthaMax Dry Media - Black

701-495 Airaid SynthaMax Dry Media - Red
703-495 Airaid SynthaMax Dry Media - Blue



1. Remove the battery box cover in the cowl and disconnect the negative battery terminal.

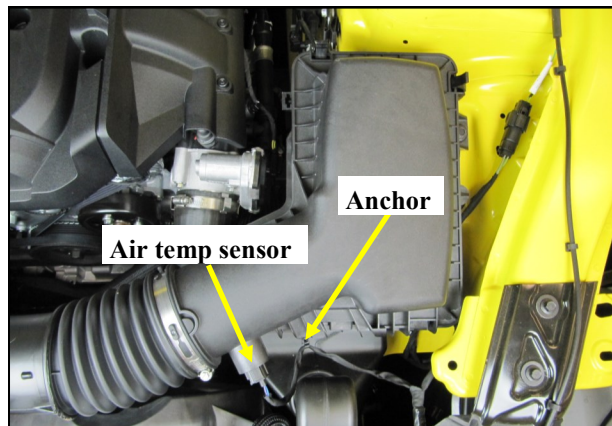

2. Loosen the clamp on the intake tube and slide it off of the airbox. Gently pry the harness anchor out of the airbox and disconnect the air temp sensor.

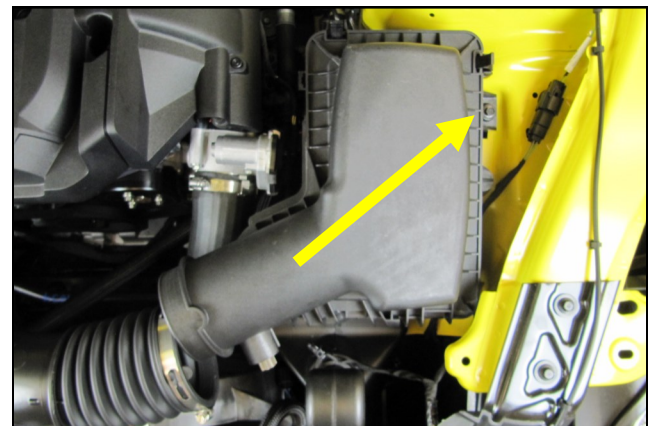

3. Remove the 6mm airbox mounting bolt in the inner fender and lift the entire airbox assembly out of the vehicle. Set the bolt aside for now. It is to be reused.

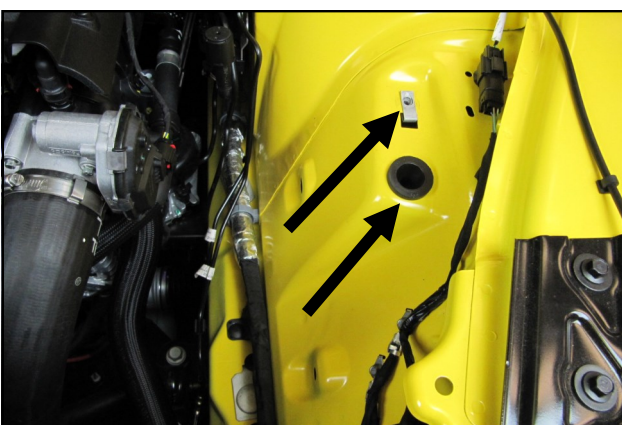

4. Be sure the speed clip and the airbox grommet remain inside the vehicle. They will be reused.

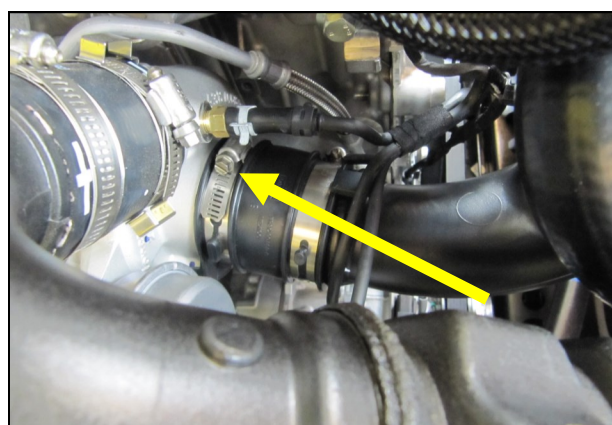

5. Loosen the clamp on the turbo inlet coupler.

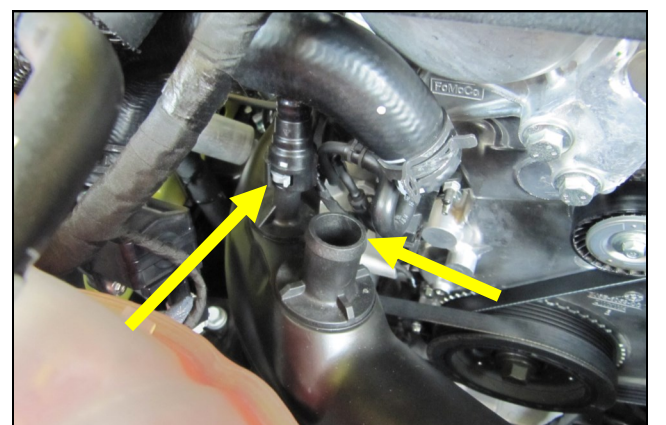

6. Disconnect the PCV and turbo bypass lines from the intake tube and remove the tube from the vehicle.

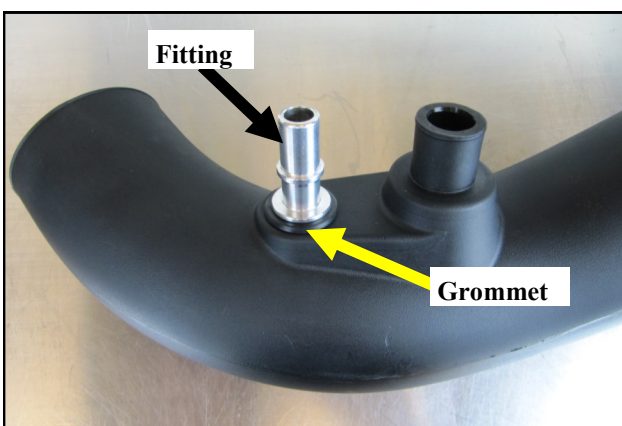

7. Insert the Grommet and Aluminum Fitting into the Airaid Intake tube as shown.

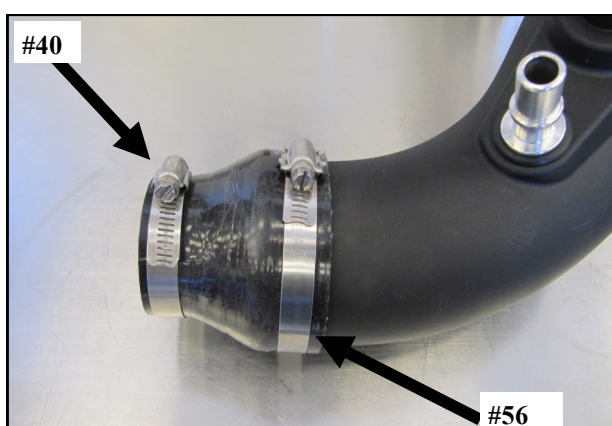

9. Slide the Reducer and Clamps onto the turbo side of the Intake Tube as shown. Leave the clamps loose for now.

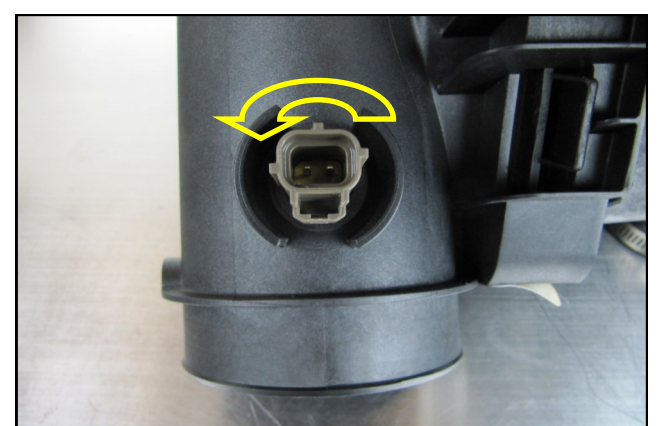

8. Tilt the air temp sensor rearward so the locking tab clears the ramp and rotate it counterclockwise 1/4 turn to release it.

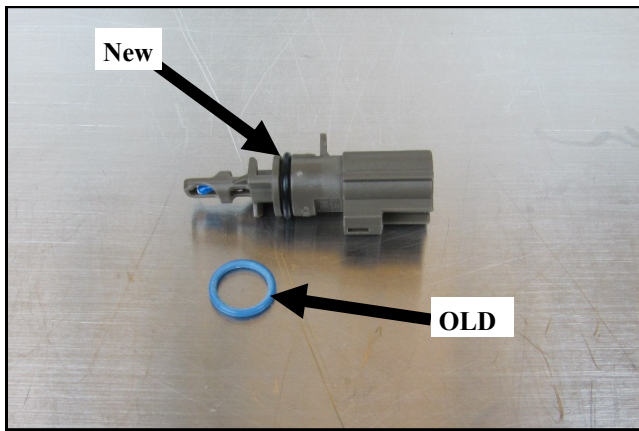

10. Replace the OEM O ring on the sensor with the supplied Airaid O ring.

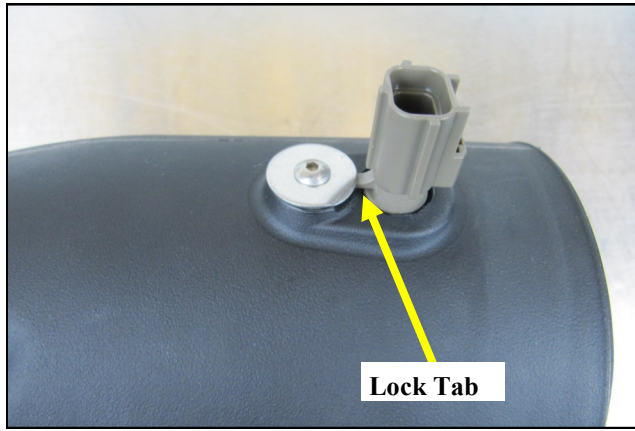

11. Insert the air temperature sensor into the Airaid intake tube as shown and secure it using the #8 Screw and Washer.

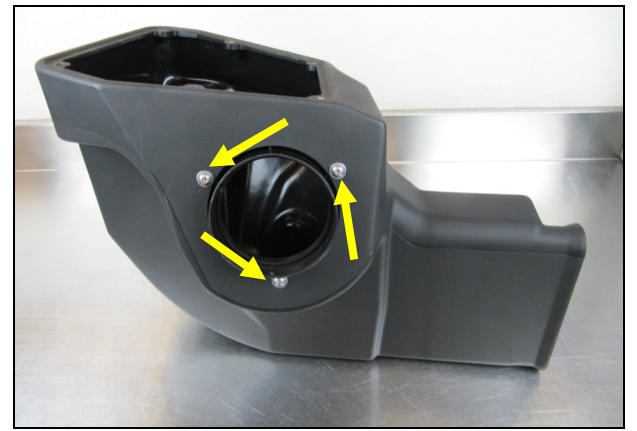

12. Install the Filter Adapter onto the Cold Air Box as shown using the three 1/4-20 Button Head Screws and 1/4" Flat Washers.

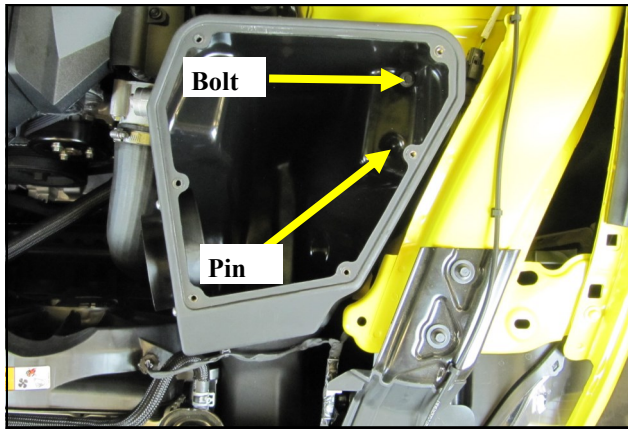

13. Place the Airaid Airbox assembly into the engine compartment as shown with the locator pin on the bottom of the box inside the fender grommet. Secure the airbox by reusing the 6mm bolt removed in step # 3.



14. Slide the Hump Hose and Clamps onto the Filter Adapter as shown. Do not tighten the clamps at this time.

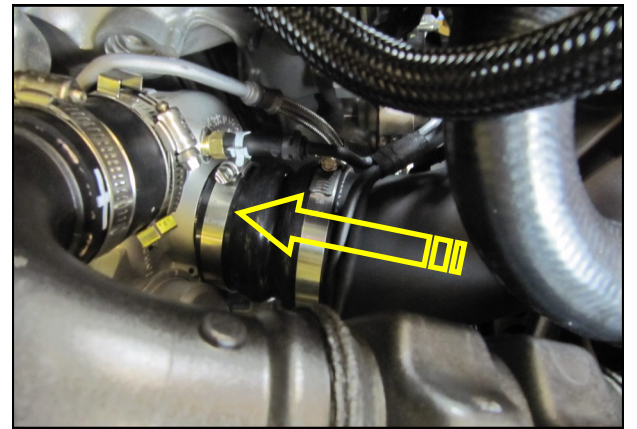

15. Lower the Airaid Intake tube down into position and slide the reducer onto the turbo inlet.

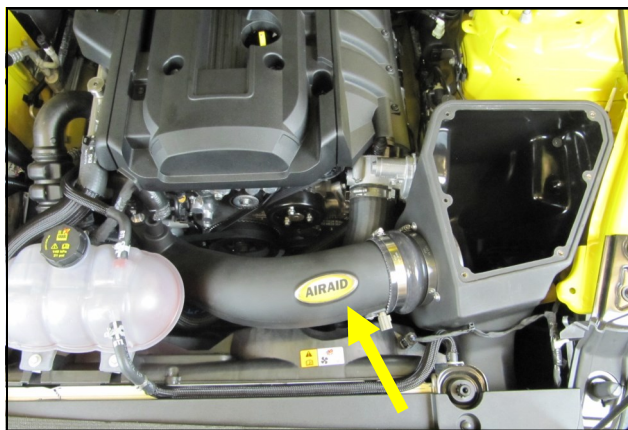

16. Insert the large end of the Intake Tube into the Hump Hose and tighten all 4 Intake Clamps at this time. Apply the Airaid Decal to the tube as shown.

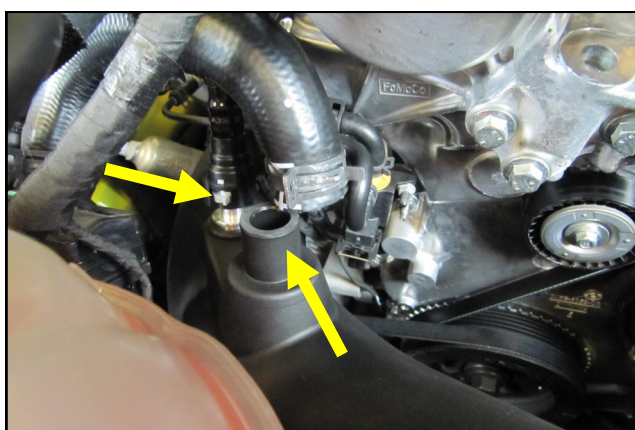

17. Reconnect the PCV and bypass line to the Airaid Intake Tube.

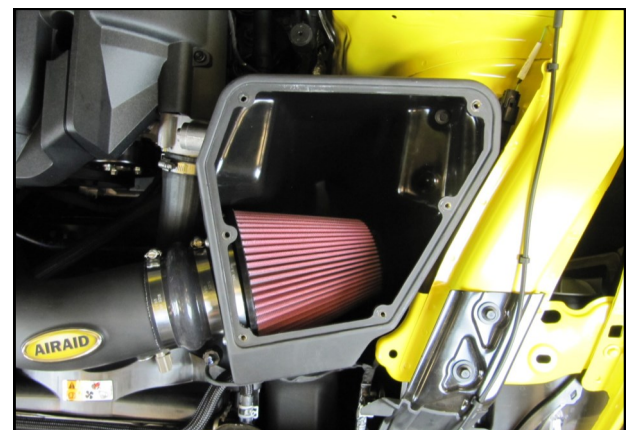

18. Install the Airaid Premium Filter onto the Filter Adapter inside of the Airbox.



19. Remove the protective film from the Lid and Window before installation. Install the Airbox lid and Window onto the Airbox, with the Window on top, using 6 sets of 1/4" Button Heads and Washers.

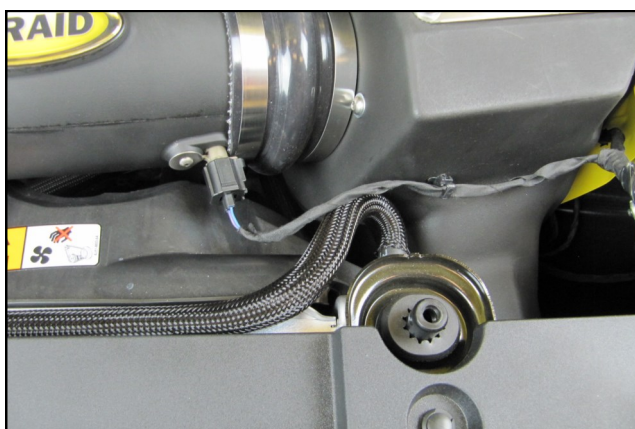

20. Reconnect the air temp sensor and plug the wire harness anchor into the Airbox.



21. **Double check your work.** Make sure all clamps, hoses, bolts, and screws are tight. Double check the hood clearance. Reconnect the negative battery cable and reinstall the cover.

Thank you for purchasing the Airaid Intake System. Contact Airaid @ (800) 498-6951 8:00 AM - 5:00 PM MST weekdays for questions regarding fit or instructions that are not clear to you. Your Airaid Intake System was carefully inspected and packaged. Check that no parts are missing, or were damaged during shipping. If any parts are missing, contact Airaid. The air filter element is protected from direct exposure to water and debris; care should be taken not to drive through deep water. WATER INGESTION IS THE DRIVERS RESPONSIBILITY! The air filter is reusable and should be cleaned periodically.

For your Oiled media filter we suggest using the AIRAID Filter Tune-Up Kit!



SynthaMax

Synthamax Air Filters do not require oil. Service air filter as needed by cleaning with common non-petroleum all-purpose household cleaner and water. Simple Green®, Formula 409® or equivalent works great. Apply cleaner to outside of air filter and allow to soak. Then flush filter clean from the inside out with a garden hose and repeat steps if necessary. Do not apply high pressure water or air to clean filter.