

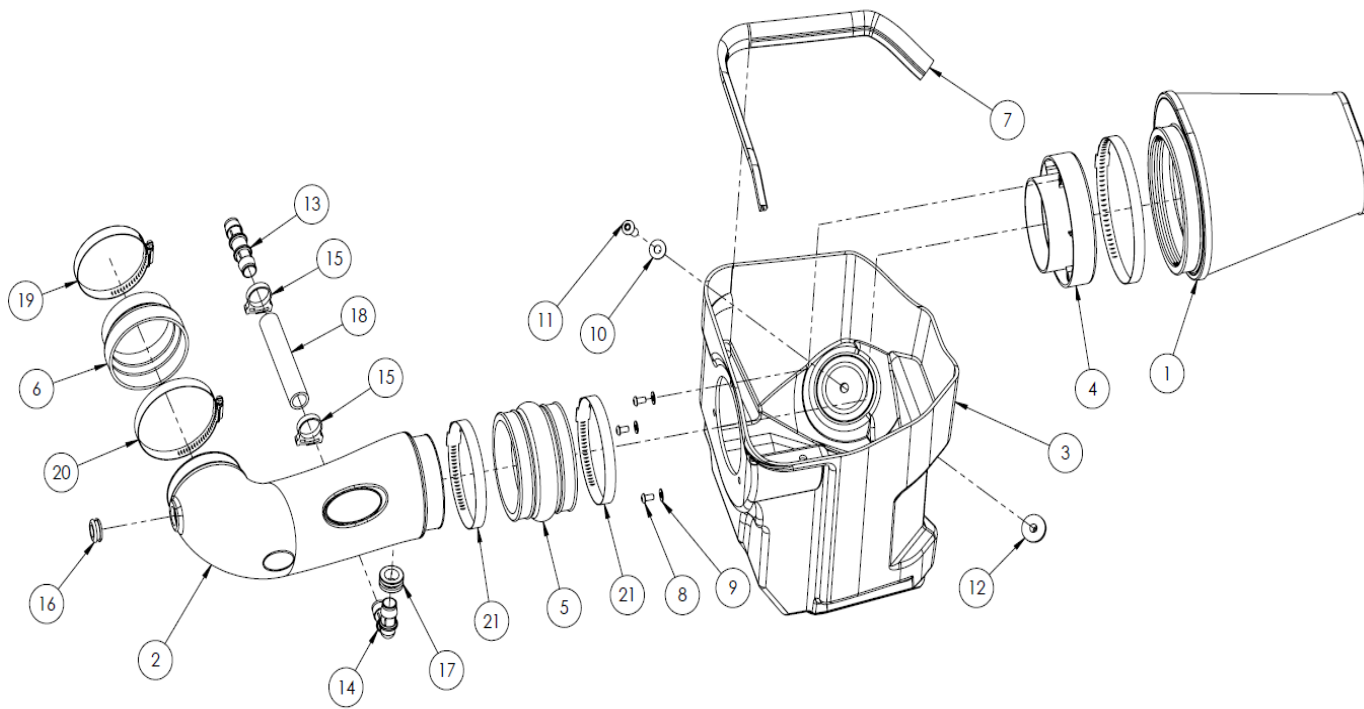

Installation Instructions

For Part Numbers:

350-318 720-127 Airaid Oiled Media Filter
 351-318 721-127 SynthaMax Dry Media Filter - Red
 352-318 722-127 SynthaMax Dry Media Filter - Black
 353-318 723-127 SynthaMax Dry Media Filter - Blue
2011-15 Chrysler 300
2011-15 Dodge Challenger
2011-15 Dodge Charger
5.7L V8



Component Identification

1.	Airaid Premium Filter	1
2.	Airaid Intake Tube	1
3.	Cool Air Box	1
4.	Filter Adapter	1
5.	Hump Hose	1
6.	Reducing Coupler	1
7.	Weatherstrip	1
8.	1/4"-20 Button Head Screw	3
9.	1/4" Flat Washer	3
10.	5/16" Flat Washer	1
11.	3/8" Button Head Screw	1
12.	3/8" Well Nut	1
13.	Barbed Fitting	1
14.	Barbed Elbow	1
15.	Speed Clamp	2
16.	9/16" Grommet	1
17.	3/4" Grommet	1
18.	PCV Hose	1
19.	#56 Hose Clamp	1
20.	#64 Hose Clamp	1
21.	#72 Hose Clamp	2
22.	Airaid Decal	2

Full color instructions can be viewed on our web site at Airaid.com.



1. Disconnect the negative battery terminal, located in the trunk, by the spare tire.

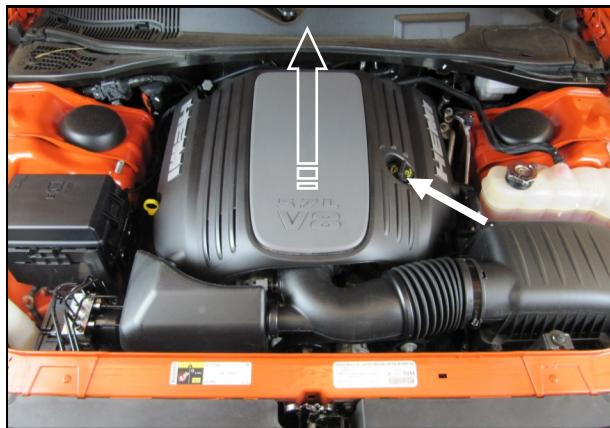

2. Remove the oil cap and lift up on the engine cover to unseat it from the mounting grommets. Replace the oil cap and set the cover aside.

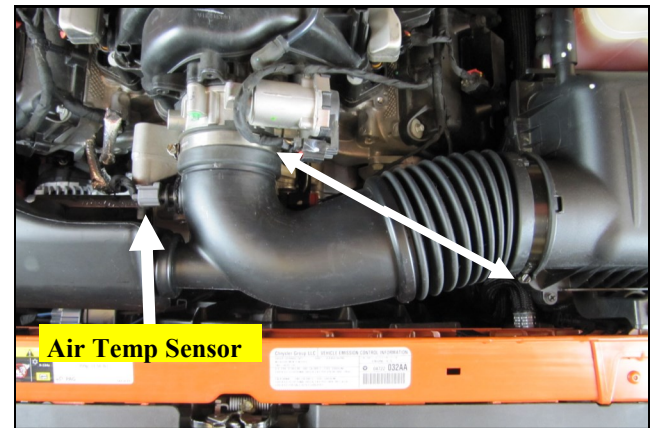

3. Disconnect the air temperature sensor. Loosen the hose clamps on the factory intake tube, unseat the resonator from its mounting grommet, and remove the intake tube.

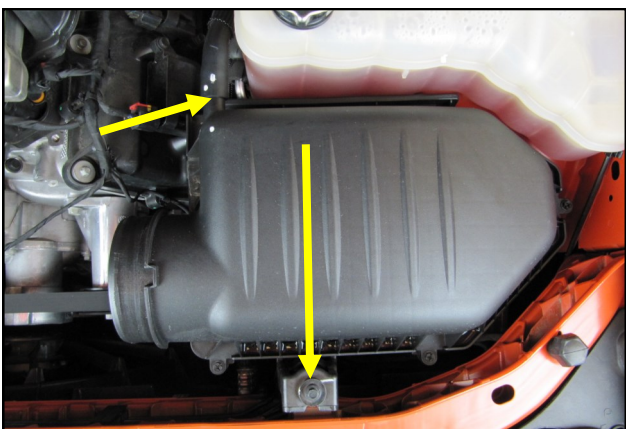

4. Separate the crankcase breather from the air box lid and remove the air box screw in the core support. Lift the air box out of the vehicle and set the screw aside, it will be reused in step 7.

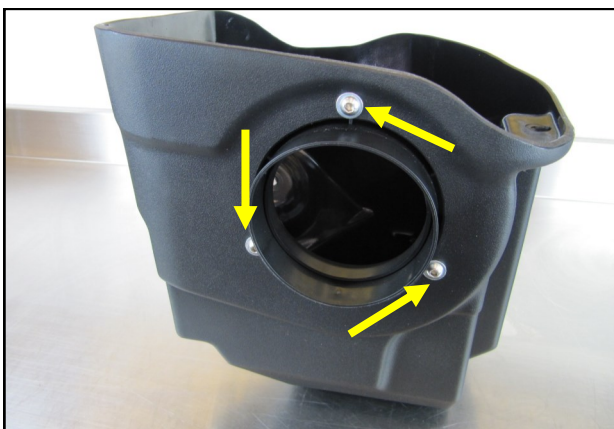

5. Install the Filter Adapter onto the Cool Air Box using the three 1/4" Button Head Screws and 1/4" Flat Washers, (#s 8&9).

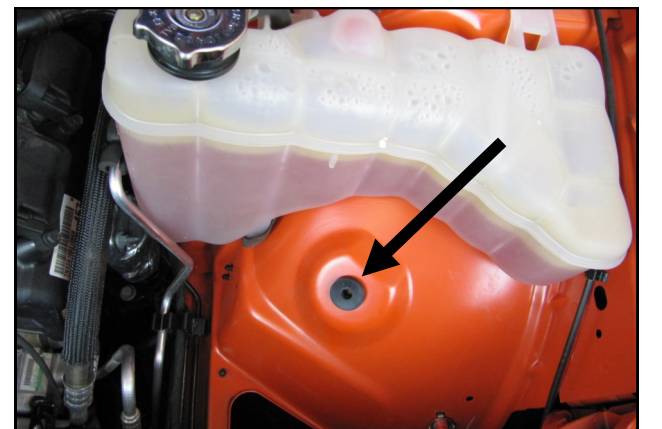

6. Set the Well Nut into the hole in the inner fender.

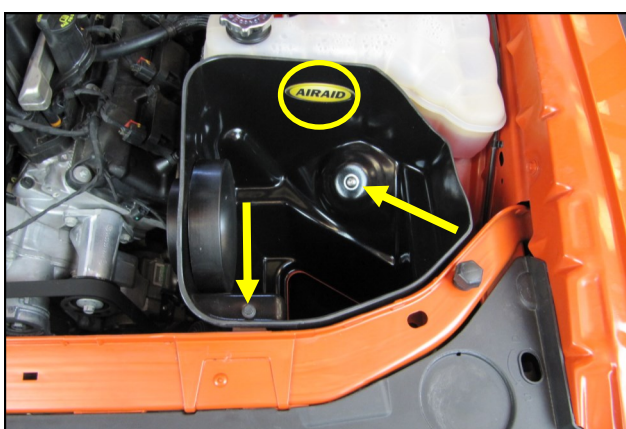

7. Lower the Air Box assembly down into the inner fender. Align the bolt holes and secure the Air Box using the screw removed in step 4 and the 3/8" Button Head Screw with the 5/16" Flat Washer. Apply the Airaid Decal inside the Airbox as shown.



8. Insert the 9/16" Grommet into the Airaid Intake tube and shown. Transfer the air temperature sensor from the factory intake tube into the Airaid Intake Tube.



9. Insert the 3/4" Grommet and Barbed Elbow into the Airaid Intake Tube as shown.

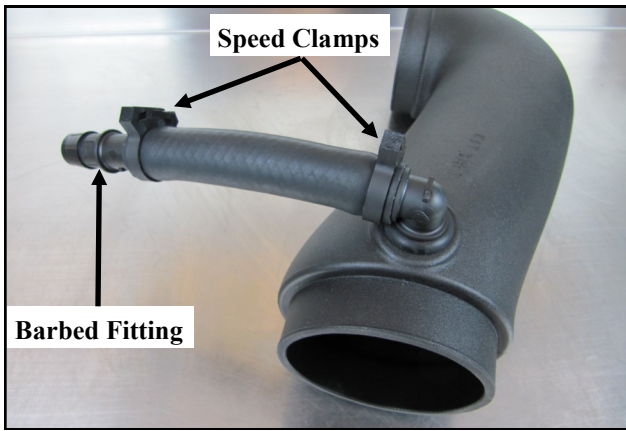

10. Insert the Barbed Fitting into the supplied PCV Hose and connect it to the Elbow in the Intake Tube. Use the Speed Clamps to secure the Hose onto the Fittings.

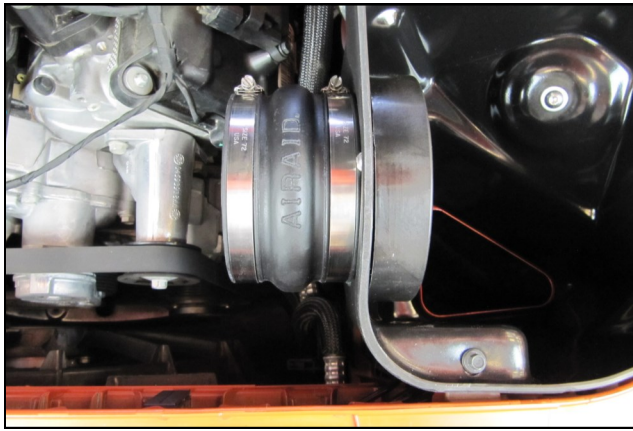

11. Slide the Hump Hose and the # 72 Clamps onto the Filter Adapter. Leave the Clamps loose for now.

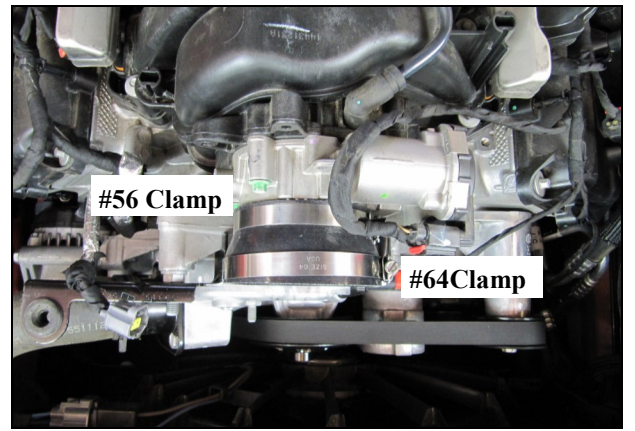

12. Slide the Reducing Coupler and the # 56 and 64 Clamps onto the throttle body. Leave the Clamps loose for now.



13. Insert the Intake Tube assembly into the Hump Hose first, then into the Coupler onto the throttle body. Tighten all four Clamps at this time. Apply the second Airaid Decal onto the Intake tube.

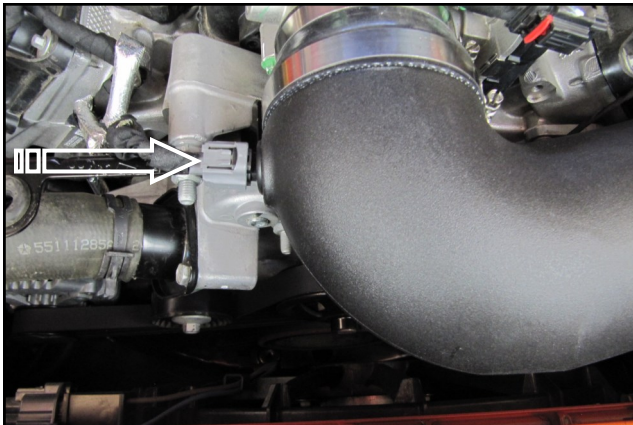

14. Reconnect the air temperature sensor.

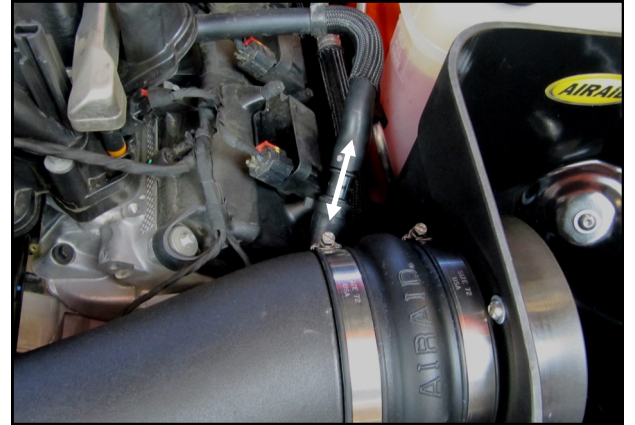

15. Connect the Barbed Fitting in the PCV hose to crank case breather line in the valve cover .



16. Install the Airaid Premium Filter onto the Filter Adapter.



17. Install the Weatherstrip onto the top edge of the Air Box with the contour rolling away from the Filter.



18. Reinstall the engine cover and oil cap. Reconnect the negative terminal on the battery.

19. Double check your work.

Make sure there is no foreign material in the intake path. Make sure all clamps, hoses, bolts, and screws are tight. Double check the hood clearance!

Thank you for purchasing the Airaid Intake System. Contact Airaid @ (800) 498-6951 8:00 AM - 5:00 PM MST weekdays for questions regarding fit or instructions that are not clear to you. Your Airaid Intake System was carefully inspected and packaged. Check that no parts are missing, or were damaged during shipping. If any parts are missing, contact Airaid. The air filter element is protected from direct exposure to water and debris; care should be taken not to drive through deep water. WATER INGESTION IS THE DRIVERS RESPONSIBILITY! The air filter is reusable and should be cleaned periodically.

FILTER IDENTIFICATION

- 720-127 Airaid Oiled Media
- 722-127 Airaid SynthaMax Dry Media - Black

- 721-127 Airaid SynthaMax Dry Media - Red
- 723-127 Airaid SynthaMax Dry Media - Blue

For your Oiled media filter we suggest using the AIRAID Filter Tune-Up Kit!



P/N 790-551 Aerosol Spray
P/N 790-550 Squeeze Spray



Do Not Oil

Synthamax Air Filters do not require oil. Service air filter as needed by cleaning with common non-petroleum all-purpose household cleaner and water. Simple Green®, Formula 409® or equivalent works great. Apply cleaner to outside of air filter and allow to soak. Then flush filter clean from the inside out with a garden hose and repeat steps if necessary. Do not apply high pressure water or air to clean filter. Allow filter to air dry and reinstall.