



## Installation Instructions

For Part Numbers:

300-221	700-469 Airaid Oiled Media Filter
301-221	701-469 SynthaMax Dry Media Filter - Red
302-221	702-469 SynthaMax Dry Media Filter - Black
303-221	703-469 SynthaMax Dry Media Filter - Blue

2007-09 Dodge Ram 2500/3500  
6.7L I6 Cummins Diesel

### Component Identification

1.	Airaid Premium Filter	1
2.	Airaid Intake Tube	1
3.	Cool Air Box	1
4.	Filter Adapter	1
5.	Urethane Hump Hose	1
6.	Weather Strip 22"	1
7.	8/32 x 1/2" Button Head Screw	3
8.	#8 Flat Washer	3
9.	1/4-20 Button Head Bolt	3
10.	1/4" Flat Washer	4
11.	5/16-18 x 3/4" Hex Head Bolt	1
12.	5/16" Flat Washer	2
13.	5/16" Flange Nut	1
14.	M8 x 1.25 x 30mm Hex Bolt	1
15.	M6 x 1 x 25mm Hex Bolt	1
16.	3/8-16 Well Nut	1
17.	3/8-16 x 1 1/2" Button Head	1
18.	3/8" Flat Washer	1
19.	#72 Hose Clamp	2
20.	#259 L-Bracket	1
21.	T20 Torx Bit	1
22.	Airaid Decal	1

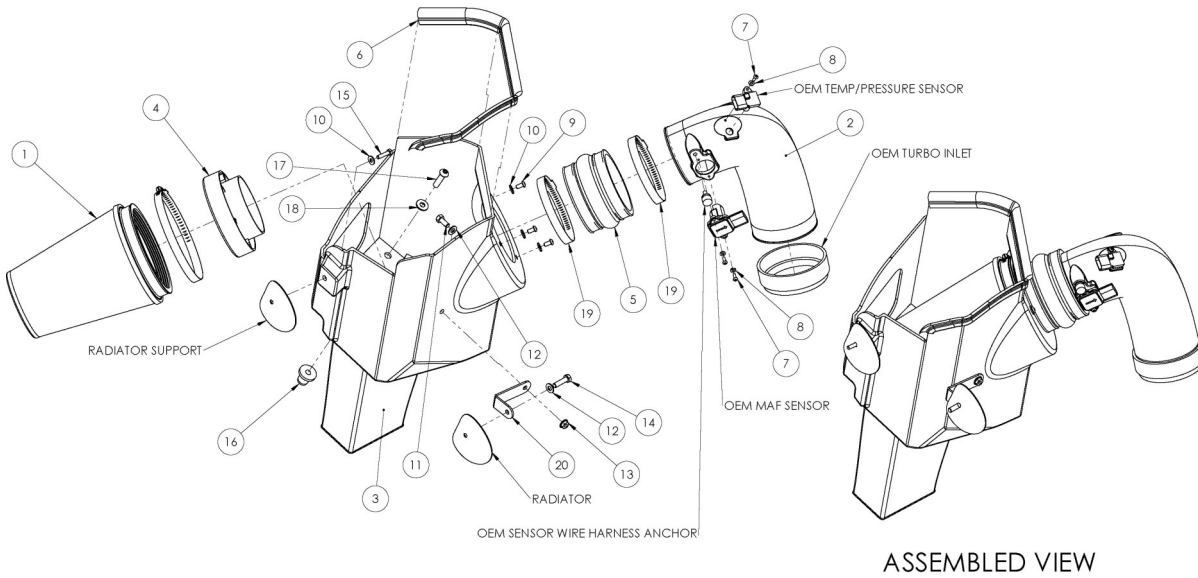

Full color instructions can be viewed on our web site at [Airaid.com](http://Airaid.com).



**1. Disconnect the negative battery cables.**  
A) Using the supplied #20 Torx bit, remove two screws from the Mass Air Flow sensor, and one screw from the temperature sensor. Remove both sensors and the wiring harness anchor from the airbox lid, and set them aside. B) Loosen the hose clamp that holds the factory intake tube to the airbox lid.

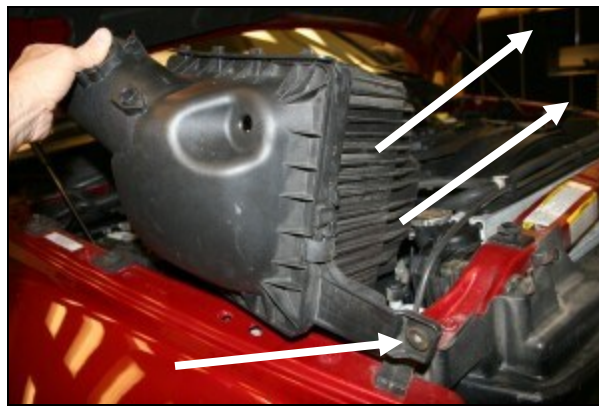

**2.** Using a 10mm socket, remove the nut that secures the factory airbox to the radiator support. Next slide the flexible intake tube off of the factory airbox lid and then rock the factory airbox assembly side to side to release it from the mounting grommets, and remove it from the vehicle.



**3.** Loosen the hose clamp that secures the factory intake tube assembly to the rubber elbow on the turbo inlet, and remove the assembly from the vehicle.

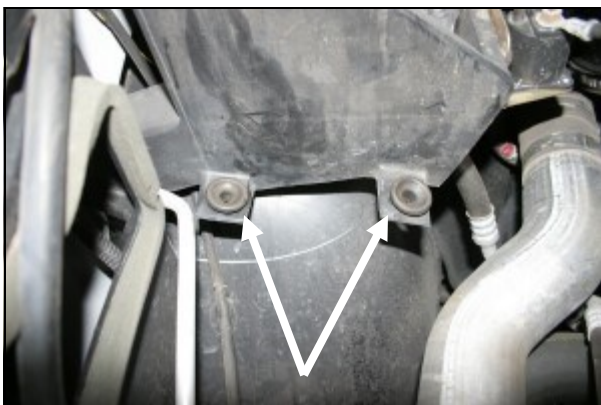

**4.** Remove the two grommets that held the factory airbox in position.

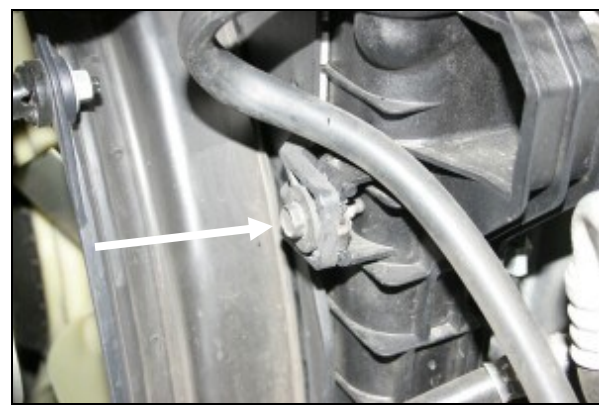

**5.** Using a 13mm socket remove one bolt that secures the fan shroud to the radiator on the passenger side of the vehicle.



**6.** Install the L-bracket (#20) onto the radiator shroud as shown using one M8 x 30mm bolt (#14) and one flat washer (#12) as shown. Leave the bolt slightly loose for now.



**7.** Install the supplied well nut (#16) into the factory airbox mounting hole closest to the fender as shown.



**8.** Install the filter adapter (#4) into the Cool Air Box (#3) using three 1/4" Button Head bolts (#9) and flat washers (#10) as shown.

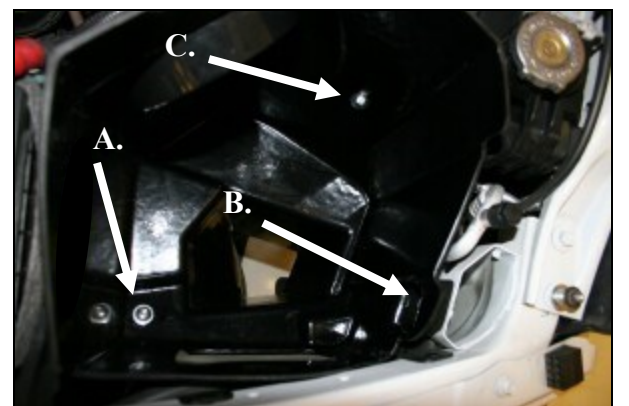

**9.** Install the CAB into the vehicle as shown. A.) Install the 3/8" button head bolt (#17) and flat washer (#18) thru the CAB and into the well nut. B.) Install the M6 x 25mm hex bolt (#15) and flat washer (#10) thru the CAB and into the captured nut in the fender. C.) Install the 5/16" bolt (#11) flat washer (#12), and flange nut (#13) thru the CAB and L-bracket. Tighten all mounting bolts at this time.



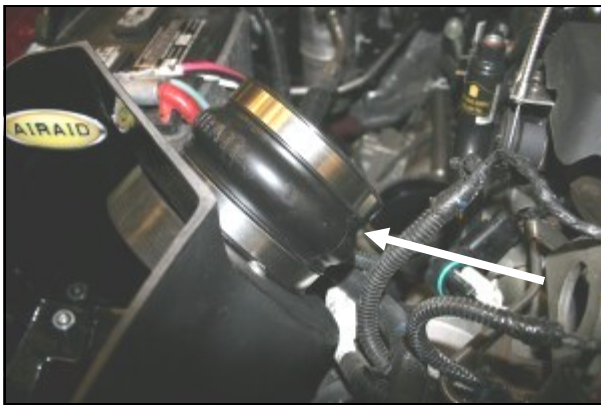

**10.** Install the supplied hump hose (#5) onto the filter adapter using two #72 hose clamps (#19). Leave the clamps loose for now. Apply the Airaid Bubble Decal inside the Airbox as shown.



**11.** Install the Airaid Intake Tube (#2) into the factory turbo elbow and then into the hump hose. Adjust for fit, and then tighten all three hose clamps. Reinstall the intake temperature sensor and Mass Air Flow sensor into the Airaid Intake Tube using three 8-32 button head screws (#7) and #8 flat washers (#8). **Do Not Use The Factory Screws!** Reinstall the factory wiring harness anchor into the hole in the Airaid Intake Tube.

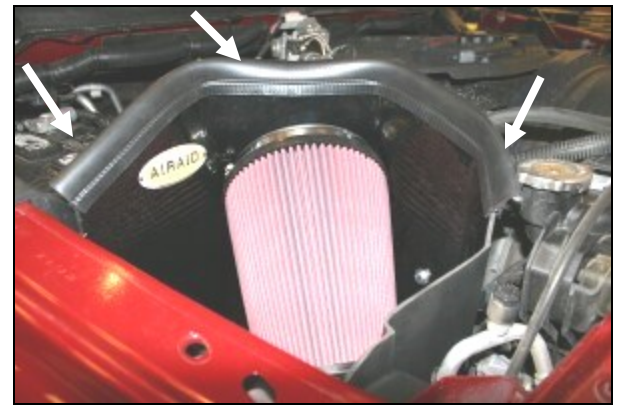

**12.** Install the Airaid Premium Filter (#1) onto the filter adapter and tighten the clamp. Install the weather strip onto the top of the CAB starting at the right fender and working your way towards the radiator.

**13. Double check your work!**

Make sure there is no foreign material in the intake path. Make sure all clamps, hoses, bolts, and screws are tight.

**14. Reconnect the negative battery cables!**

Thank you for purchasing the Airaid Intake System. Contact Airaid @ (800) 498-6951 8:00 AM - 5:00 PM MST weekdays for questions regarding fit or instructions that are not clear to you. Your Airaid Intake System was carefully inspected and packaged. Check that no parts are missing, or were damaged during shipping. If any parts are missing, contact Airaid. The air filter element is protected from direct exposure to water and debris; care should be taken not to drive through deep water. WATER INGESTION IS THE DRIVERS RESPONSIBILITY! The air filter is reusable and should be cleaned periodically.

**FILTER IDENTIFICATION**

700-469 Airaid Oiled Media  
702-469 Airaid SynthaMax Dry Media - Black

701-469 Airaid SynthaMax Dry Media - Red  
703-469 Airaid SynthaMax Dry Media - Blue

**For your Oiled media filter we suggest using the AIRAID Filter Tune-Up Kit!**

*SynthaMax*  
**Do Not Oil**



P/N 790-551 Aerosol Spray  
P/N 790-550 Squeeze Spray



Synthamax Air Filters do not require oil. Service air filter as needed by cleaning with common non-petroleum all-purpose household cleaner and water. Simple Green®, Formula 409® or equivalent works great. Apply cleaner to outside of air filter and allow to soak. Then flush filter clean from the inside out with a garden hose and repeat steps if necessary. Do not apply high pressure water or air to clean filter. Allow filter to air dry and reinstall.