



## Installation Instructions

For Part Numbers:

200-229	720-472 Airaid Oiled Media Filter
201-229	721-472 SynthaMax Dry Media Filter - Red
202-229	722-472 SynthaMax Dry Media Filter - Black
203-229	723-472 SynthaMax Dry Media Filter - Blue

**2004-05 Chevrolet Silverado 2500HD  
2005 Chevrolet Silverado 3500HD  
2004 GMC Sierra 2500HD/3500HD  
6.6L V8 Duramax Diesel "LLY"**

### Component Identification

1.	Airaid Premium Filter	1
2.	Airaid Intake Tube	1
3.	Cold Air Box	1
4.	Filter Adapter	1
5.	Urethane Hump Hose	1
6.	Urethane Coupler	1
7.	Weather Strip 25 1/2"	1
8.	1/4-20 x 1/2" Button Head	3
9.	1/4" Flat Washer	4
10.	8-32 x 1/2" Button Head	2
11.	#60 Hose Clamp	2
12.	#72 Hose Clamp	2
13.	Fender Bracket	1
14.	1/4-20 x 3/4" Hex Bolt	1
15.	1/4-20 Flange Nut	1
16.	T-20 Torx Bit	1

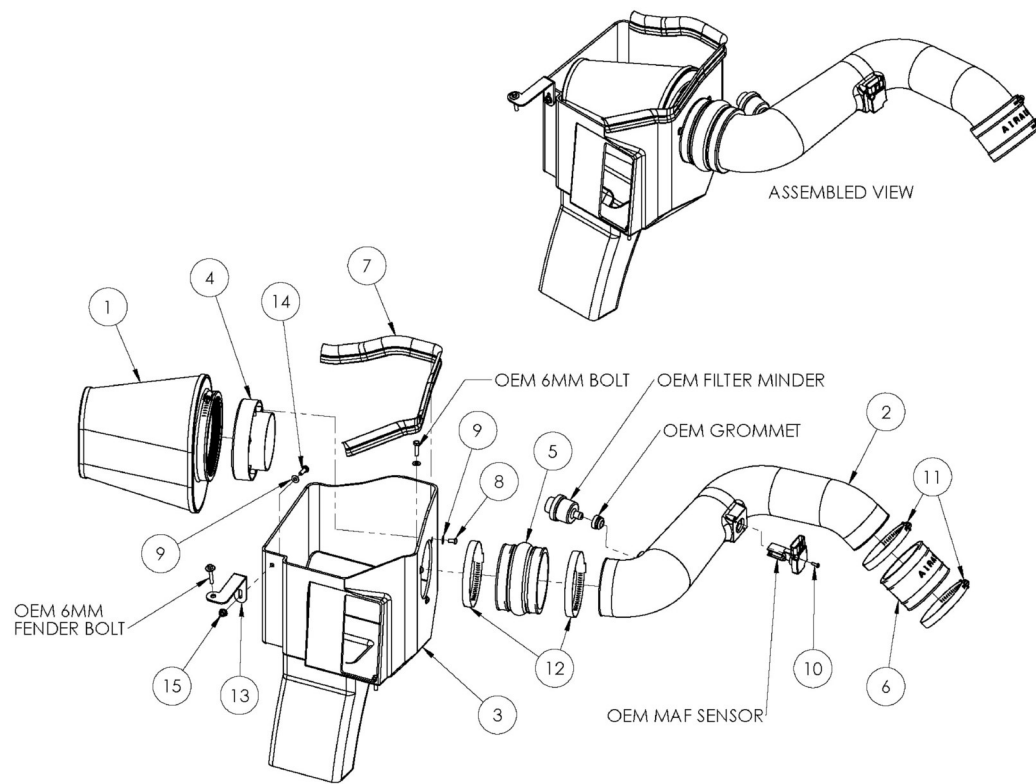

Full color instructions can be viewed on our web site at [Airaid.com](http://Airaid.com).



#### 1. Disconnect the negative battery cable.

Loosen the hose clamps on each end of the factory intake tube assembly and remove tube.

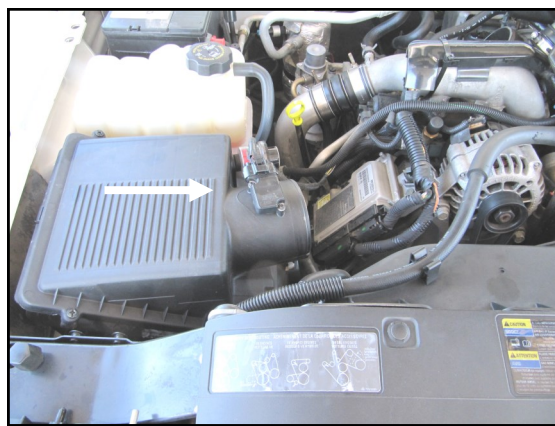

2. Disconnect the Mass Air Flow (M.A.F.) sensor and remove the factory airbox. Rock the factory air box back and forth and remove it from its mounting. It is held in place with grommets.

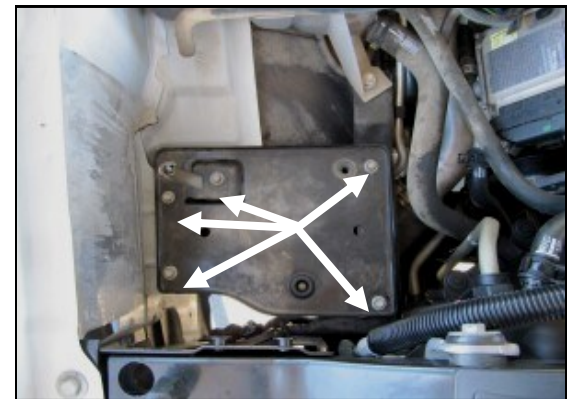

3. Using a 10mm socket, remove the five bolts and mounting plate from the engine compartment. Do not discard factory bolts. Three of them will be re used in step 5.

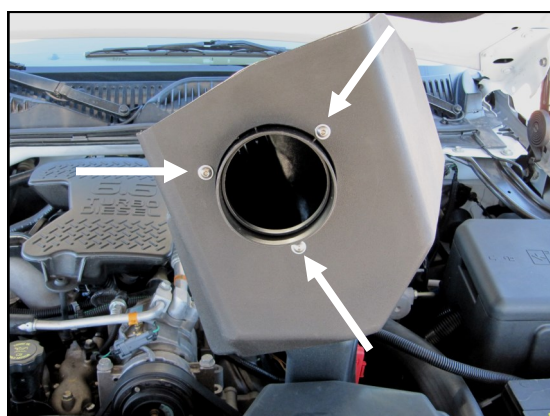

4. Install the Filter Adapter (#4) onto the Cold Air Box, or CAB (#3), as shown using the three 1/4-20 Button Head Bolts (#8) and 1/4" Washers (#9).



5. Install the Airaid Cold Air Box into the vehicle replacing the factory airbox. Secure the CAB using three of the bolts from step 3. Do not over tighten

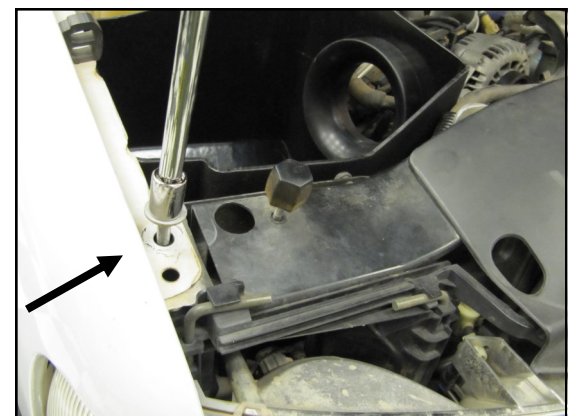

6. Using a 13mm socket, remove the factory fender bolt and set it aside. It will be reused in step 7.



7. Install the Fender bracket (#13) as shown. **A.)** Secure the bracket to the fender using the factory bolt. **B.)** Use the 1/4-20 x 3/4" hex bolt (#14), one 1/4" flat washer (#9), and the 1/4-20 flange nut (#15) to secure the CAB to the Bracket.



8. Transfer the M.A.F. Sensor from the factory airbox into the Airaid intake tube (#2). Use the two 8-32 button head screws (#10), to secure the meter.

**Do Not Use Factory Screws.**



9. Transfer the factory rubber grommet and air filter minder from the airbox top into the Airaid intake tube As shown.



11. Install the urethane hump hose (#5) and two #72 hose clamps (#12) onto the large end of the Airaid intake tube. (*Note: Leave hose clamps loose until final assembly.*)

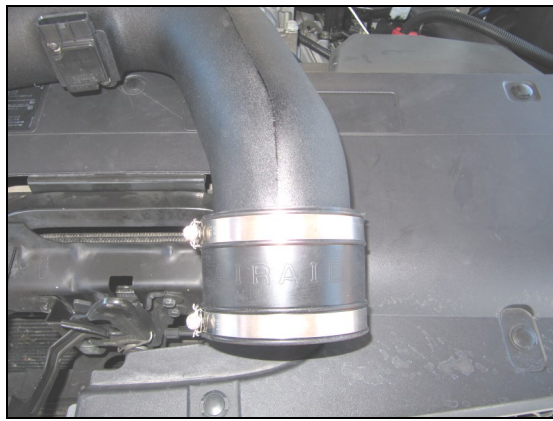

12. Install the urethane coupler (#6) and two #60 hose clamps (#11) onto the small end of the Airaid intake tube. (*Note: Leave hose clamps loose until final assembly.*)



13. Your complete Intake tube assembly should look like this.

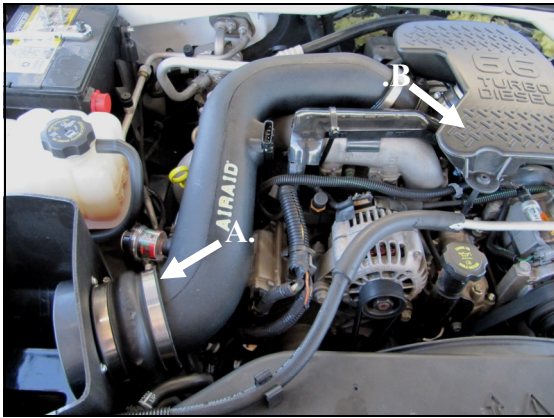

14. A.) Install the hump hose end of the Airaid intake tube assembly onto the filter adapter first. B.) Slip the coupler end of the tube over the factory turbocharger inlet. Adjust for fit, and tighten the hose clamps



15. Install the Airaid Premium Filter (#1) onto the filter adapter, and tighten the hose clamp. Install the weather strip (#7) onto the Airaid Cold Air Box. Reconnect the M.A.F. sensor. Apply the Airaid Decal inside of the Airbox as shown.

**16. Double check your work!**  
Make sure there is no foreign material in the intake path. Make sure all clamps, hoses, bolts, and screws are tight.

**16. Reconnect the negative battery cable!**



**WARNING!** If your vehicle has a Vehicle Emission Control Information decal affixed to the factory airbox, a new replacement label must be obtained and installed in a readily visible position in the engine compartment in order to remain CARB compliant. Failure to do so will prevent the vehicle from passing a smog check. Replacement labels can be ordered from your local dealership. Regulations state that the VECI label shall not be affixed to any equipment which is easily detached from the vehicle. Label placement, under the hood on a painted surface is recommended.

Thank you for purchasing the Airaid Intake System. Contact Airaid @ (800) 498-6951 8:00 AM - 5:00 PM MST weekdays for questions regarding fit or instructions that are not clear to you. Your Airaid Intake System was carefully inspected and packaged. Check that no parts are missing, or were damaged during shipping. If any parts are missing, contact Airaid. The air filter element is protected from direct exposure to water and debris; care should be taken not to drive through deep water. WATER INGESTION IS THE DRIVERS RESPONSIBILITY! The air filter is reusable and should be cleaned periodically.

## FILTER IDENTIFICATION

720-472 Airaid Oiled Media  
722-472 Airaid SynthaMax Dry Media - Black

721-472 Airaid SynthaMax Dry Media - Red  
723-472 Airaid SynthaMax Dry Media - Blue

**For your Oiled media filter  
we suggest using the AIRAID  
Filter Tune-Up Kit!**



P/N 790-551 Aerosol Spray  
P/N 790-550 Squeeze Spray



*SynthaMax*<sup>®</sup>

**Do Not Oil**

Synthamax Air Filters do not require oil. Service air filter as needed by cleaning with common non-petroleum all-purpose household cleaner and water. Simple Green®, Formula 409® or equivalent works great. Apply cleaner to outside of air filter and allow to soak. Then flush filter clean from the inside out with a garden hose and repeat steps if necessary. Do not apply high pressure water or air to clean filter. Allow filter to air dry and reinstall.