



Installation Instructions

For Part Numbers:

- | | |
|---------|--|
| 200-271 | 720-472 Airaid Oiled Media Filter |
| 201-271 | 721-472 SynthaMax Dry Media Filter - Red |
| 202-271 | 722-472 SynthaMax Dry Media Filter - Black |

2009-10 Chevrolet Silverado 2500HD/3500HD/Suburban 2500
 2009-10 GMC Sierra 2500HD/3500HD/Yukon XL 2500
 6.0L V8 *With Mechanical Cooling Fan*

CARB exemption does not apply to certified SULEV vehicles

INTAKE SYSTEMS FOR VEHICLES LISTED ARE 50 STATE LEGAL. SEE AIRAID.COM FOR CARB STATUS ON EACH PART FOR A SPECIFIC VEHICLE.

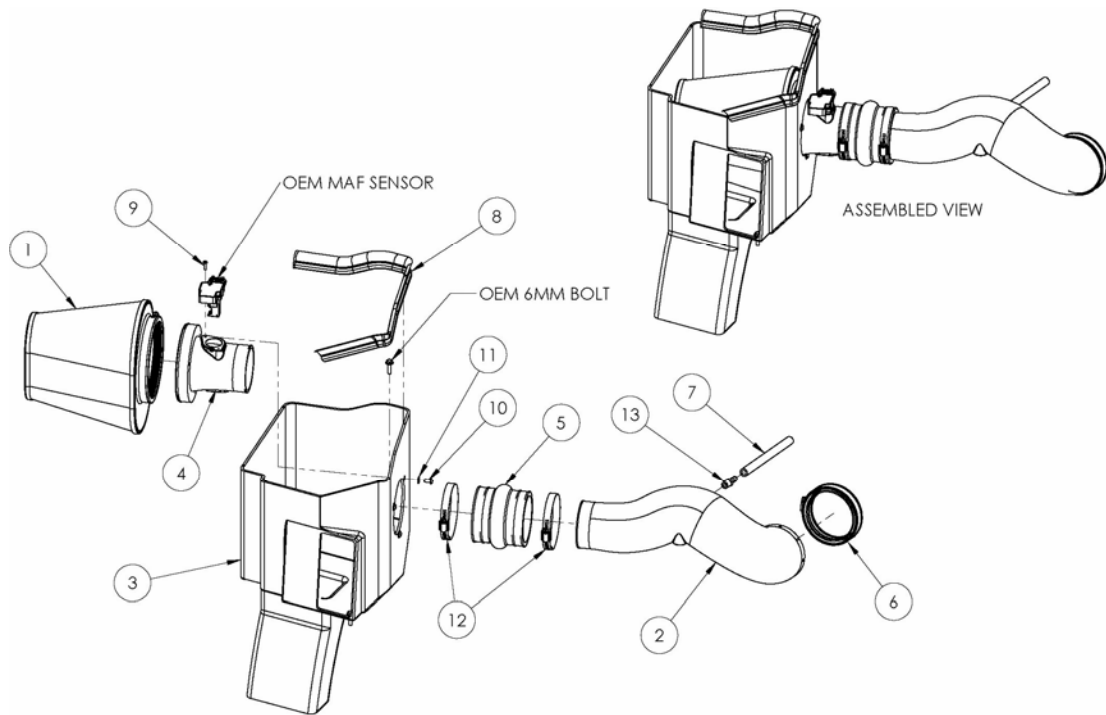

Component Identification

1.	Airaid Premium Filter	1
2.	Airaid Intake Tube	1
3.	Cold Air Box	1
4.	Filter Adapter	1
5.	Urethane Hump Hose	1
6.	Coupler w/ #68 Clamp	1
7.	3/8" x 8" Breather Hose	1
8.	Weather Strip 25"	1
9.	8-32 x 1/2" Button Head Screw	2
10.	1/4-20 x 1/2" Button Head Screw	3
11.	1/4" Flat Washer	3
12.	#64 Hose Clamp	2
13.	1/4 NPT x 3/8 Barbed Fitting	1
14.	Edge Clip Cable Tie	1
15.	Airaid Decal	1

Full color instructions can be viewed on our web site at Airaid.com. If you need any assistance please call 1-800-858-3333 to speak with a representative in our Customer Service Center before returning the product.

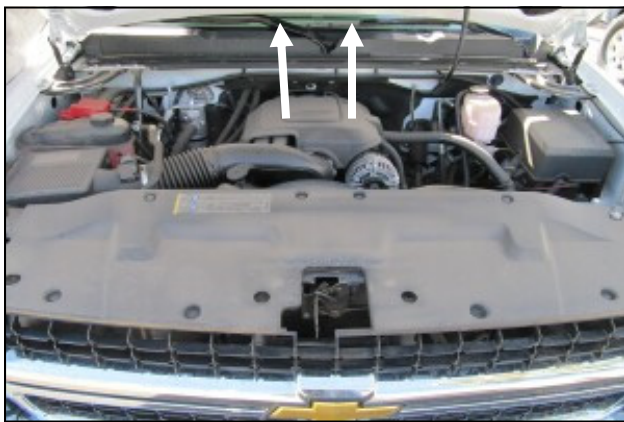

1. Disconnect the negative battery cable. Remove the engine cover by simply pulling up on it and sliding out from the vehicle.



2. Pull the PCV breather line from the factory intake tube.

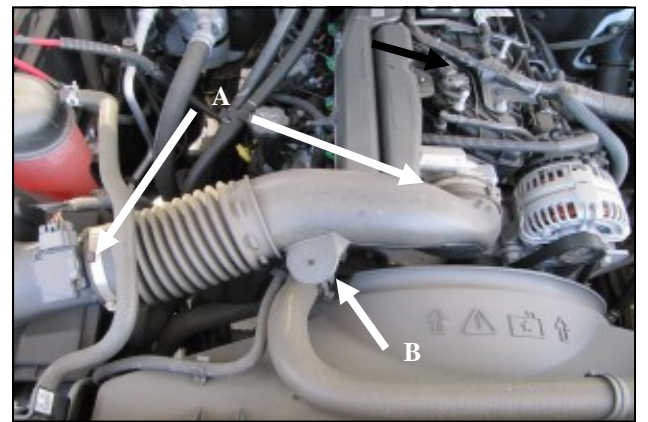

3.A.) Loosen the clamps securing the factory intake tube to the throttlebody and the airbox.
B.) Separate the hose anchor from the factory intake and remove the factory tube.



4. Remove the plastic PCV breather line from the factory hard line. A standard screwdriver works well for depressing the locking tab in the coupling.



5. Disconnect the Mass Air Flow or MAF sensor and remove the factory airbox from the vehicle. The airbox is secured to the vehicle with grommets and simply lifts out.

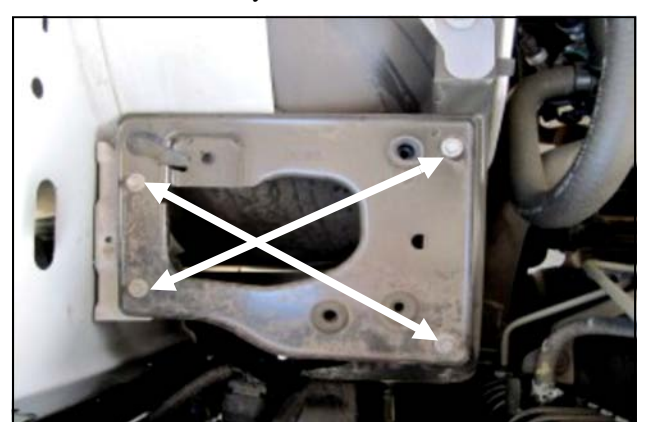

6. Remove the four tray bolts and the airbox mounting tray. Three of the bolts will be reused in step 9.



7. Secure the wiring harness to the inner fender as shown using the Edge Clip Cable Tie (#14).

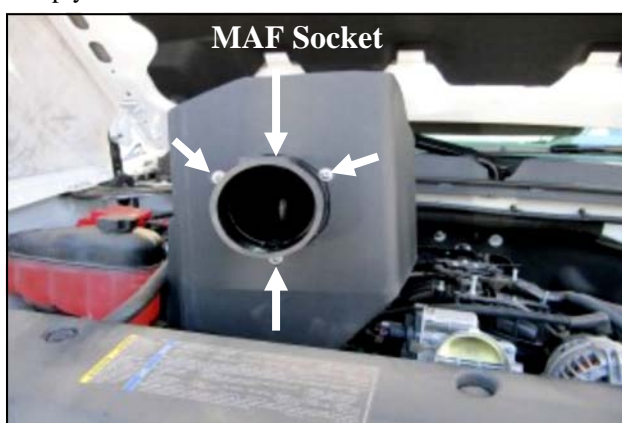

8. Install the Filter Adapter (#4) onto the Cold Air Box or CAB (#3) as shown using the three 1/4-20 Button Head Screws (#10) and 1/4" Flat Washers (#11). Note: The MAF socket is to be in the 12:00 position when properly assembled.



9. Install the CAB (#3) into the engine compartment and secure using three of the tray bolts from step 6. Apply the Airaid Foil Decal onto the Panel as shown.



10. Transfer the Mass Air Flow sensor from the factory airbox into the Filter Adapter. Secure the sensor using the 8-32 Button Head Screws (#9).

Do Not Use Factory Hardware !

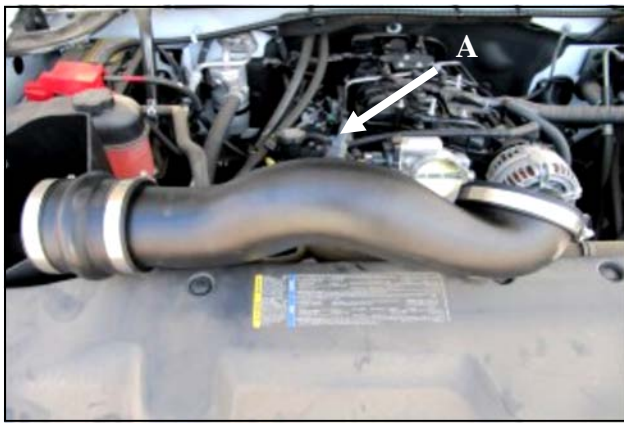

11. A.) Install the 3/8 NPT Fitting (#13) into the Airaid Intake Tube.

B.) Install the Hump Hose (#5), Coupler (#6) and Hose Clamps (#12) on to the Intake tube as shown. Leave Clamps loose for now.

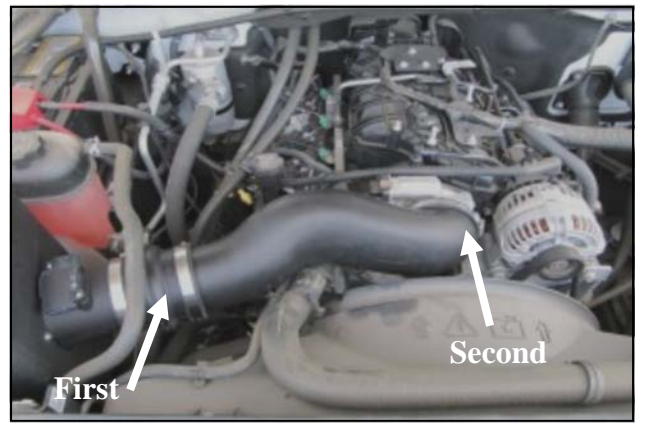

12. Install the Airaid Intake Tube assembly onto the Filter Adapter first, and then onto the throttlebody. Adjust for fit, and tighten all hose clamps. Reinstall the hose anchor into the Airaid Intake Tube.

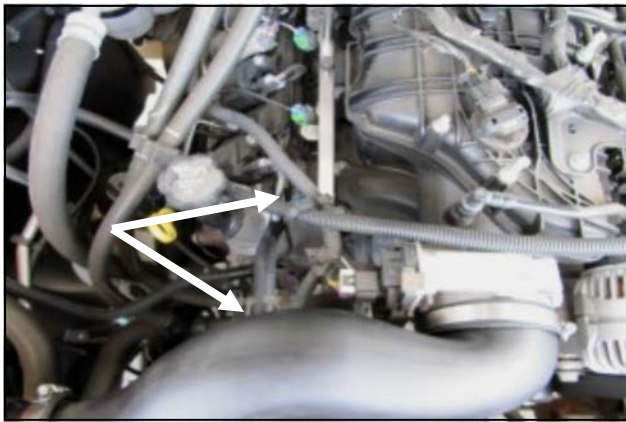

13. A) Install the 3/8" Breather Hose (#7) onto the Barbed Fitting and factory hard line.



14. Install the Airaid Premium filter (#1) onto the Filter Adapter, and tighten the hose clamp. Install the Weather Strip (#8) onto the Airaid Cold Air Box. Reconnect the M.A.F. sensor. (*Hint: Start from one corner and work your way around for ease of install.*)



15. Reinstall the engine cover.

Double check your work!

Make sure there is no foreign material in the intake path. Make sure all clamps, hoses, bolts, and screws are tight. Double check the hood clearance.

Reconnect the negative battery cable!



WARNING! If your vehicle has a Vehicle Emission Control Information decal affixed to the factory airbox, a new replacement label must be obtained and installed in a readily visible position in the engine compartment in order to remain CARB compliant. Failure to do so will prevent the vehicle from passing a smog check. Replacement labels can be ordered from your local dealership. Regulations state that the VECI label shall not be affixed to any equipment which is easily detached from the vehicle. Label placement, under the hood on a painted surface is recommended.

Thank you for purchasing the Airaid Intake System. Contact Airaid @ (800) 498-6951 8:00 AM - 5:00 PM MST weekdays for questions regarding fit or instructions that are not clear to you. Your Airaid Intake System was carefully inspected and packaged. Check that no parts are missing, or were damaged during shipping. If any parts are missing, contact Airaid. The air filter element is protected from direct exposure to water and debris; care should be taken not to drive through deep water. WATER INGESTION IS THE DRIVERS RESPONSIBILITY! The air filter is reusable and should be cleaned periodically.

FILTER IDENTIFICATION

720-472 Airaid Oiled Media

721-472 Airaid SynthaMax Dry Media - Red

722-472 Airaid SynthaMax Dry Media - Black

For your Oiled media filter we suggest using the AIRAID Filter Tune-Up Kit!



P/N 790-551 Aerosol Spray
P/N 790-550 Squeeze Spray



INTAKE SYSTEMS FOR VEHICLES LISTED ARE 50 STATE LEGAL. SEE AIRAID.COM FOR CARB STATUS ON EACH PART FOR A SPECIFIC VEHICLE.



Do Not Oil

Synthamax Air Filters do not require oil. Service air filter as needed by cleaning with common non-petroleum all-purpose household cleaner and water. Simple Green®, Formula 409® or equivalent works great. Apply cleaner to outside of air filter and allow to soak. Then flush filter clean from the inside out with a garden hose and repeat steps if necessary. Do not apply high pressure water or air to clean filter. Allow filter to air dry and reinstall.

AIR-I20271B

REV.07.01.16