

2004-2015 Nissan Titan King Cab & Crew Cab Underseat Storage

Fits DU-HA Part Numbers
40010
40011
40057

Installation Instructions:

- 1 Flip up the bottoms of the back seats.
- 2 Thread nylon straps through the seat belt loops under the back seats, by sliding straps through the backside of seat belt loops, so the buckles end up on top.
- 3 Place the DU-HA under the back seats with the high side forward.
- 4 Thread nylon straps through the slots in the back of the DU-HA.
- 5 Loop each strap together by threading up through the bottom of the back slot of the buckle and down through the front slot of the buckle. Tighten as pictured. The nylon straps help secure the DU-HA in the truck.
- 6 Install the dividers in the DU-HA by sliding them into the channel slots in the DU-HA. Install the foam organizer/gun racks with the plastic stiffeners by sliding them into the pre-cut slots in the dividers (as pictured below).

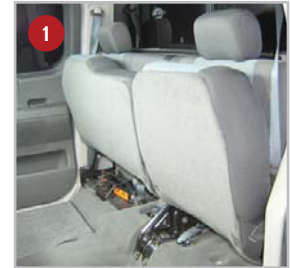

Ribs on buckle should face up. Thread strap through buckle as shown.



This is how the DU-HA should look installed under the back seat.

Safety Instructions:

Warning: Seat must be down and latched at all times while vehicle is moving. Make sure DU-HA is secured according to the installation instructions. Do not store explosives or hazardous materials in the DU-HA. Do not place loaded guns in the DU-HA.

For further instructions refer to truck owners manual or contact DU-HA, Inc.

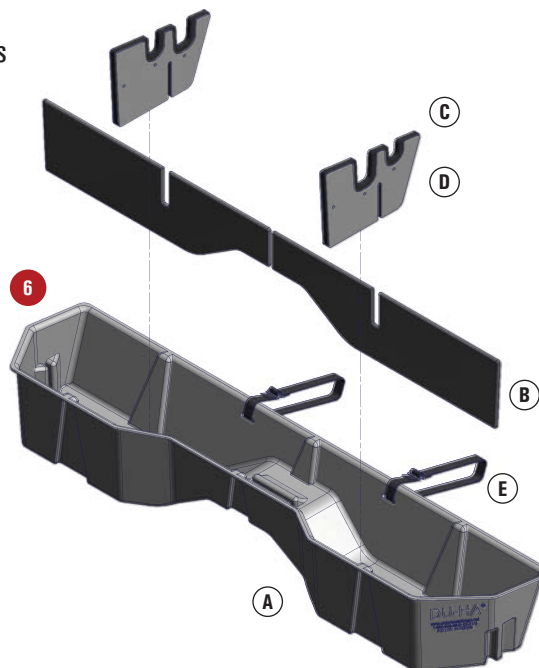

Part	Description	Qty
A	DU-HA Storage Unit	1
B	Divider	2
C	Foam Organizer / Gun Rack	2
D	Plastic Stiffener	4
E	Nylon Strap with Buckle	2