



Installation Instructions

BR5 Front Bumper Replacement Part Number 24128T

2013-2016 Ram 1500 2/4WD (Excludes Rebel Models)

Do not attempt to install this product on any vehicle other than the one listed above!

Parts List

Item	Qty.	Part #	Description	Item	Qty.	Part #	Description	Torque
1	1		Bumper Replacement Shell	19	1		License Plate Bracket	
2	1		Mounting Plate/Winch Tray	20	4		Bumper Shell Hole Plug (large)	
3	1		Passenger Frame Bracket	21	4		Bumper Shell Hole Plug (small)	
4	1		Driver Frame Bracket	22	2		Vent Cover Hole Plug	
5	2		Frame Bracket Extension	23	38		1/4" x 3/4" Button Head Bolt	71 In. lbs.
6	1		Passenger Auxiliary Bracket	24	10		1/4" Nylon Lock Nut	
7	1		Passenger Auxiliary Bracket Extension	25	6		3/8" x 1 1/4" Hex Bolt	26 ft. lbs.
8	1		Driver Auxiliary Bracket	26	2		3/8" x 5" Hex Bolt	
9	1		Driver Auxiliary Bracket Extension	27	8		3/8" Lock Washer	
10	1		Passenger Support Bracket	28	14		3/8" Flat Washer	
11	1		Driver Support Bracket	29	8		3/8" Hex Nut	
12	2		Support Bracket Extension	30	2		M12-1.50 x 40mm Hex Bolt	55 ft. lbs.
13	1 Pr.		Sensor Plate (outer sensor)	31	8		1/2" x 1 1/2" Hex Bolt	64 ft. lbs.
14	1		Passenger Vent Cover (middle sensor)	32	18		1/2" x 1 1/2" Carriage Bolt	64 ft. lbs.
15	1 Pr.		Sensor Plate (inner sensor)	33	30		1/2" Flat Washer	
16	1		Driver Vent Cover (middle sensor)	34	28		1/2" Lock Washer	
17	1		Winch Cover	35	20		1/2" Hex Nut	
18	2		Light Pod Plate					

ILLUSTRATION #1

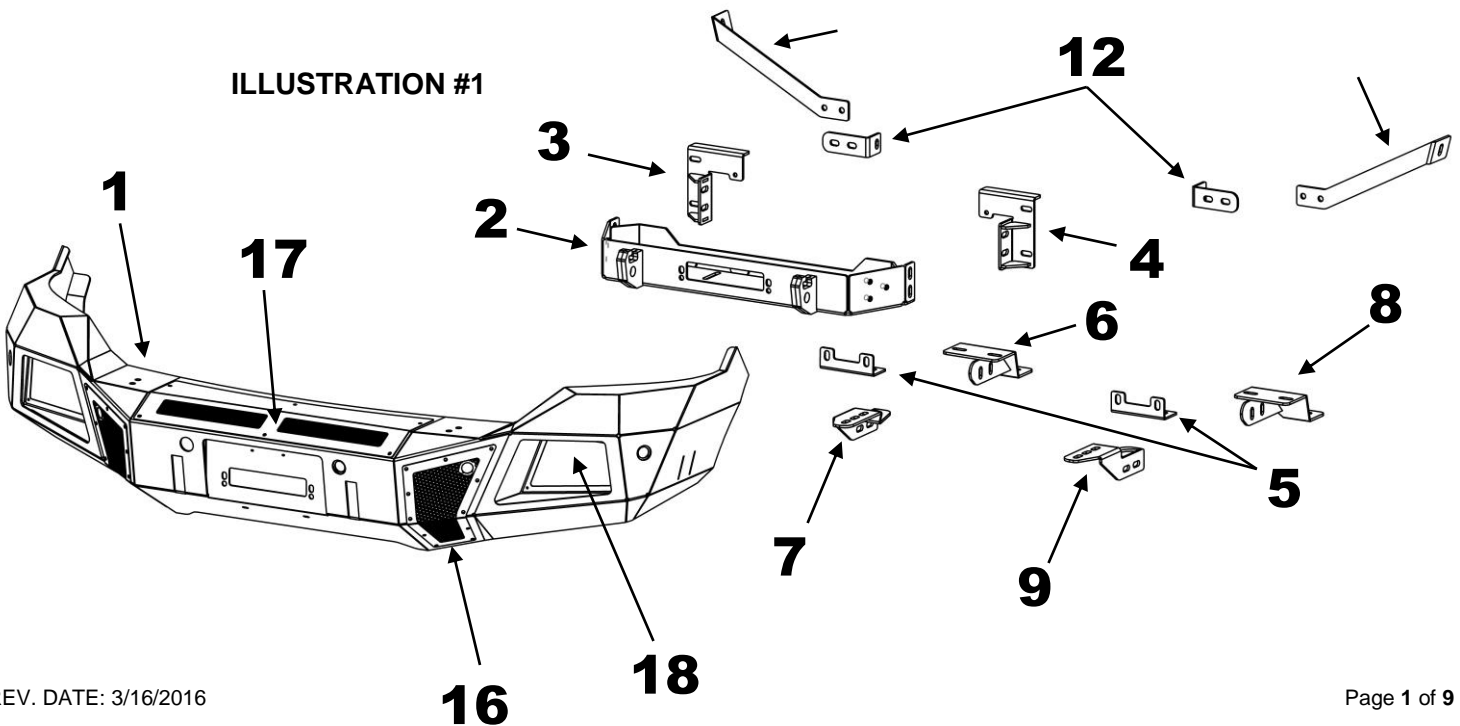

Tools Required: 3/8" & 1/2" Drive Sockets / 8mm, 10mm, 13mm, 15mm, 18mm, 7/16", 9/16" & 3/4"
Wrenches / 8mm, 10mm, 13mm, 15mm, 18mm, 7/16", 9/16" & 3/4"
Slotted Blade Screw Driver
5/32" Hex Key
3/8" & 1/2" Drive Ratchet, Ratchet Extensions & Swivel Joint Adapter **Approximate installation time: 2 hrs.**

IMPORTANT INSTALLATION NOTES AND SUGGESTIONS

The pre-installed Mesh Winch and Vent Covers need to be removed using hand tools to slowly remove the bolts. Using an air assisted impact or ratchet will damage the bolt threads and the internal nut assembly in the bumper shell. Use of an appropriate anti-seize compound is highly recommended for re-installation, and tighten the bolts to the specified torque as overtightening could result in difficulty of future removal.

If you are replacing a bumper with front Park Assist, the sensor detection zone will be altered with use of this bumper replacement.

To maintain and care this product keep it clean and do not use abrasive cleaners or polish waxes.

Texture Painted Finish: Mild liquid detergent may be used. **Polished Stainless & Semi-Gloss Painted Finishes:** We recommend using only non-abrasive automotive wax such as pure carnauba to avoid scratches and rust.

Read the installation instructions completely and verify that all of the parts listed are accounted for. If you have defective, missing or damaged parts or need assistance, please contact Go Rhino Products for fast, friendly customer service at: (888) 427-4466 or email: sales@gorhino.com

Factory Bumper Removal

Step-1 Open hood and disconnect the vehicle battery or batteries.

Step-2 Remove the (6) plastic tree clips securing the radiator cover to the radiator support. Using a flat blade screw driver, pull the head of the tree clip up, remove the tree clips and lift radiator dust cover off. This will allow access to the bolts securing the top of the grille, (Photo 1).

Step-3 Remove the (4) screws securing the top of the grille to the radiator support, (Photo 2). Unsnap the pins located behind the grille on each side midway and bottom, and then remove the grille from the vehicle.

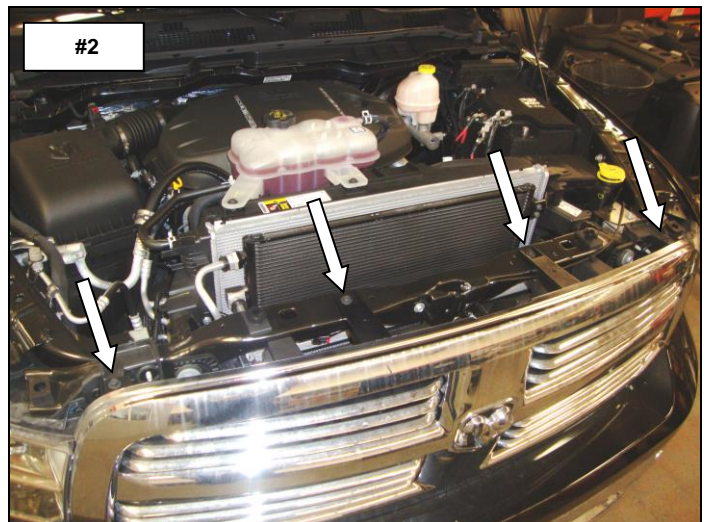
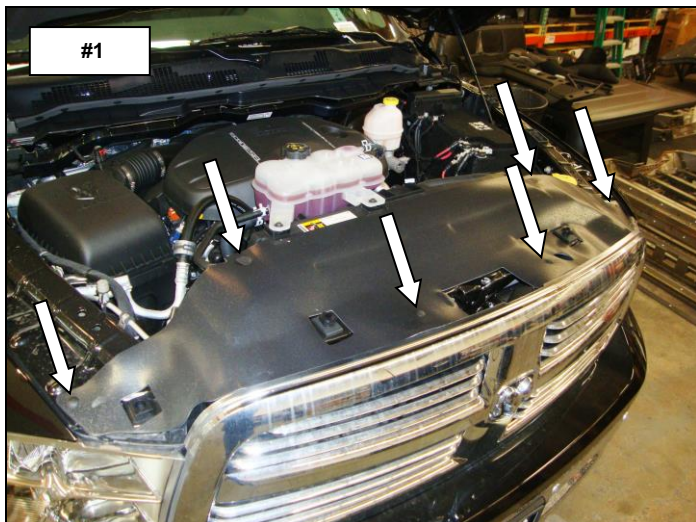

Step-4 On each side of the vehicle, remove (2) screws securing the fender liner and bumper valance, (Photo 3). Pull the fender liner back for access and remove the bolt securing the bumper valance to the fender, (Photo 4).

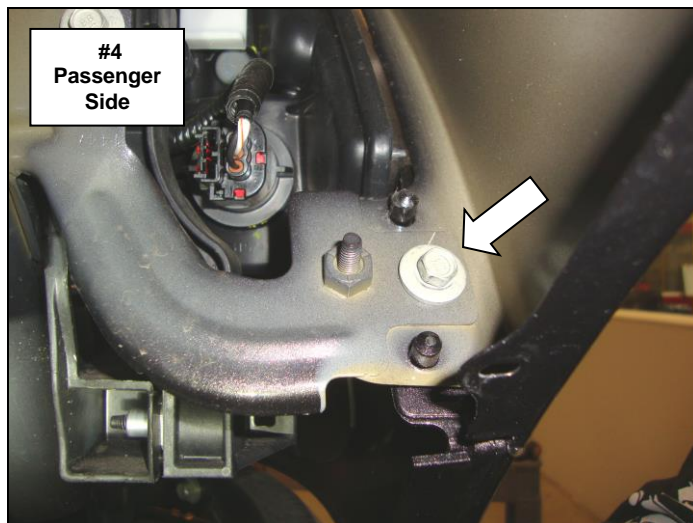
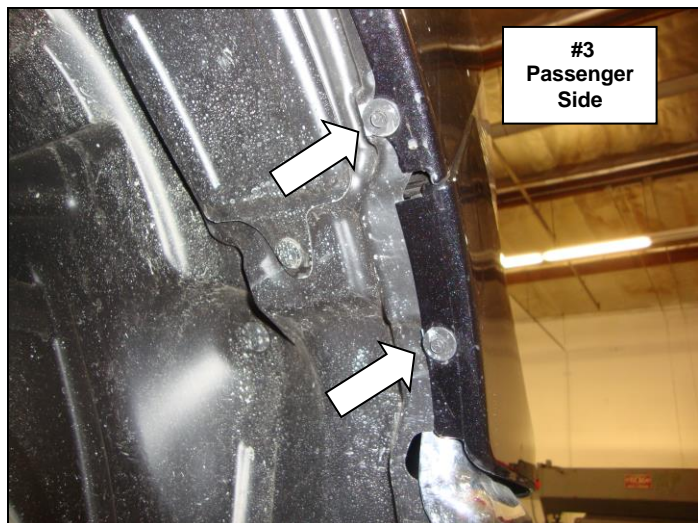

Step-5 Working from side to side pull outward on the valance to unsnap the clips and remove the valance from the vehicle.

Step-6 On each side of the vehicle, remove (3) screws securing bumper valance corner support bracket, (Photo 5). Remove the valance corner support bracket from the vehicle.

Step-7 On each side of the vehicle, remove (2) bolts securing the bumper valance center support bracket, (Photo 6). Remove the valance center support bracket from the vehicle.

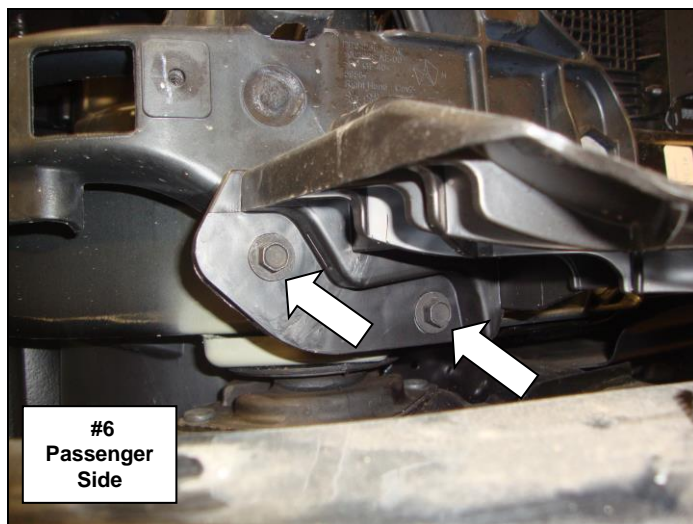
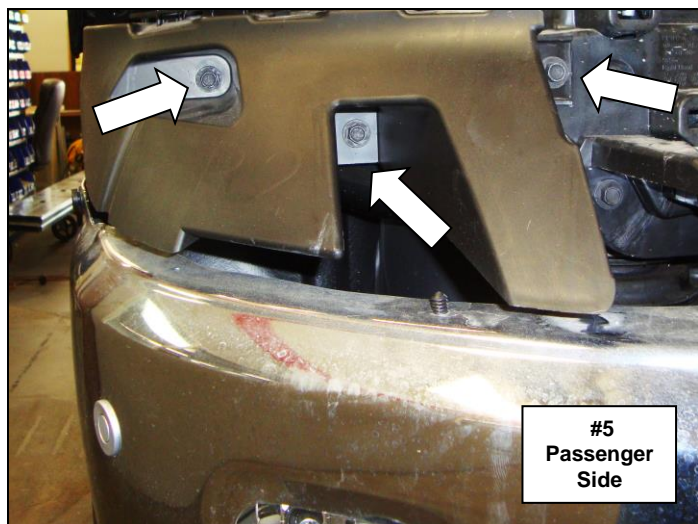

Step-8 If equipped, disconnect the Fog light and Part Assist bumper wiring harnesses from the vehicle wiring harnesses.

Step-9 Support the factory bumper, and on each side of the vehicle, remove the (3) nuts securing the bumper connector bracket to the flange on the end of the frame rail, (Photo 7). With assistance remove the bumper from the vehicle, (Photo 8).

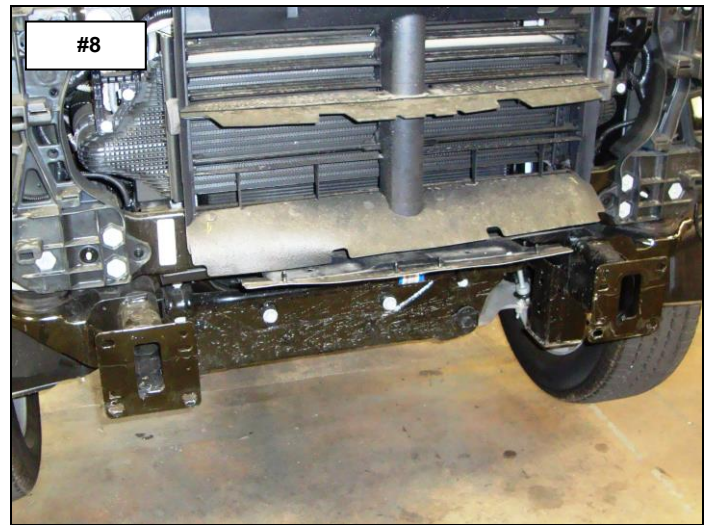
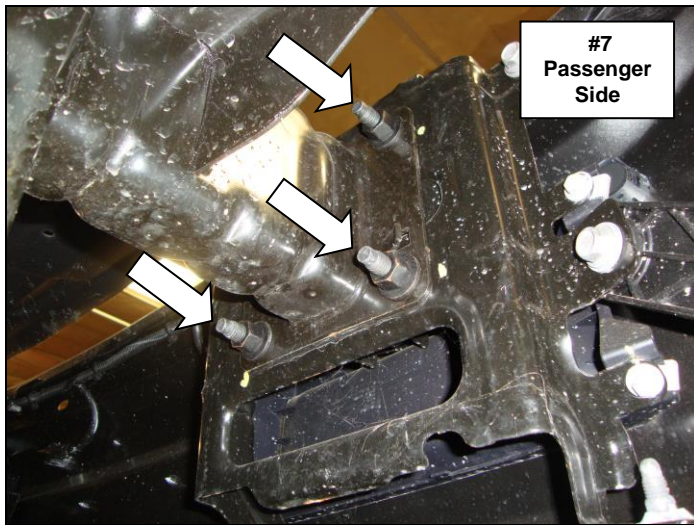

Step-10 Reinstall the factory grille and radiator dust cover.

BR5 Bumper Replacement Installation

Note: If your vehicle is not equipped with front Park Assist install the supplied plastic plugs in the holes in the replacement bumper and vent covers and proceed to step 9.

Note: If you are replacing a bumper with front Park Assist, the sensor detection zone will be altered with use of this bumper replacement.

Step-1 If the vehicle is equipped with front Park Assist, disconnect the sensors from the factory bumper wiring harness and remove the sensor wiring harness from the bumper.

Step-2 Remove each sensor from the plastic bezel by gently spreading the bezel tabs and pulling out on the back of the sensor. Note: Do not push on the front of the sensor as this may damage the sensor.

Step 3 Remove the sensor bezels from the factory bumper by depressing the tabs around the base and pushing the bezel out through the front of the bumper. Note: The sensors and bezels have to be positioned in the replacement bumper in the same location (inner, middle and outer), (driver and passenger) as removed from the factory bumper.

Step-4 Install the inner and outer sensor bezels and sensors in the supplied bezel plates, (Illustration 1). From the side with applied tape, line up the protrusions on the bezel with the profile in the bezel plate; push the bezel through the profile in the plate until the tabs around the base lock in position, then install the sensor in the bezel. Note: The U notches in the sensor plates designate the top, and the V notches on the side position toward the center of the vehicle.

ILLUSTRATION 2

Step-5 Install the middle sensor bezels and sensors in the passenger and driver vent covers, (Illustration 1). Line up the protrusions on the bezel with the profile in the vent cover; push the bezel through the profile in the vent cover until the tabs around the base lock in position, then install the sensor in the bezel. **Do not install the vent cover at this time.**

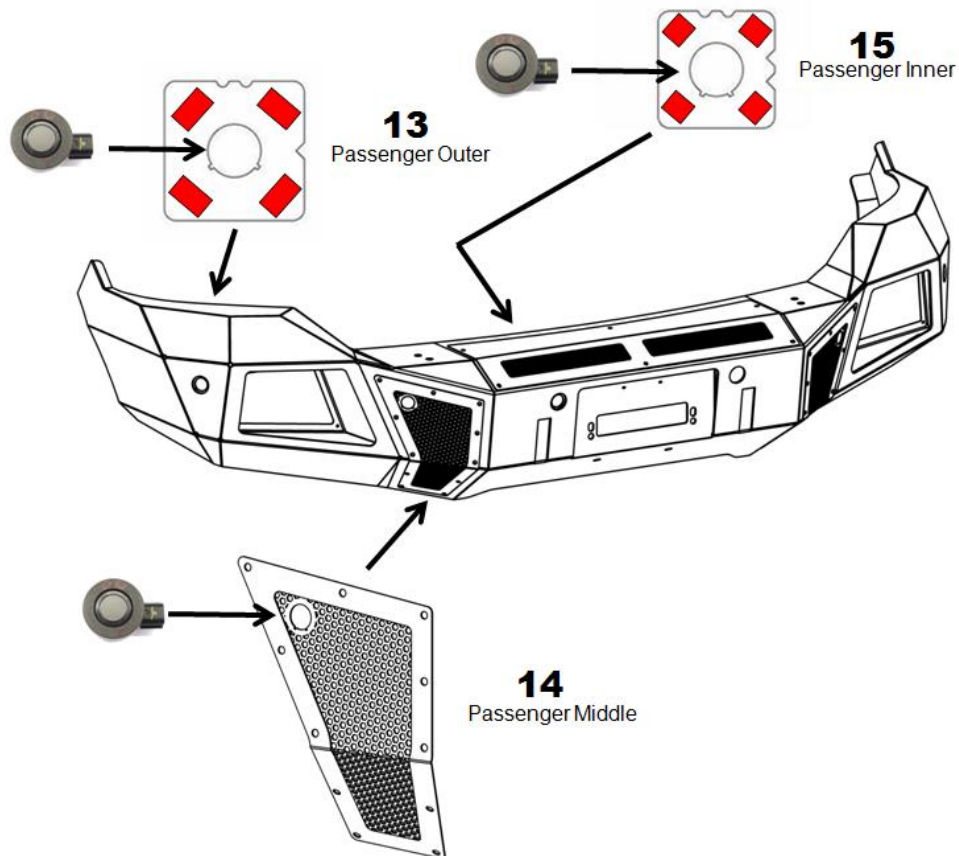

Step-6 Prepare the inside of the replacement bumper surface where the inner bezel plates will be mounted with Isopropyl alcohol. A clean, dry surface is required in order for tape to stick properly.

Step-7 Peel the backing off from the double sided tape to uncover the adhesive. From inside the replacement bumper position each bezel, sensor and bezel plate assembly, making sure the sensor bezel is centered in the hole provided in the replacement bumper.

Step-8 Stick the assembly in place and apply firm pressure for about 30 seconds. The tape needs to bond with the mounting surface, and it needs pressure to do this. The bezel mounting plate will seem like it is stuck on, but continue pressing for at least 30 seconds. Note: At room temperature approximately 50% of ultimate bond strength will be achieved after 20 minutes, 90% after 24 hours and 100% after 72 hours.

Step-9 Position the bumper replacement passenger side frame bracket up to flange on the end of the frame, align the (2) holes in the top of the frame bracket with the holes in the flange and secure the frame bracket to the outer side of the flange using (1) 1/2" x 1 1/2" carriage bolt, (1) 1/2" flat washer, (1) 1/2" lock washer and (1) 1/2" hex nut, and to the inner side using (1) 3/8" x 1 1/4" hex bolt, (2) 3/8" flat washers, (1) 3/8" lock washer and (1) 3/8" hex nut, (Photo 1). Leave the nuts and bolts loose for final adjustment.

Step-10 Position one of the bumper replacement frame bracket extensions behind the frame flange and secure the frame bracket extension to the frame flange and bumper replacement frame bracket using (2) 1/2" x 1 1/2" carriage bolts, (2) 1/2" flat washers, (2) 1/2" lock washers and (2) 1/2" hex nuts, (Photo 2). Leave the nuts and bolts loose for final adjustment.

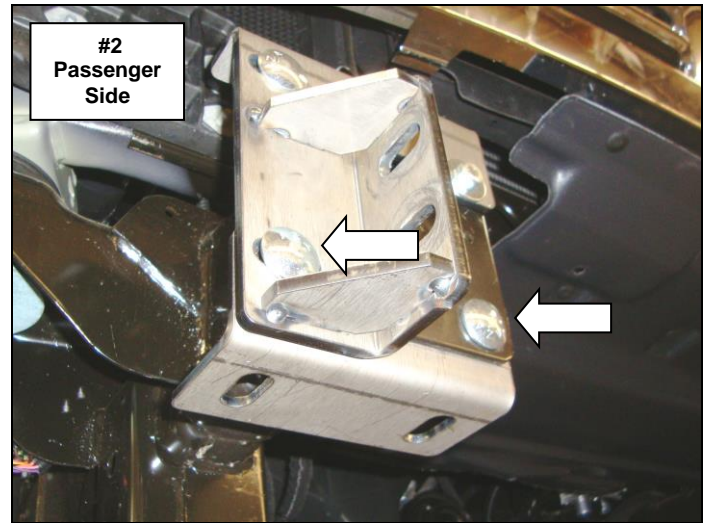
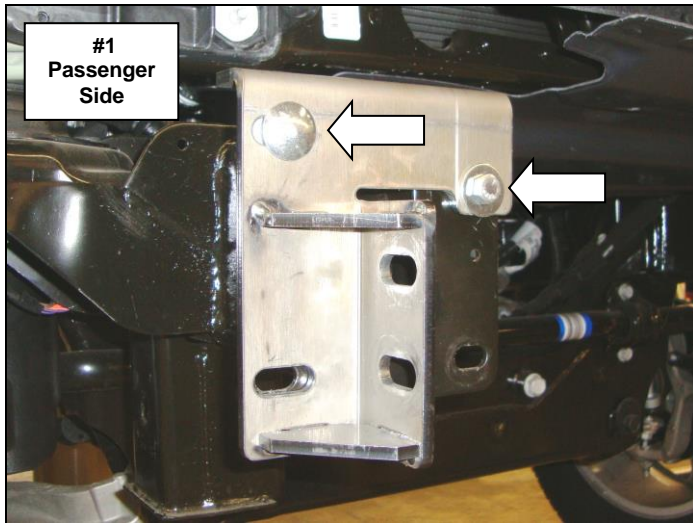

Step-11 Position the bumper replacement passenger side auxiliary bracket on the bottom of the frame extension bracket and the tow hook frame stanchion. Secure the auxiliary bracket to the frame extension bracket using (2) 1/2" x 1 1/2" carriage bolts, (2) 1/2" flat washers, (2) 1/2" lock washers and (2) 1/2" hex nuts and to the tow hook frame stanchion using (1) M12 x 40mm hex bolt, (1) 1/2" flat washer and (1) 1/2" lock washer, (Photo 3). Leave the nuts and bolts loose for final adjustment.

Step-12 Position the driver side auxiliary extension bracket on the inside of the auxiliary bracket, align the holes in the brackets and secure the extension bracket to the auxiliary bracket using (2) 1/2" carriage bolts, (2) 1/2" flat washers, (2) 1/2" lock washers and (2) 1/2" hex nuts, (Photo 4). Leave the nuts and bolts loose for final adjustment. Repeat steps 1 through 4 to install the driver side frame and auxiliary brackets.

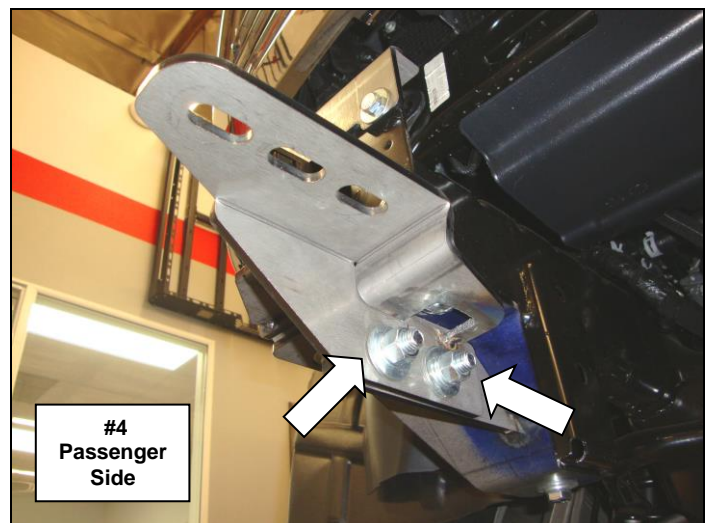
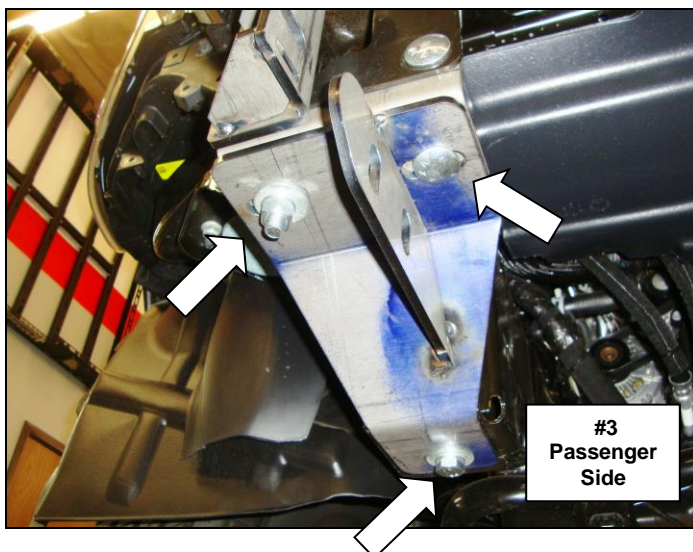

Step-13 Place the mounting plate/winch tray on top of the auxiliary brackets. Align the holes and secure the mounting plate/winch tray to each frame bracket using (2) ½" x 1 ½" carriage bolts, (2) ½" flat washers, (2) ½" lock washers and (2) ½" hex nuts, and to each auxiliary bracket using (3) ½" x 1 ½" carriage bolts, (3) ½" flat washers, (3) ½" lock washers and (3) ½" hex nut, (Photo 5 & 6).

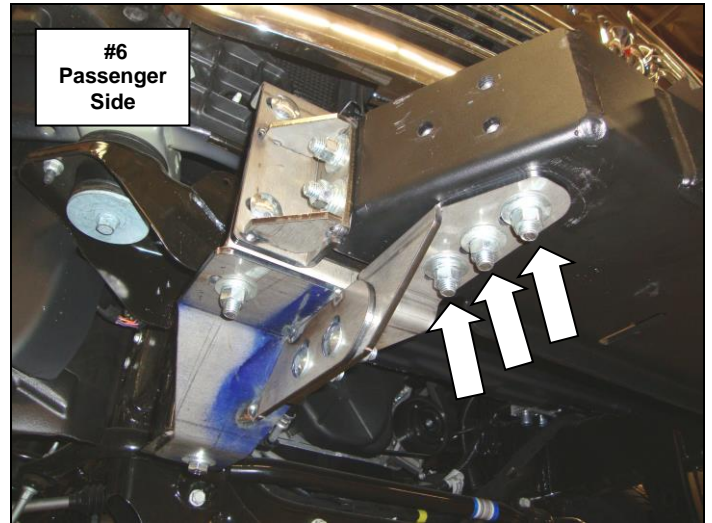
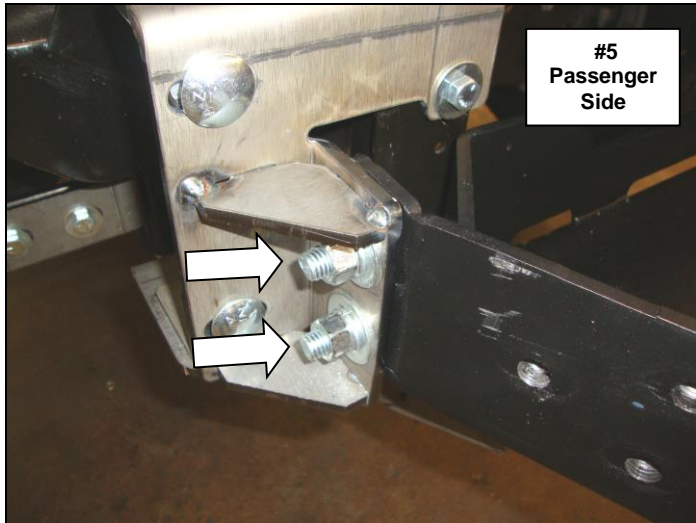

Step-14 Position the front edge of the mounting plate/winch tray 8 5/8" forward from the face of the frame bracket, (Photo 7). Center and level the mounting plate/winch tray with the vehicle then tighten the nuts and bolts securing the passenger and driver side frame brackets, and the nuts and bolts securing the mounting plate/winch tray to the frame brackets, (Photo 8). Do not tighten the auxiliary bracket nuts and bolts at this time.

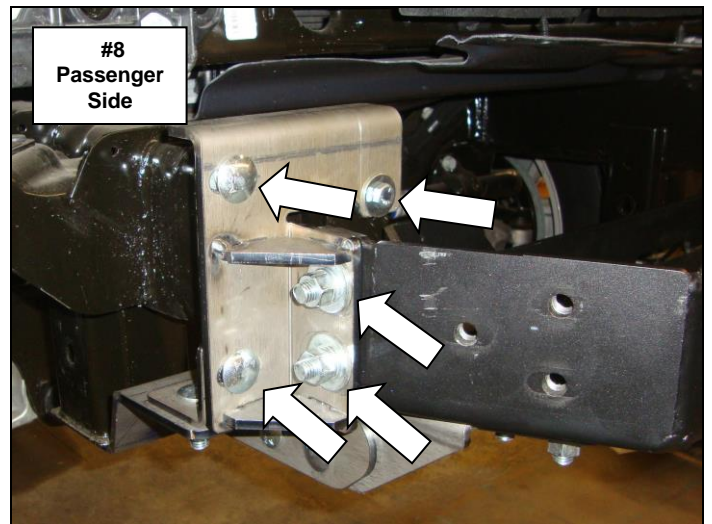
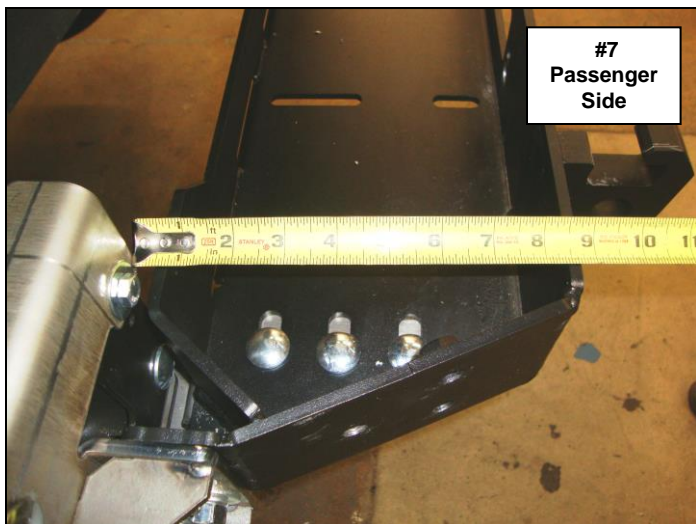

If you are installing a winch, place the winch in the winch tray and refer to the winch manufacturer's instructions for installation. Do not install the fairlead at this time.

Step-15 Assemble the passenger side support bracket and one of the support bracket extensions using (2) 3/8" x 1 1/4" hex bolts (4) 3/8" flat washers (2) 3/8" lock washers and (2) 3/8" hex nuts. Sung but do not fully tighten the bolts. Install a 3/8" flat washer on one of the 3/8" x 5" hex bolts and position the bolt through the lower set of holes in the tow hook frame stanchion with the threads protruding toward the outside of the vehicle. Secure the support bracket assembly to the side of the tow hook frame stanchion using the 3/8" x 5" hex bolt (1) 3/8" flat washer, (1) 3/8" lock washer and (1) 3/8" hex nut, (Photo 9). Repeat this step to assembly and install the driver side support brackets.

Step-16 With assistance lift the bumper shell up to the vehicle, align the holes in the bumper shell brackets with the weld nuts on the mounting plate/winch tray and secure the bumper shell to each side of the mounting plate/winch tray using (3) 1/2" x 1 1/2" hex bolts, (3) 1/2" lock washers and (3) 1/2" flat washers, (Photo 10). Leave the bolts loose for final adjustment.

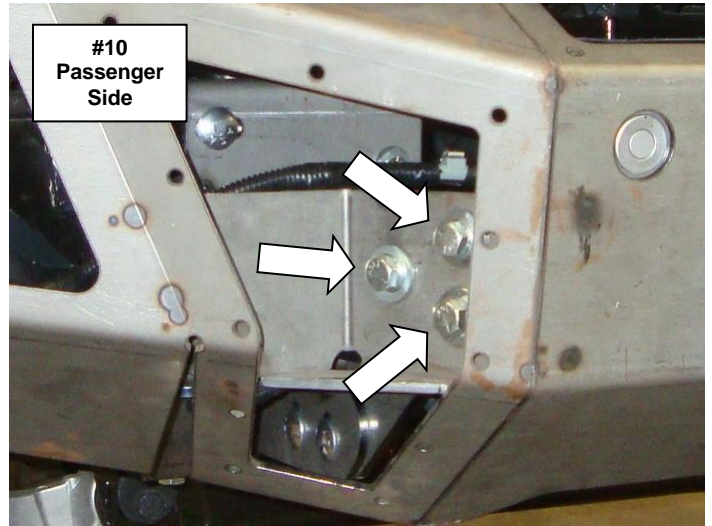
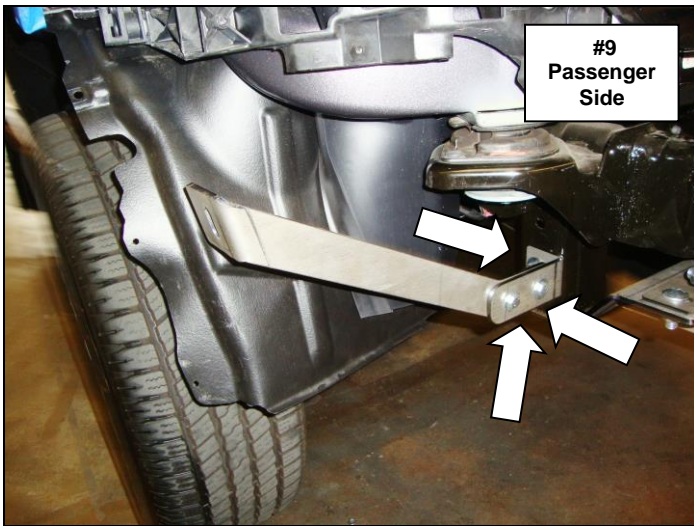

Step-17 Align the holes and attach bumper support bracket to each of the bumper shell support brackets using (1) 1/2" x 1 1/2" hex bolt, (2) 1/2" flat washers, (1) 1/2" lock washer and (1) 1/2" hex nut, (Photo 11).

Step-18 With assistance, adjust and hold the bumper shell visual alignment position, then tighten all nuts and bolts. Note: It may be necessary to loosen the nuts and bolts securing the mounting plate/winch tray and brackets, (Photo 12).

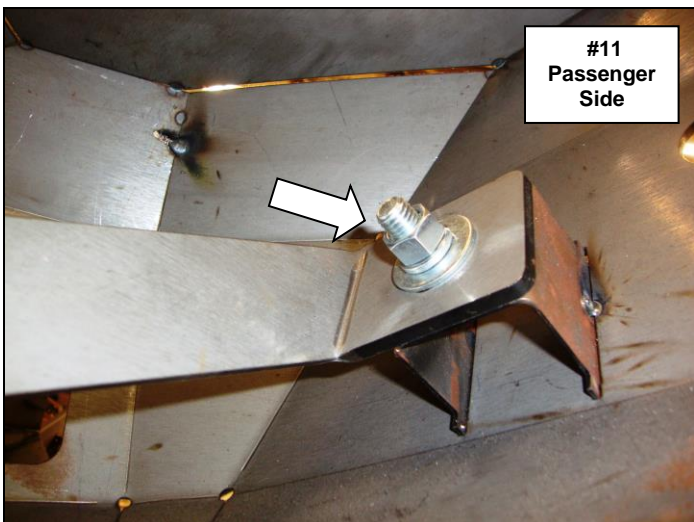

If installing a winch, install the roller fairlead to the bumper shell at this time. Refer to the winch manufacturer's instructions for installation. If installing an optional light bar, install the light bar to the bumper replacement at this time. Refer to the light bar instructions for installation.

Step-19 Install the driver and passenger side front vent covers and winch cover to the bumper shell using the supplied $\frac{1}{4}$ " x $\frac{3}{4}$ " button head bolts, (Photo 13). **Note:** Do not over tighten bolts, reference tightening torque (71 in. lbs.).

If your vehicle is equipped with front park assist reconnect the factory bumper wiring harness to the sensors and to the vehicle wiring harness prior to installing the winch cover.

Step-20 Install the flush mount light pods to the bumper shell using (4) $\frac{1}{4}$ " x $\frac{3}{4}$ " button head bolts and (4) $\frac{1}{4}$ " nylon lock nuts, (Photo 13).

Step-21 Re-connect the vehicle battery or batteries.

If your state law requires a front license plate, attach the license plate bracket to the holes in the face of the bumper shell, using the supplied $\frac{3}{8}$ " bolts, washers and nuts, and the license plate to the (2) obround holes in the license plate bracket using the supplied $\frac{1}{4}$ " bolts and nuts, (Photo 14).

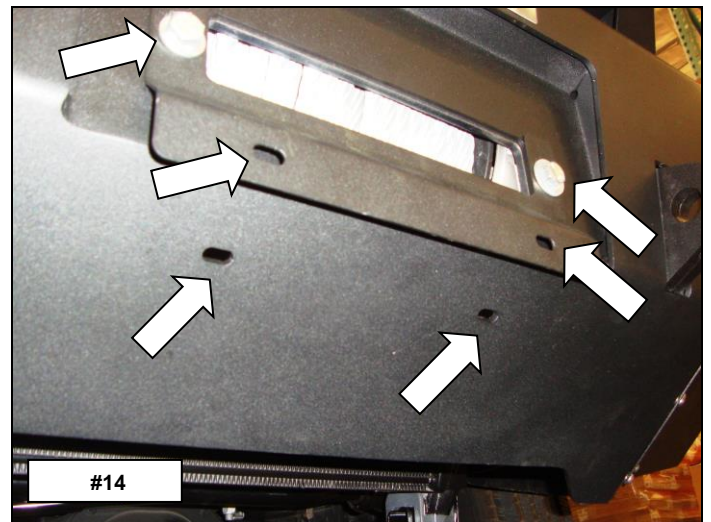
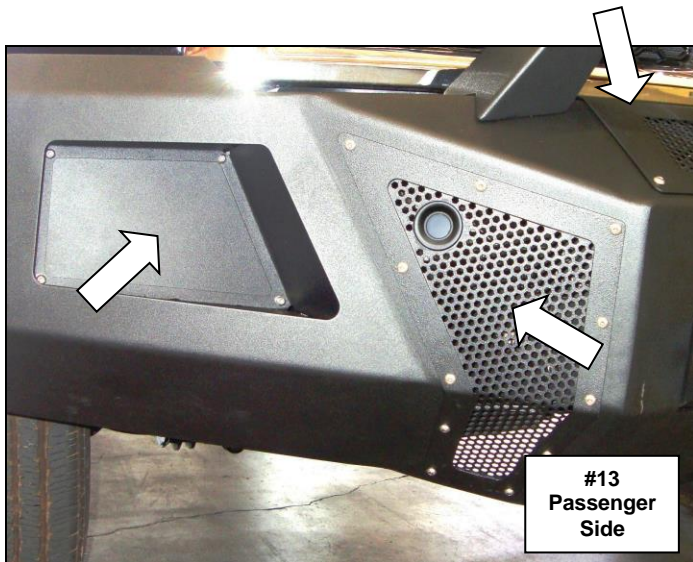

If installing a winch, attach the license plate directly to the (2) obround holes in the lower face of the bumper shell using the supplied $\frac{1}{4}$ " bolts and nuts, (Photo 14).

Remember to check and retighten all factory and supplied nuts and bolts periodically.