

Installation Instructions

BR20 Rear Bumper Replacement Part # 28128T

2013-2016 Ram 1500 2/4WD

Do not attempt to install this product on any vehicle other than the one listed above!

Parts List

Item	Qty.	Part #	Description	Item	Qty.	Part #	Description	Torque
1	1		Bumper Replacement Shell	10	6		Plastic Hole Plug	
2	1		Driver Side Frame Bracket	11	2		Flush Mount Light Pod Plate	
3	1		Driver Side Auxiliary Bracket	12	2		License Plate Light	
4	1		Passenger Side Frame Bracket	13	10		1/2" x 1 1/2" Hex Bolt	65 Ft. Lbs
5	1		Passenger Side Auxiliary Bracket	14	20		1/2" Flat Washer	
6	1		Bezel Plate (driver inner)	15	10		1/2" Lock Washer	
7	1		Bezel Plate (passenger inner)	16	10		1/2" Hex Nut	
8	1		Bezel Plate (driver outer)	17	10		10-32 x 3/4" Button Head Bolt	65 In. Lbs
9	1		Bezel Plate (passenger outer)	18	10		10-32 Nylon-Insert Lock Nut	

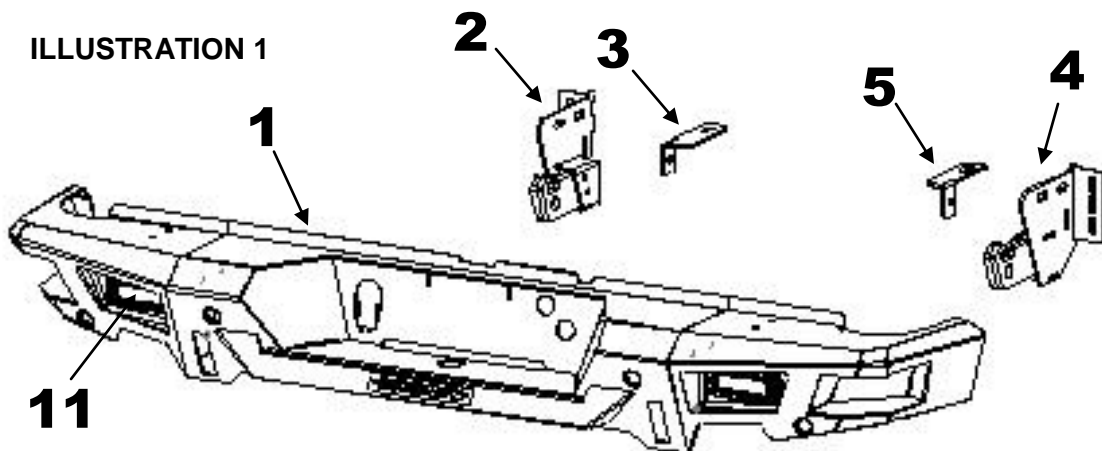

Tool Required:

- 15mm, 21mm, 3/8" & 3/4" Sockets & Wrenches
- Ratchet, Ratchet Extensions & Swivel Joint Adapter
- 1/8" Hex Key
- 12V Circuit Tester
- Screw Drivers

Approximate installation time: 90 min

Read the assembly and installation instructions completely and verify that all of the parts listed are accounted for. If you have defective, missing or damaged parts or need assistance, please contact *Go Rhino Products* for fast, friendly customer service at: Phone Number / 714-257-7392 / Fax Number / 714-672-0278 / email: warranty@gorhino.com

Factory Bumper Removal

Step-1 Disconnect the vehicle battery or batteries.

Step-2 Disconnect the wiring harness for the trailer plug, (Photo 1).

Step-3 Disconnect the license plate lights from the factory bumper, (Photo 2).

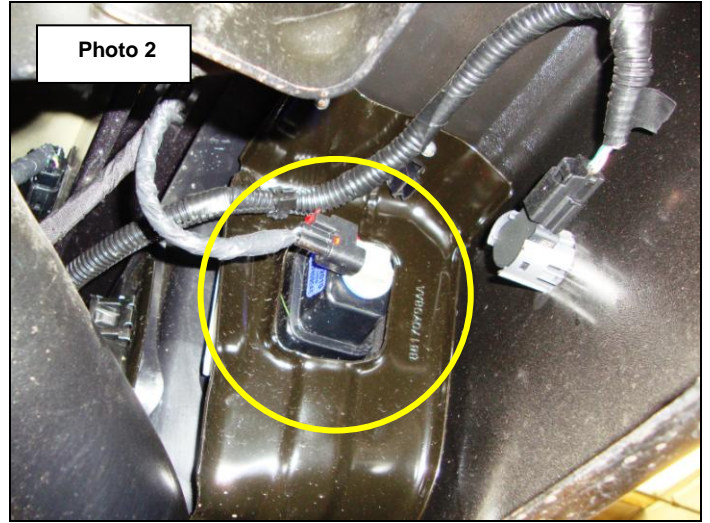
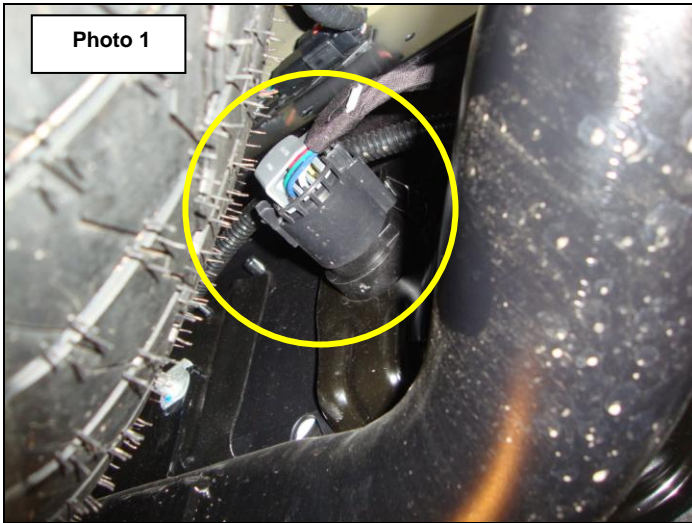

Step-4 Disconnect the factory bumper wiring harness from the vehicle wiring harness, (Photo 3).

Step-5 Remove the license plate from the factory bumper and the (2) bolts securing the factory bumper to the receiver hitch using a 15mm socket and ratchet, (Photo 4).

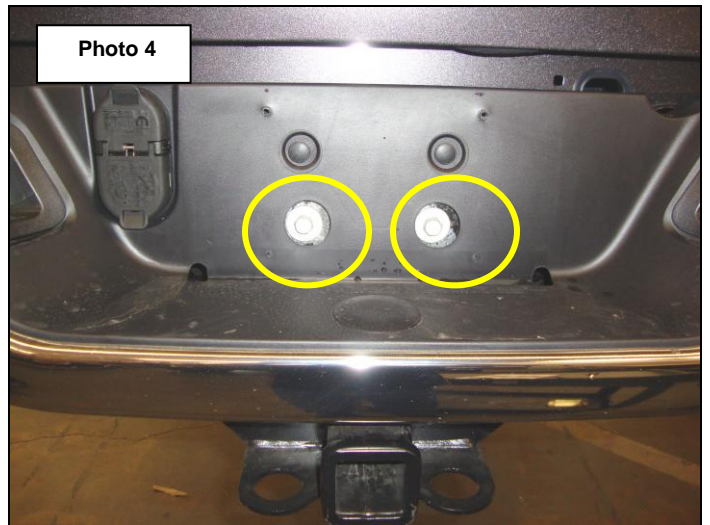
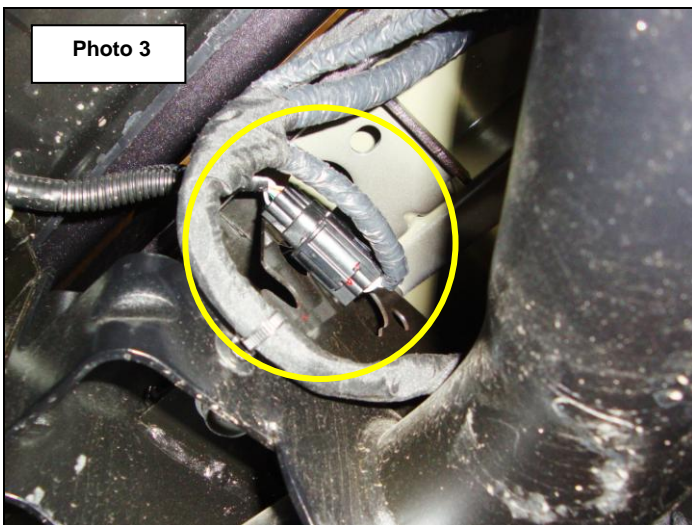

Step-5 Remove the bolts (2) per side securing the factory bumper brackets to the frame/receiver hitch using a 15mm socket and ratchet, (Photo 5).

Step 6 With Assistance, remove the factory bumper from the vehicle by rotating backwards to clear the boss located on the receiver hitch under the plastic center cover.

Step-7 Remove the bolts (1) per side securing the frame/receiver hitch to the bottom of the vehicle frame using a 21mm socket and ratchet, (Photo 6).

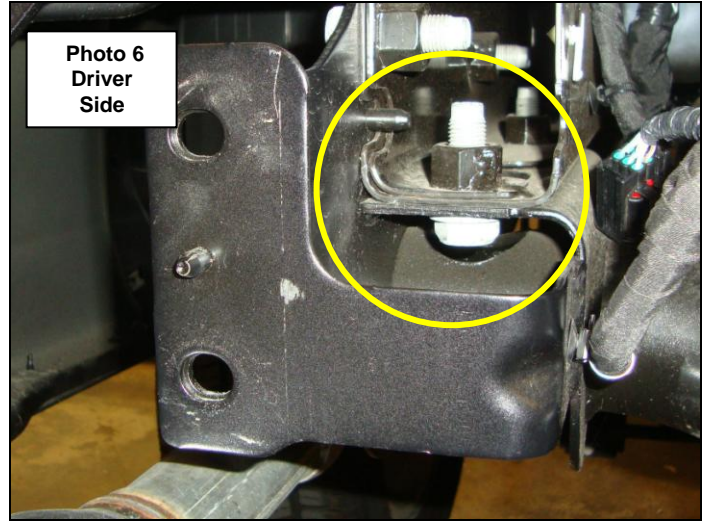
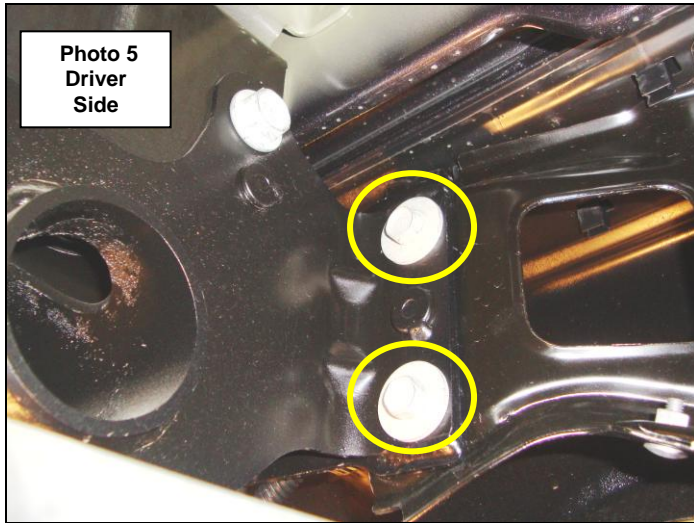

BR20 Bumper Replacement Installation

Note: if your vehicle is not equipped with rear Park Assist install the supplied plastic plugs in the holes in the replacement bumper and proceed to Step 8.

Note: If you are replacing a bumper with rear Park Assist, the sensor detection zone will be altered with use of this bumper replacement.

Step-1 If the vehicle is equipped with rear Park Assist, disconnect the sensors from the factory bumper wiring harness and remove the wiring harness from the bumper.

Step-2 Remove each sensor from the plastic bezel by gently spreading the bezel tabs and pulling out on the back of the sensor. Note: Do not push on the front of the sensor as this may damage the sensor.

Step 3 Remove the sensor bezels from the factory bumper by depressing the tabs around the base and pushing the bezel out through the front of the bumper. Note: The sensors and bezels have to be positioned in the replacement bumper in the same location (inner and outer), (driver and passenger) as removed from the factory bumper.

Step-4 Install the sensor bezels and sensors in the (inner and outer) bezel plates, (Illustration 1 & 2). Line up the protrusions on the bezel with the profile in the bezel plate; push the bezel through the profile in the plate until the tabs around the base lock in position, then install the sensor in the bezel. Note: The **U** notches in the bezel plate designate the top.

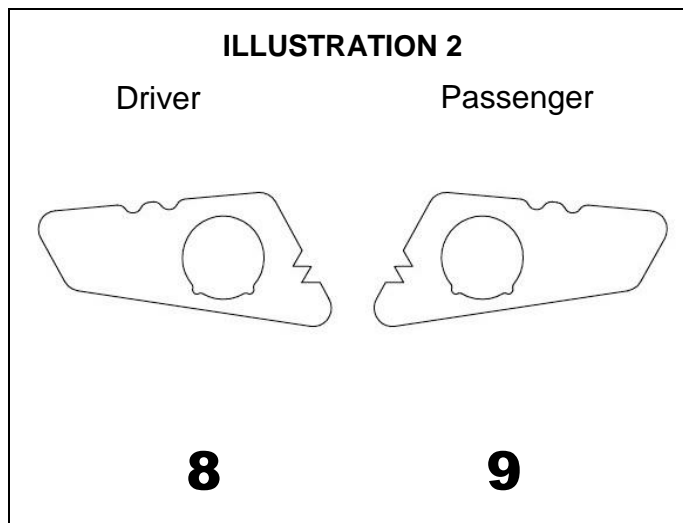
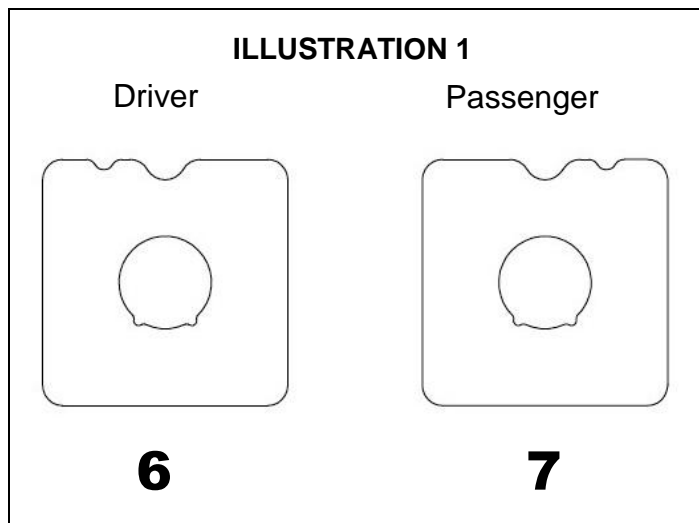

Step-5 Prepare the inside of the replacement bumper surface where the bezel plates will be mounted with Isopropyl alcohol. A clean, dry surface is required in order for tape to stick properly.

Step-6 Peel the backing off from the double sided tape to uncover the adhesive. From inside the replacement bumper position each bezel, sensor and bezel plate assembly, making sure the sensor bezel is centered in the hole provided in the replacement bumper, (Photo 3 & 4).

Step-7 Stick the assembly in place and apply firm pressure for about 30 seconds. The tape needs to bond with the mounting surface, and it needs pressure to do this. The bezel mounting plate will seem like it is stuck on, but continue pressing for at least 30 seconds. Note: At room temperature approximately 50% of ultimate bond strength will be achieved after 20 minutes, 90% after 24 hours and 100% after 72 hours.

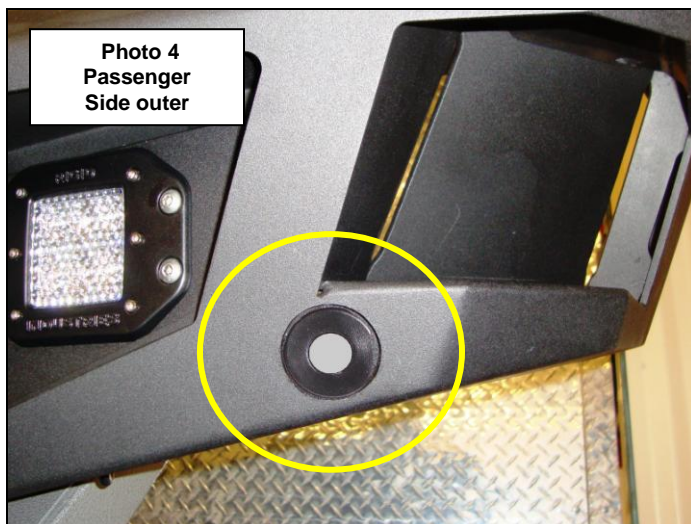
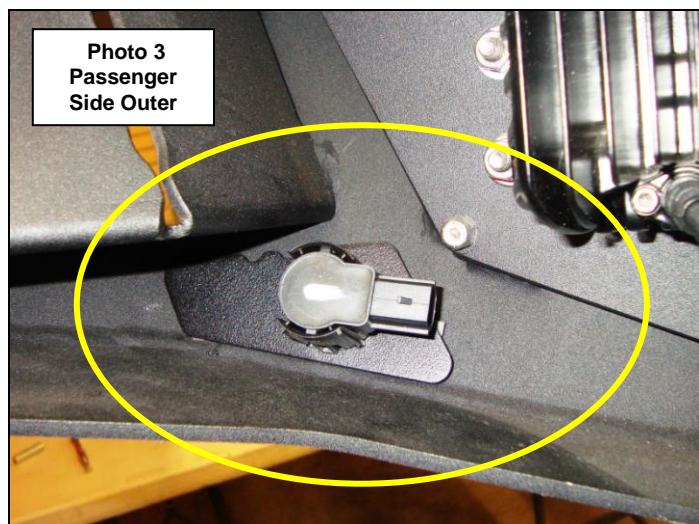

Step-8 Install the driver's side frame bracket by positioning the bracket on the frame/receiver hitch, align the holes and secure the bracket to the frame/receiver hitch using (2) ½" x 1 ½" hex bolts, (4) ½" flat washers, (2) ½" lock washers and (2) ½" hex nuts, (Photo 5). Leave the nuts and bolts loose for final adjustment.

Step-9 Position the driver side auxiliary bracket on the bottom of the frame/receiver hitch, align the hole in the bracket with the weld nut inside the frame and secure the auxiliary bracket to the vehicle frame using the factory bolt removed in step 7 of the factory bumper removal steps. Attach the opposite end of the auxiliary bracket to the side of the frame bracket using (1) ½" x 1 ½" hex bolt, (2) ½" flat washers, (1) ½" lock washer and (1) ½" hex nut, (Photo 6). Leave the nut and bolt loose for final adjustment.

Repeat steps 8 and 9 to install the passenger side frame and auxiliary bracket.

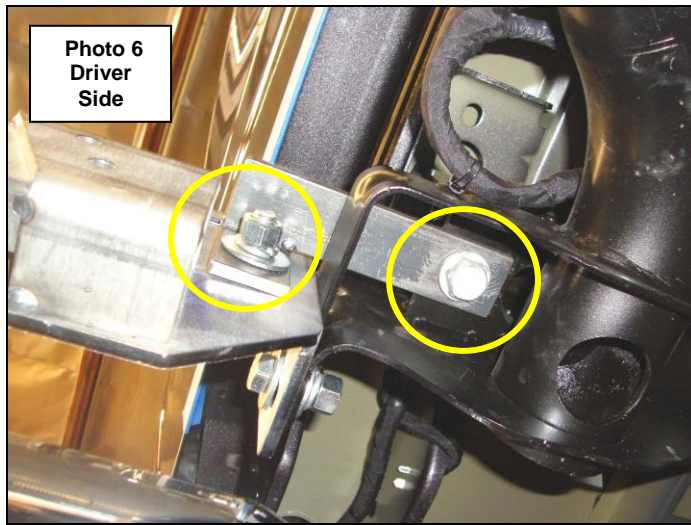
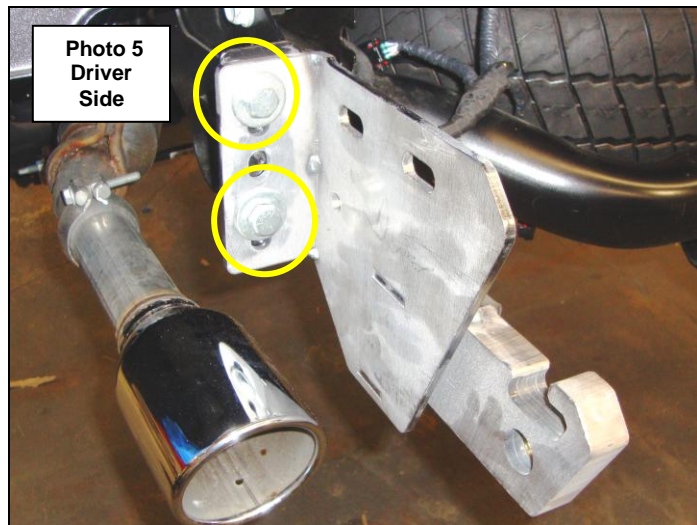

Step-10 With assistance attach the bumper shell brackets to each frame bracket using (2) ½" x 1 ½" hex bolts, (4) ½" flat washers, (2) ½" lock washers and (2) ½" Hex nuts, Align the bumper shell with the vehicle, verify that the tailgate clears when lowered, and tighten all nuts and bolts, (Photo 7). If necessary loosen the frame / receiver hitch bolts to adjust the bumper shell.

Step-11 Remove the trailer plug from the factory bumper and install it in the bumper shell, and reconnect the wiring harness, (Photo 8).

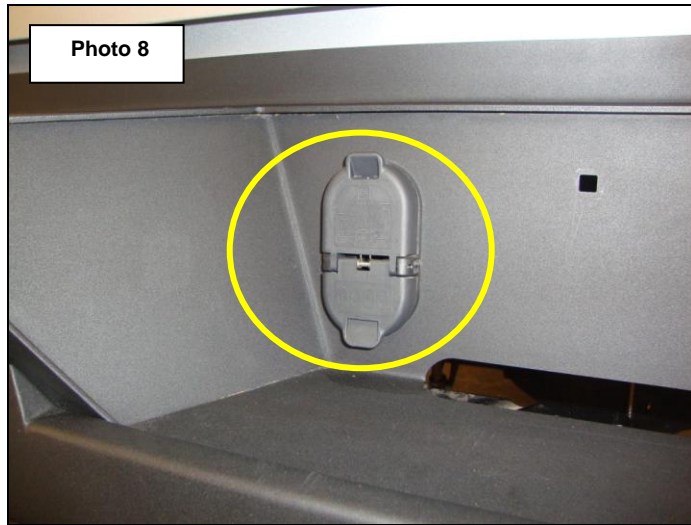
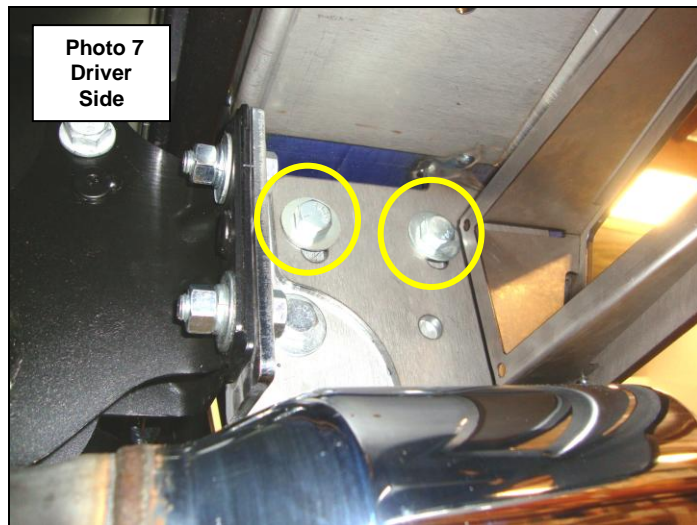

Step-12 Reconnect the factory bumper wiring harness to the sensors and to the vehicle wiring harness. Note: In order to connect the wiring harness to the (2) inner sensors the wires inside the conduit will require rerouting.

Step-13 Install the license plate using the supplied LED lights and fasteners to the bumper shell. Use a circuit tester to find the hot and ground from the factory license plate light wiring, and then splice the wires from the supplied lights.

Step-14 Install the supplied plastic plugs to fill the unused spare tire winch access tube holes in the bumper shell.

Step-15 Install the supplied flush mount light pods plates or optional light mounts to the rear bumper replacement using (4) 10-32 x $\frac{3}{4}$ " button head bolts and (4) 10-32 lock nuts.

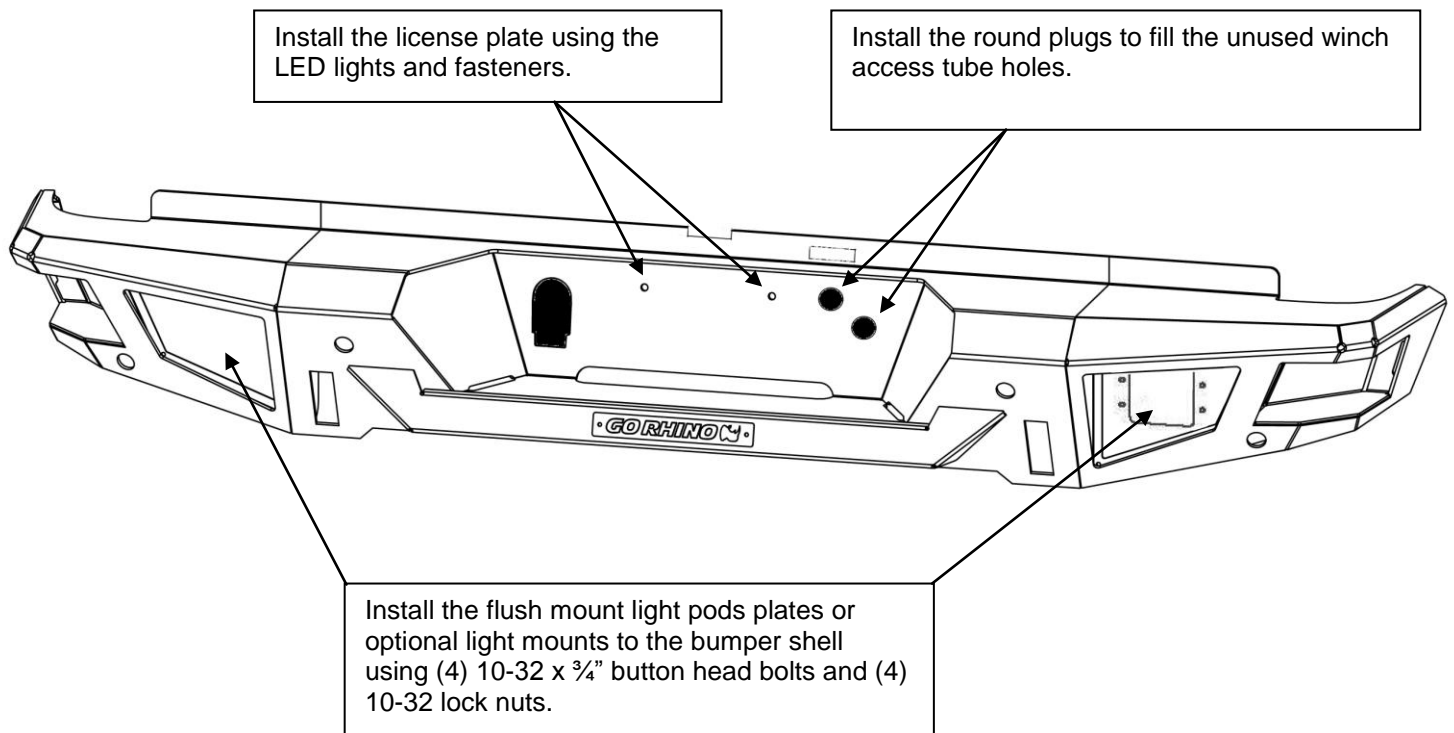

Step-16 Remember to check and retighten all factory and supplied nuts and bolts periodically.