

# Installation Instructions

I - Sheet Number LV919 Rev.B

# LUND®

## Ventvisor Elite™

**For proper installation and best possible fit, please read all instructions BEFORE you begin.  
For technical assistance or to obtain missing parts, please call Customer Relations at 1-800-241-7219.**

### Important Safety Information



- CAUTION - Before driving, ensure that the vent visors are properly secured to vehicle.
- Do not use automatic "brush-style" car washes.
- Do not use cleaning solvents of any kind.
- Periodically check all components for tightness.

### Contents - 2 Piece Set

**NOTE:** Actual product may vary from illustration.

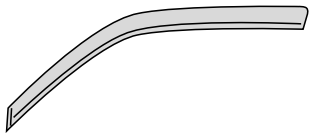

Front Driver Side Visor

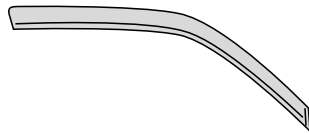

Front Passenger Side Visor



Alcohol Pad x2

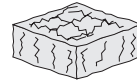

Scotch Brite Pad

### Contents - 4 Piece Set

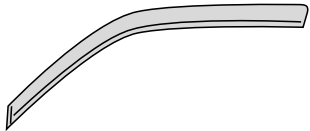

Front Driver Side Visor

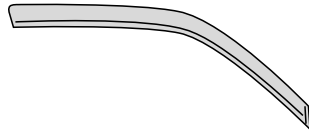

Front Passenger Side Visor



Rear Driver Side Visor



Rear Passenger Side Visor



Alcohol Pad x4



Scotch Brite Pad

### Tools Required



Car Wash Supplies

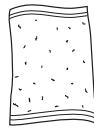

Clean Towel

### Preparation Before Painting / Installation

- A trial fit is recommended to ensure proper positioning and fit.
- Check fit of parts before painting as we will not accept the return of modified or painted parts.
- Wash your vehicle to remove any debris and/or dirt.
- Dry with a clean towel.

# Installation Steps

**NOTE:** Actual application may vary slightly from illustrations.



Roll down window. Buff the inside felt surface with scotch brite pad. Then clean with alcohol pad.

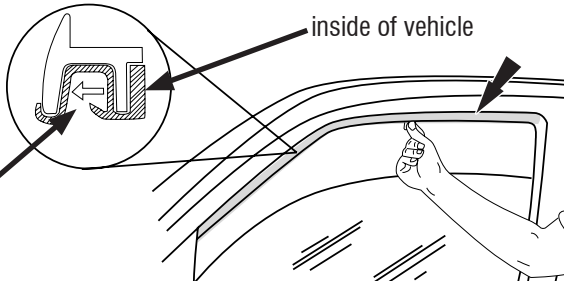

1

**NOTE:** visors mount on the **inside** of the window channel.

Remove the tape from the front and rear flanges. Peel back 2" (5cm) of tape liner from each end of top flange.

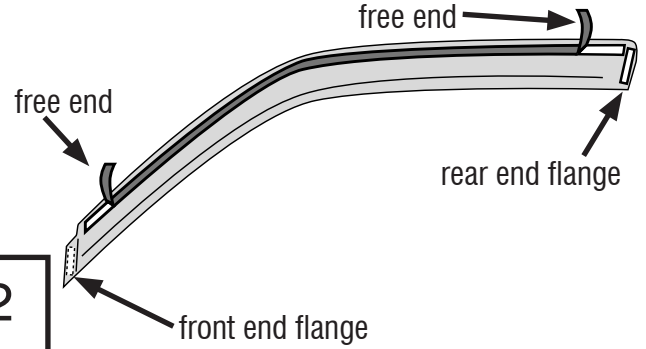

2

Slide the front end flange of the visor into position **outside** the window channel between the rubber trim and mirror cap. Then rotate visor up and slide top and rear flanges **inside** the window channel.

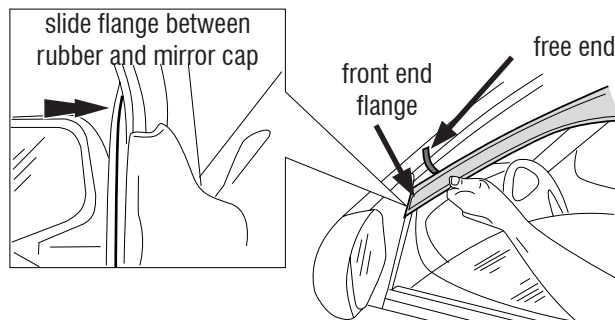

3

**NOTE:** Proper placement is important to prevent window from breaking flange during operation.

Press the exposed area of tape against the surface and verify position.

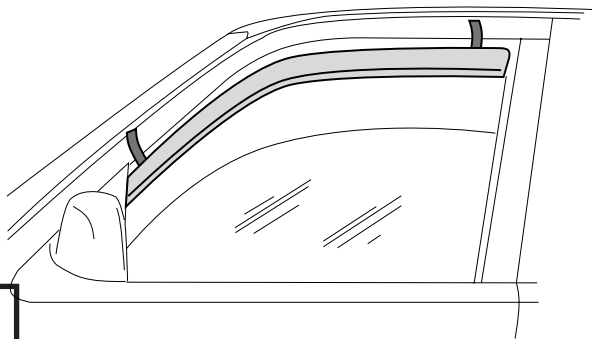

4

With the visor in its final position, remove the remainder of the tape liner by pulling on free ends.

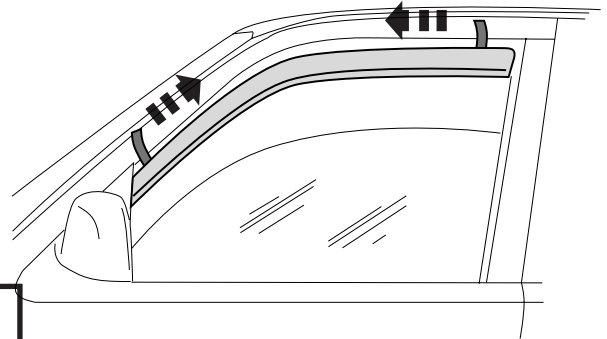

5

Apply pressure along the inside of window channel and flange edges to secure in place.

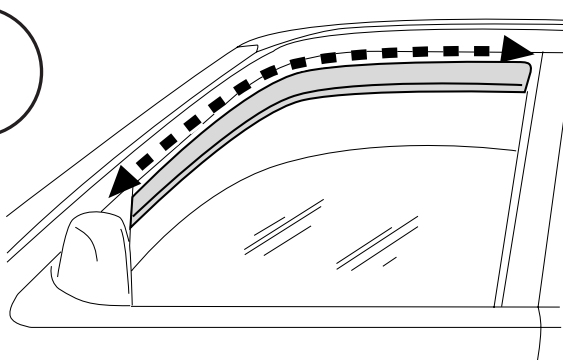

6

Roll up window and leave window up for 24 hours to ensure proper adhesion.

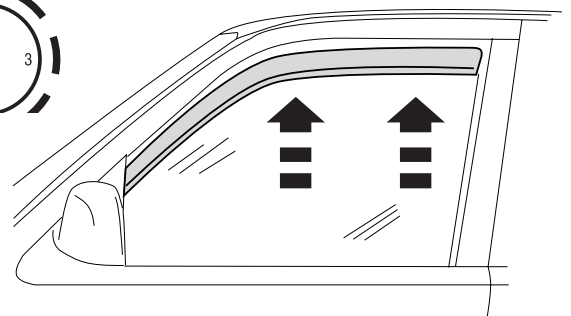

7

## 4 Piece Set

**NOTE:** Actual application may vary slightly from illustrations.

The drivers side rear visor attaches to the felt surface following the same procedure.

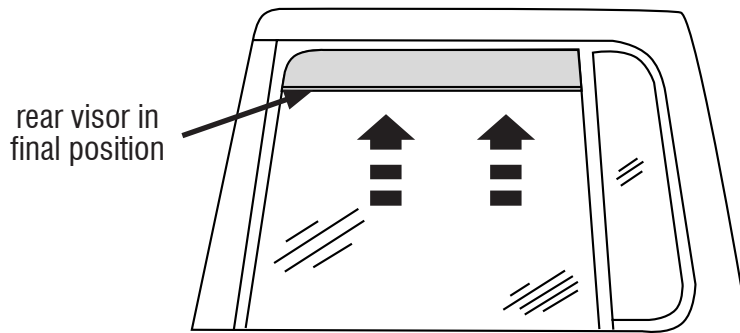

8

Repeat **Steps 1-8** for passenger side.

## Care and Cleaning

- Wash only with mild soap & dry with a clean cloth.

## Congratulations!

You have purchased one of the many quality Lund<sup>®</sup> branded products offered by Lund International, Inc. We take the utmost pride in our products and want you to enjoy years of satisfaction from your investment. We have made every effort to ensure that your product is top quality in terms of fit, durability, finish and ease of installation.

# LUND<sup>®</sup>

Lund International

800-241-7219 • Visit us at [lundinternational.com](http://lundinternational.com)

© 2014 Lund International, Inc. All rights reserved.

Lund<sup>®</sup> and the Lund<sup>®</sup> logo are trademarks of Lund International, Inc.



# LUND®

## Ventvisor Elite™

**Pour obtenir une installation correcte et le meilleur ajustement possible, lire toutes les instructions AVANT de commencer.**

**Pour toute assistance technique ou obtention de pièces manquantes, appeler le service des relations avec la clientèle au 1-800-241-7219.**

### Informations importantes concernant la sécurité



- ATTENTION – Avant de conduire, s'assurer que la visière est solidement assujettie sur le véhicule.
- Ne pas utiliser les stations de lavage de voitures à brosse.
- Ne pas utiliser de solvants.
- Vérifier régulièrement le serrage des composants.

### Contenu - Ensemble 2 pièces

**NOTE:** Le produit réel peut changer de l'illustration.

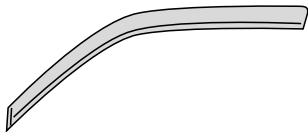

Visière avant  
côté conducteur

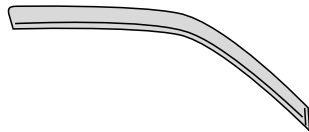

Visière avant  
côté passager



Tampons à  
l'alcool (2)



Garniture Écossaise  
De BRITE

### Contenu - Ensemble 4 pièces



Visière avant  
côté conducteur



Visière avant  
côté passager



Visière arrière  
côté conducteur



Visière arrière  
côté passager



Tampons à l'alcool (4)

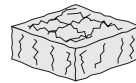

Garniture Écossaise De BRITE

### Outils nécessaires



Fournitures pour lavage de voiture



Serviette propre

### Préparation pour la peinture/l'installation

- Il est recommandé de procéder à un essai pour s'assurer que le positionnement et l'ajustement sont corrects.
- Vérifier l'ajustement des pièces avant peinture, car nous n'acceptons pas le retour de pièces modifiées ou peintes.
- Lavez votre véhicule pour enlever n'importe quels débris et/ou saleté..
- Séchez avec une serviette propre.

# Étapes d'installation

REMARQUE : La méthode d'application peut être légèrement différente de celle représentée par les illustrations.



Abaissez la glace. Polissez la surface de feutre intérieure avec un tampon Scotch Brite. Nettoyez-a ensuite avec un tampon à l'alcool.

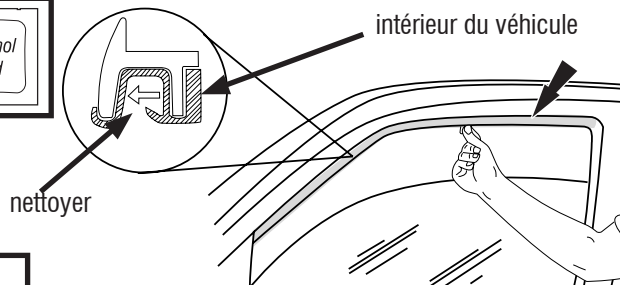

1

REMARQUE : Les visières se montent à l'intérieur de la glissière de la glace.

Retirez l'adhésif des rebords avant et arrière. Décollez 5 cm (2 po) de protection d'adhésif à chaque extrémité du rebord supérieur.

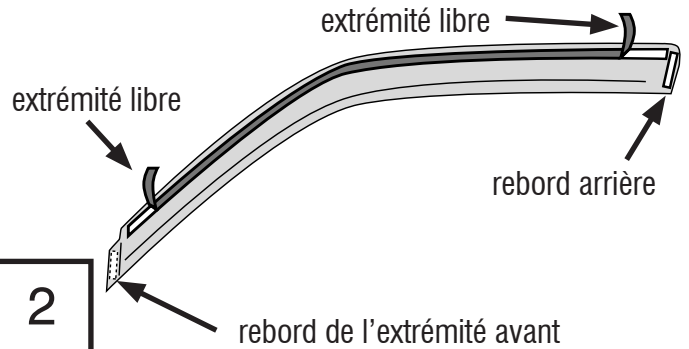

2

Glissez le rebord de l'extrémité avant de la visière en place **hors** de la glissière de la glace entre la garniture en caoutchouc et le couvercle du rétroviseur. Tournez ensuite la visière vers le haut et glissez les rebords supérieur et arrière **dans** la glissière de la glace.

glissez le rebord entre le caoutchouc et le couvercle du rétroviseur

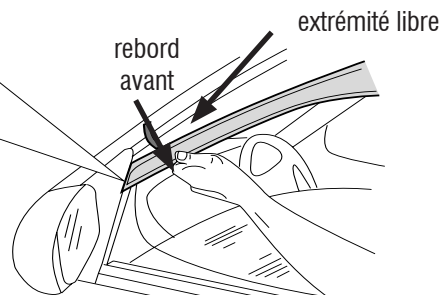
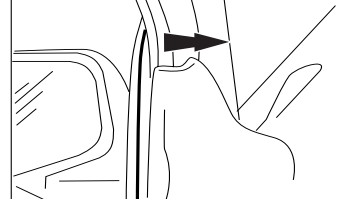

3

REMARQUE : Il est important de bien placer la glace pour éviter de briser le rebord pendant l'utilisation.

Poussez la région exposée de l'adhésif contre la surface et vérifiez-en la position.

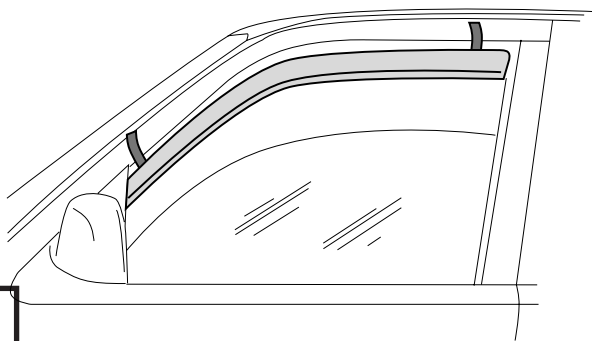

4

La visière se trouvant en position finale, retirez le reste de la protection d'adhésif en tirant sur les extrémités libres.

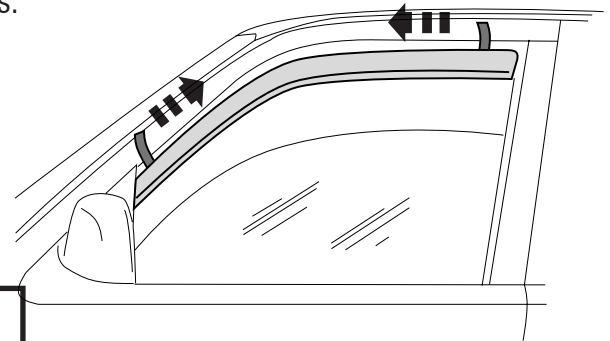

5

Exercez une pression le long de l'intérieur de la glissière de la glace et du rebord pour fixer le tout en place.

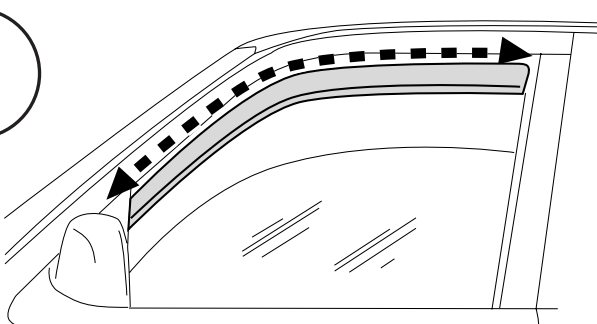

6

Relevez la glace et laissez-la remontée pendant 24 heures pour produire une bonne adhésion.

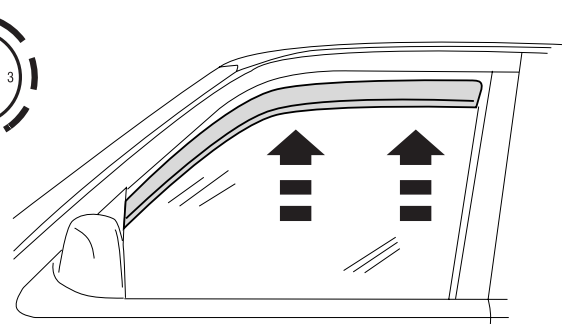

7

## Ensemble 4 pièces

REMARQUE : La méthode d'application peut être légèrement différente de celle représentée par les illustrations.

La visière arrière du côté conducteur se fixe à la surface de feutre au moyen de la même procédure.

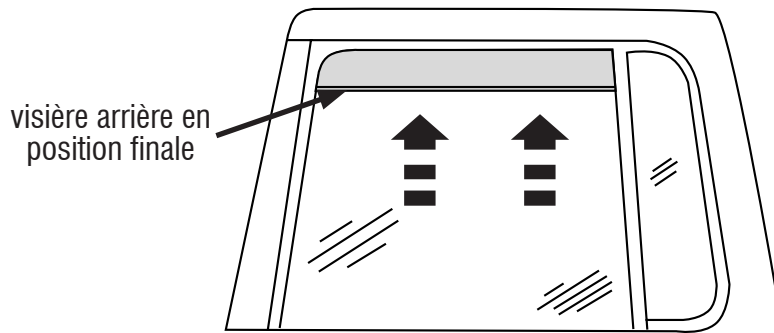

8

Répétez les étapes 1 à 8 du côté du passager.

## Entretien et nettoyage

- Laver exclusivement avec de l'eau savonneuse et sécher avec un chiffon propre.

## Félicitations !

Vous venez d'acheter un des nombreux produits de qualité de la marque Lund<sup>®</sup> fabriqués par Lund International, Inc. Nous sommes extrêmement fiers de la qualité de nos produits et nous espérons que vous profiterez de cet investissement de longues années durant. Nous nous efforçons d'offrir la meilleure qualité en termes d'ajustement, de finition, de durabilité et de facilité d'installation.

# LUND<sup>®</sup>

Lund International

800-241-7219 • Visitez notre site [lundinternational.com](http://lundinternational.com)

© 2014 Lund International, Inc. Tous droits réservés.

Lund<sup>®</sup> et le logo Lund<sup>®</sup> sont des marques déposées de Lund International, Inc.



# LUND

## Ventvisor Elite™

**Para una instalación adecuada y el mejor ajuste posible, lea todas las instrucciones ANTES de comenzar. Si desea recibir asistencia técnica u obtener piezas faltantes, llame al Servicio al cliente al 1-800-241-7219.**

### Información importante de seguridad



- PRECAUCIÓN - Antes de conducir, asegúrese de que la visera deflectora esté correctamente anclada al vehículo.
- No utilice servicios automáticos de limpieza de vehículos que utilizan cepillos.
- No utilice limpiadores al solvente de ningún tipo.
- Compruebe periódicamente que todos los componentes estén ajustados.

### Contenido - Juego de dos piezas **NOTA:** El producto real puede variar de la ilustración.



Visera del conductor



Visera del acompañante



Paño esterilizado (2)

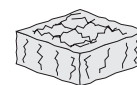

Cojín Escocés Del Brite

### Contenido - Juego de cuatro piezas



Visera del conductor

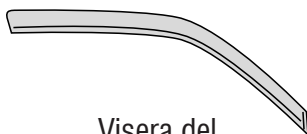

Visera del acompañante



Visera trasera lateral izquierdo



Visera trasera lateral derecho



Paño esterilizado (4)

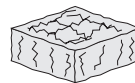

Cojín Escocés Del Brite

### Herramientas necesarias



Equipo de limpieza de vehículos



Toalla limpia

### Preparación antes de pintar o instalar

- Se recomienda realizar un ajuste de prueba para asegurar el posicionamiento y ajuste correctos.
- Compruebe que las piezas se ajusten correctamente antes de pintarlas, ya que no aceptaremos la devolución de piezas modificadas o pintadas.
- Lave su vehículo para quitar cualquier ruina y/o suciedad.
- Séchez avec une serviette propre.

# Pasos de instalación

**AVISO:** La colocación real puede variar con respecto a las ilustraciones.



Baje la ventanilla. Pula la superficie de fieltro con un paño para restregar Scotch Brite. Luego limpie con un paño esterilizado.

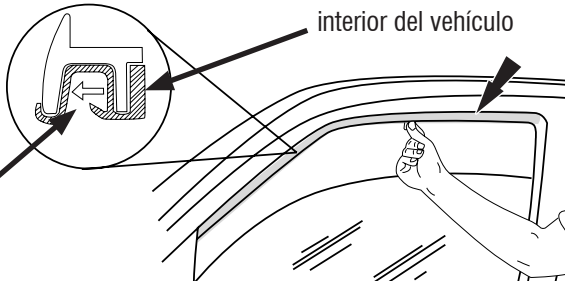

1

**AVISO:** las viseras se colocan **en la parte interior** del canal de la ventanilla.

Quite la cinta del reborde frontal y trasero. Retire 2 pulgs. (5 cm) de cinta protectora de cada uno de los extremos del reborde superior.

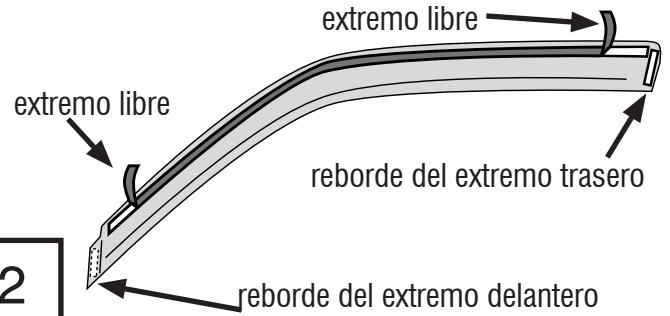

2

Deslice el rebordo del extremo delantero de la visera en su lugar **en el exterior** del canal de la ventanilla entre la banda de goma y la cubierta del espejo. Luego gire la visera hacia arriba y deslice el rebordo superior y el trasero **dentro** del canal de la ventanilla.

deslice el rebordo entre la goma y la cubierta del espejo

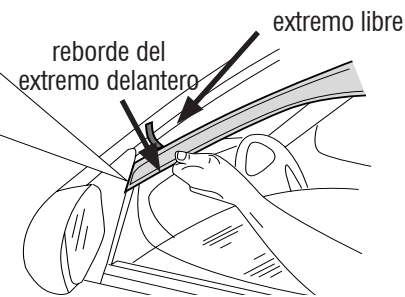
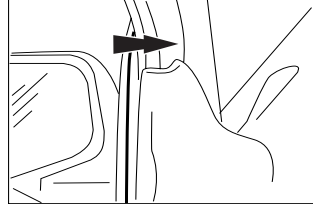

3

**AVISO:** La colocación adecuada es importante para evitar que la ventanilla rompa el rebordo durante la operación.

Presione la cinta expuesta sobre la superficie y verifique la posición.

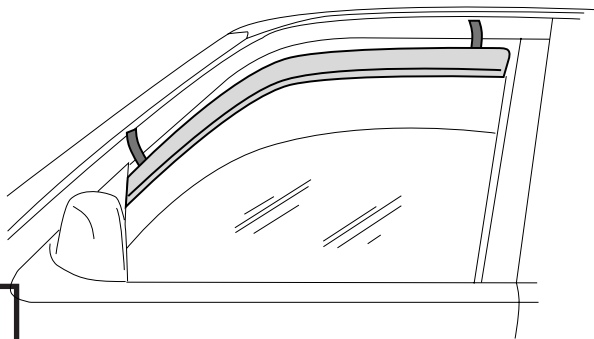

4

Con la visera en su posición definitiva, quite la cinta protectora restante tirando de los extremos que quedaron libres.

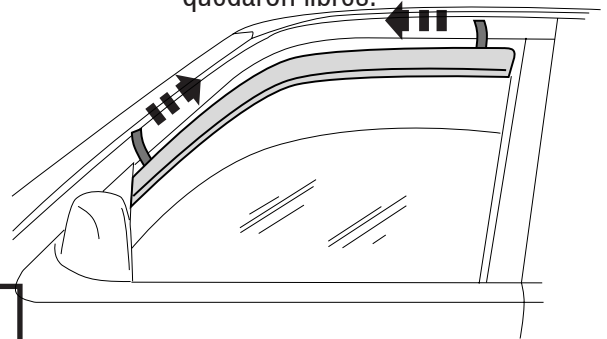

5

Presione el interior del canal de la ventanilla y los bordes del rebordo para asegurarlo en su lugar.

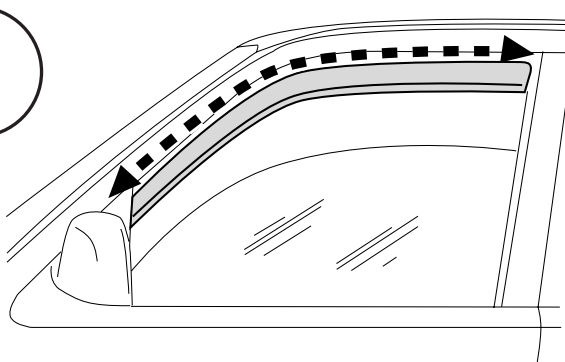

6

Cierre la ventanilla por 24 horas para asegurarse de que se adhiera correctamente.

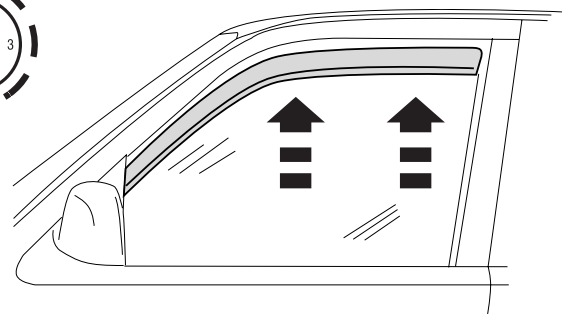

7



## Juego de cuatro piezas

**AVISO:** La colocación real puede variar con respecto a las ilustraciones.

La visera trasera del conductor se fija a la superficie de fieltro siguiendo el mismo procedimiento.

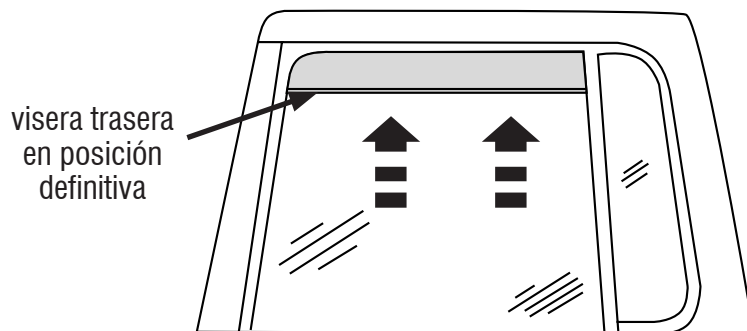

8

Repita los pasos 1 a 8 para el lado del acompañante.

## Cuidado y limpieza

- Limpie solamente con agua jabonosa tibia y seque con un paño limpio.

## Felicidades

Usted ha adquirido uno de los tantos productos de calidad de marca Lund<sup>®</sup> que ofrece Lund International, Inc. Nos enorgullecen mucho nuestros productos y deseamos que disfrute años de satisfacción por su inversión. Nos hemos esforzado mucho para asegurarnos de que su producto sea de gran calidad en cuanto a ajuste, durabilidad, acabado y facilidad de instalación.

# LUND<sup>®</sup>

Lund International

800-241-7219 • Visite nuestro sitio Web: [lundinternational.com](http://lundinternational.com)

© 2014 Lund International, Inc. Todos los derechos reservados.

Lund<sup>®</sup> y el logo de Lund<sup>®</sup> son marcas registradas de Lund International, Inc.

