



Ventvisor Elite™

**For proper installation and best possible fit, please read all instructions BEFORE you begin.
For technical assistance or to obtain missing parts, please call Customer Relations at 1-800-241-7219.**

Important Safety Information



- CAUTION - Before driving, ensure that the vent visor is properly secured to vehicle.
- Do not use automatic "brush-style" car washes.
- Do not use cleaning solvents of any kind.
- Periodically check all components for tightness.

Contents - 2 Piece Set **NOTE:** Actual product may vary from illustration.

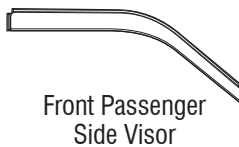
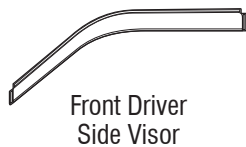

Alcohol Pad x2

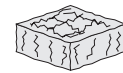

Scotch Brite Pad

Contents - 4 Piece Set

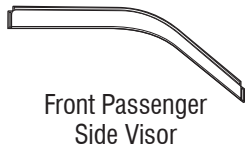
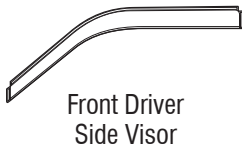

Alcohol Pad x4



Scotch Brite Pad

Tools Required



Car Wash Supplies



Clean Towel

Preparation Before Painting / Installation

- A trial fit is recommended to ensure proper positioning and fit.
- Check fit of parts before painting as we will not accept the return of modified or painted parts.
- Wash and dry your vehicle to remove any debris and/or dirt from the installation area.

Installation Steps **NOTE:** Actual application may vary slightly from illustrations.



Roll down window. Buff the inside felt surface with scotch brite pad. Then clean with alcohol pad.

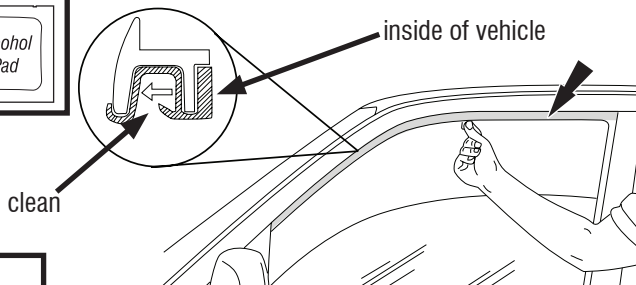

1

NOTE: visors mount on the **inside** of the window channel.

Remove tape liner from front & rear flanges. Peel back 2" of tape line from each end of top flange.

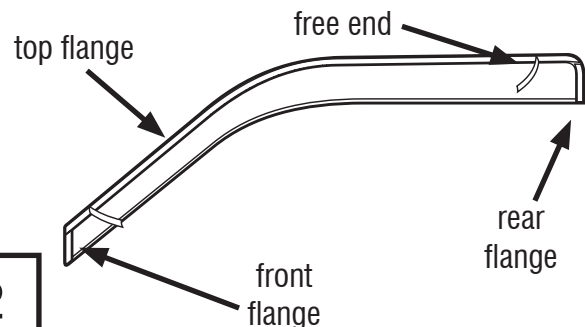

2

Installation Steps

NOTE: Actual application may vary slightly from illustrations.

Insert visor into window channel, rear flange first.

3

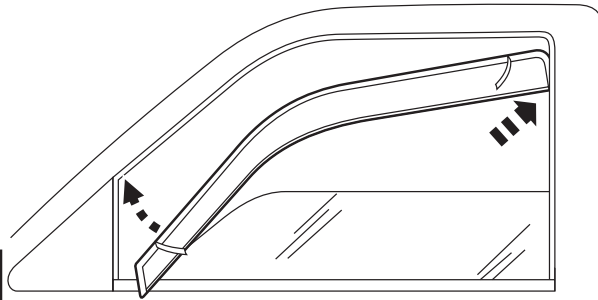

Press the exposed area of tape against the surface and verify position.

4

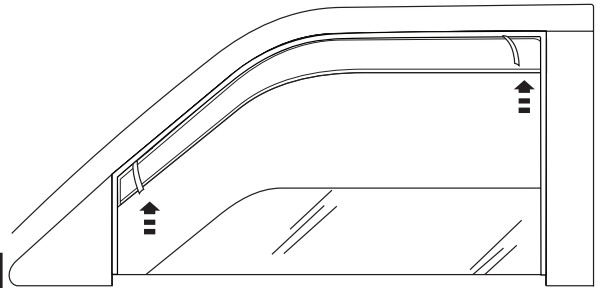

With the visor in its final position, remove the remainder of the tape liner by pulling on free ends.

5

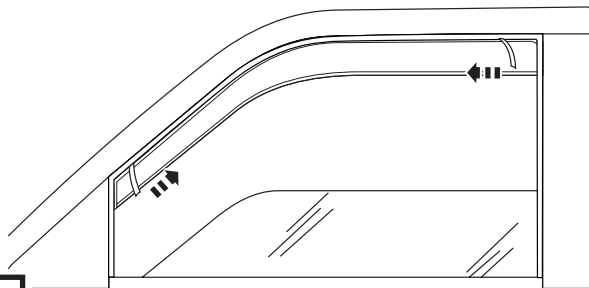

Apply pressure along the inside of window channel and flange edges to secure in place.

6

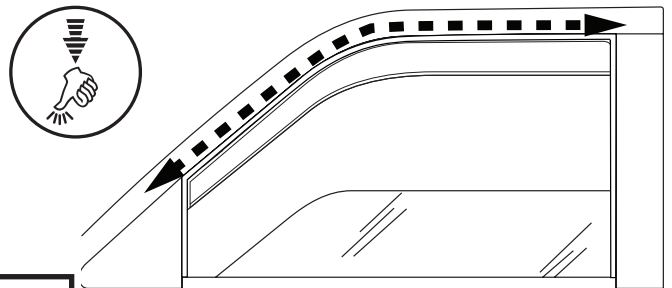

Continue to apply pressure to ensure that the visor remains properly seated inside the window channel as window is slowly closed. Leave window up for 72 hours to secure visor to window channel.

7

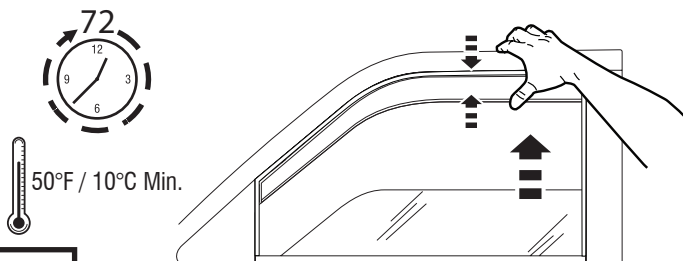

4 Piece Set

Install the rear visors using the same preparation and installation methods as the front visor. Note that rear flange fits between the rubber and post.

8

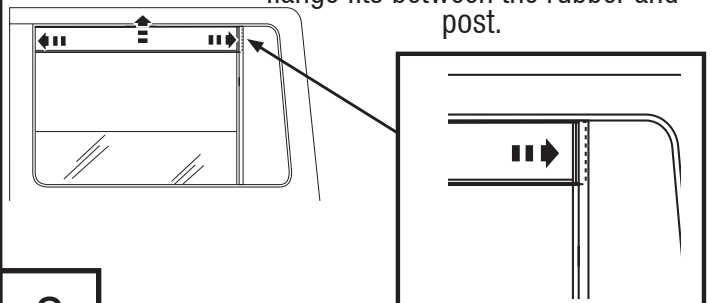

Repeat steps 1 thru 8 for passenger side

Care and Cleaning

- Wash only with mild soap & dry with a clean cloth.

Congratulations!

You have purchased one of the many quality Lund[®] branded products offered by Lund International, Inc. We take the utmost pride in our products and want you to enjoy years of satisfaction from your investment. We have made every effort to ensure that your product is top quality in terms of fit, durability, finish and ease of installation.

LUND[®]

Lund International

800-241-7219 • Visit us at lundinternational.com

© 2012 Lund International, Inc. All rights reserved.

Lund[®] and the Lund[®] logo are trademarks of Lund International, Inc.



LUND®

Ventvisor Elite™

Pour obtenir une installation correcte et le meilleur ajustement possible, lire toutes les instructions **AVANT** de commencer.
 Pour toute assistance technique ou obtention de pièces manquantes, appeler le service des relations avec la clientèle au
1-800-241-7219.

Informations importantes concernant la sécurité



- **ATTENTION** – Avant de conduire, s'assurer que la visière est solidement assujettie sur le véhicule.
- Ne pas utiliser les stations de lavage de voitures à brosses.
- Ne pas utiliser de solvants.
- Vérifier régulièrement le serrage des composants.

Contenu - Ensemble 2 pièces

NOTE: Le produit réel peut changer de l'illustration.

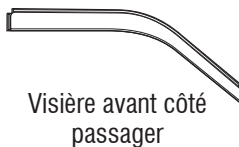

Tampons à l'alcool
(2)

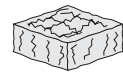

Garniture Écossaise De BRITE

Contenu - Ensemble 4 pièces

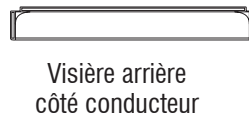
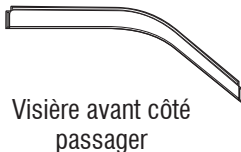

Tampons à l'alcool (4)



Garniture Écossaise De BRITE

Outils nécessaires



Fournitures pour lavage de voiture



Serviette propre

Préparation pour la peinture/l'installation

- Il est recommandé de procéder à un essai pour s'assurer que le positionnement et l'ajustement sont corrects.
- Vérifier l'ajustement des pièces avant peinture, car nous n'acceptons pas le retour de pièces modifiées ou peintes.
- Laver les glissières de glaces de la portière du véhicule pour éliminer toute poussière et tous débris.
- Sécher les glissières avec une serviette propre.

Étapes d'installation

REMARQUE : La méthode d'application peut être légèrement différente de celle représentée par les illustrations.



Abaissez la glace. Polissez la surface de feutre intérieure avec un tampon Scotch Brite. Nettoyez-a ensuite avec un tampon à l'alcool.

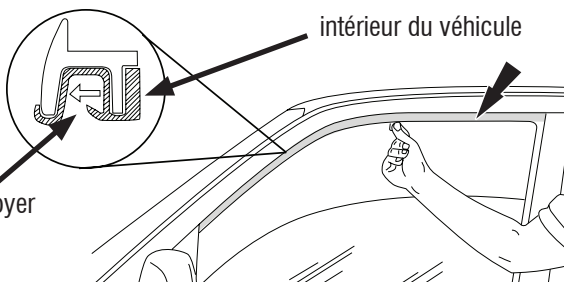

1

REMARQUE : Les visières se montent à l'intérieur de la glissière de la glace.

Retirez la protection d'adhésif des rebords avant et arrière. Décollez environ 5 cm (2 po) de protection d'adhésif à chaque extrémité du rebord supérieur.

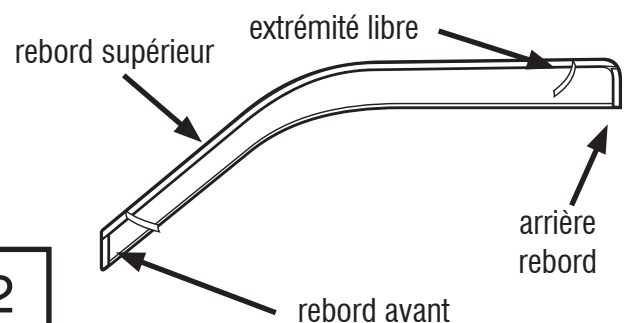

2

Étapes d'installation

REMARQUE : La méthode d'application peut être légèrement différente de celle représentée par les illustrations.

Insérez le rebord arrière de la visière dans la glissière de glace en premier.

3

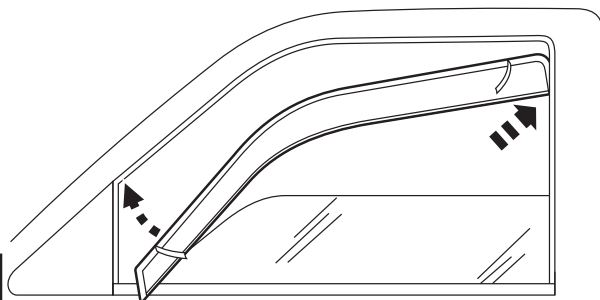

Poussez la région exposée de l'adhésif contre la surface et vérifiez-en la position.

4

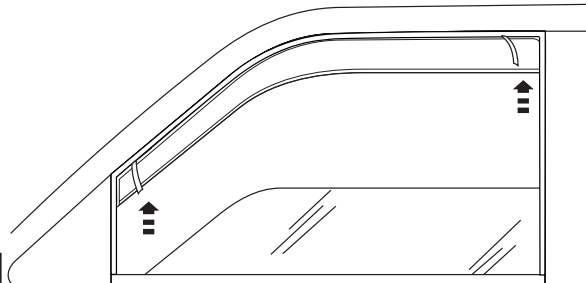

La visière se trouvant en position finale, retirez le reste de la protection d'adhésif en tirant sur les extrémités libres.

5

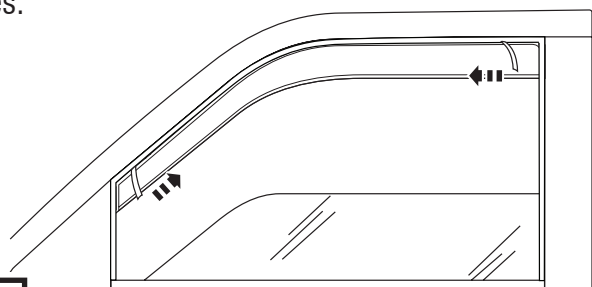

Exercez une pression le long de l'intérieur de la glissière de la glace et du rebord pour fixer le tout en place.

6

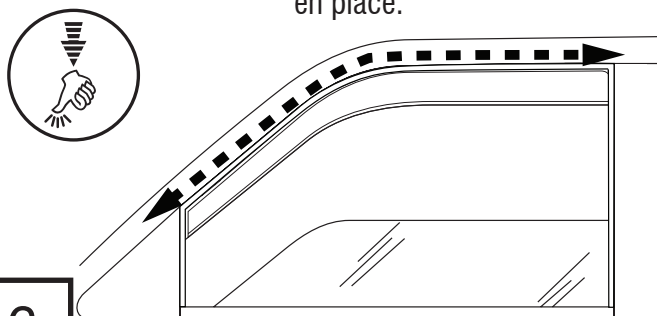

Continuez à maintenir la pression pour que le pare-soleil reste positionné correctement dans le canal de la glace, tout en fermant la glace lentement. Laissez la glace en position relevée pendant 72 heures pour bien fixer le pare-soleil au canal de la glace.

7

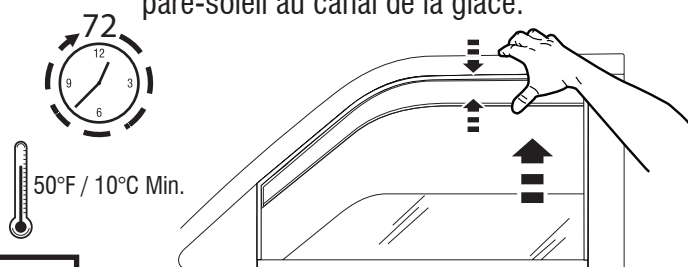

Ensemble 4 pièces

Installez la visière

arrière en utilisant la même méthode de préparation et d'installation que pour la visière avant. Notez que le rebord arrière se loge entre le caoutchouc et le montant.

8

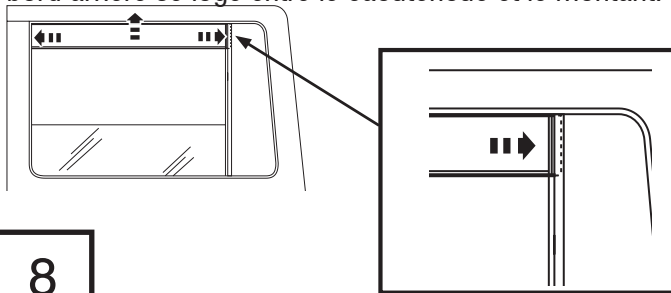

Répétez les étapes 1 à 8 pour le côté passager.

Entretien et nettoyage

- Laver exclusivement avec de l'eau savonneuse et sécher avec un chiffon propre.

Félicitations !

Vous venez d'acheter un des nombreux produits de qualité de la marque Lund[®] fabriqués par Lund International, Inc. Nous sommes extrêmement fiers de la qualité de nos produits et nous espérons que vous profiterez de cet investissement de longues années durant. Nous nous efforçons d'offrir la meilleure qualité en termes d'ajustement, de finition, de durabilité et de facilité d'installation.

LUND[®]

Lund International

800-241-7219 • Visitez notre site lundinternational.com

© 2015 Lund International, Inc. Tous droits réservés.

Lund[®] et le logo Lund[®] sont des marques déposées de Lund International, Inc.



Ventvisor Elite™

Para una instalación adecuada y el mejor ajuste posible, lea todas las instrucciones ANTES de comenzar. Si desea recibir asistencia técnica u obtener piezas faltantes, llame al Servicio al cliente al 1-800-241-7219.

Información importante de seguridad



- PRECAUCIÓN - Antes de conducir, asegúrese de que la visera esté correctamente anclada al vehículo.
- No utilice servicios automáticos de limpieza de vehículos que utilizan cepillos.
- No utilice limpiadores al solvente de ningún tipo.
- Compruebe periódicamente que todos los componentes estén ajustados.

Contenido - Juego de dos piezas

NOTA: El producto real puede variar de la ilustración.



Paños esterilizados x 2



Contenido - Juego de cuatro piezas

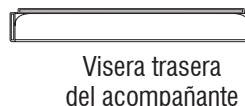

Paños esterilizados x 4



Herramientas necesarias



Preparación antes de pintar o instalar

- Se recomienda realizar un ajuste de prueba para asegurar el posicionamiento y ajuste correctos.
- Compruebe que las piezas se ajusten correctamente antes de pintarlas, ya que no aceptaremos la devolución de piezas modificadas o pintadas.
- Lave los canales de la ventanilla del vehículo para quitar los desechos y la suciedad.
- Seque los canales de la ventanilla con una toalla limpia.

Pasos de instalación

AVISO: La colocación real puede variar con respecto a las ilustraciones.



Baje la ventanilla. Pula la superficie de fieltro con un paño para restregar Scotch Brite. Luego limpie con un paño esterilizado.

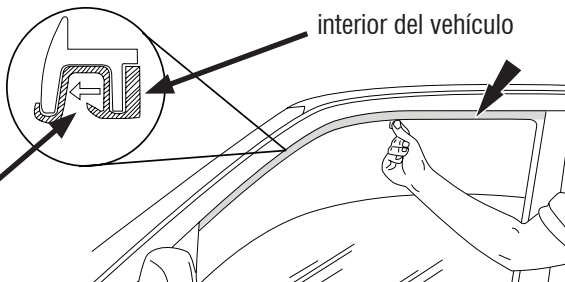

1

AVISO: las viseras se colocan en la parte interior del canal de la ventanilla.

Quite la cinta protectora de los rebordes frontales y traseros. Retire 2 pulgs. (5 cm) de cinta protectora de cada uno de los extremos del reborde superior.

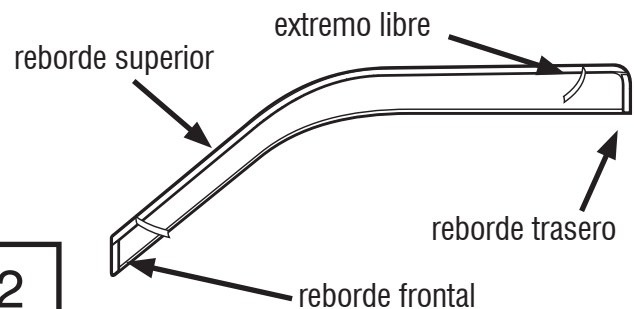

2

Pasos de instalación

AVISO: La colocación real puede variar con respecto a las ilustraciones.

Coloque la visera en el canal de la ventanilla comenzando por el reborde trasero.

3

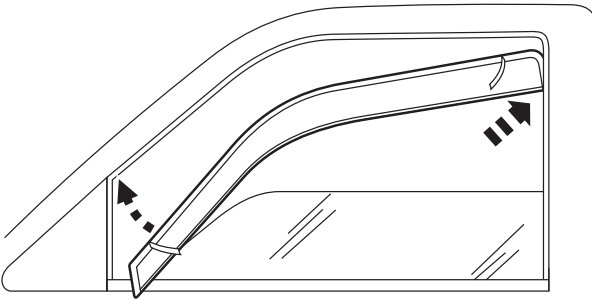

Presione la cinta expuesta sobre la superficie y verifique la posición.

4

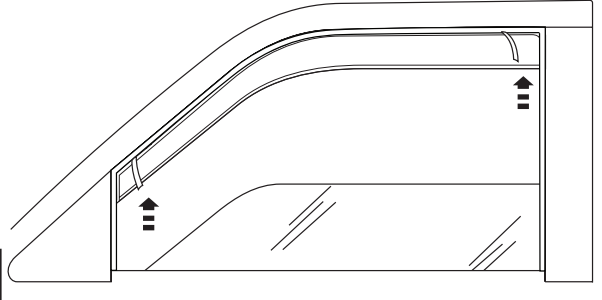

Con la visera en su posición definitiva, quite la cinta protectora restante tirando de los extremos que quedaron libres.

5

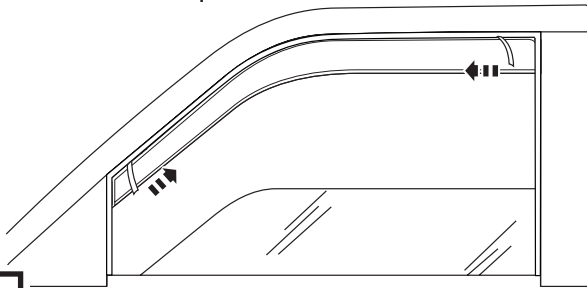

Presione el interior del canal de la ventanilla y los bordes del reborde para asegurarlo en su lugar.

6

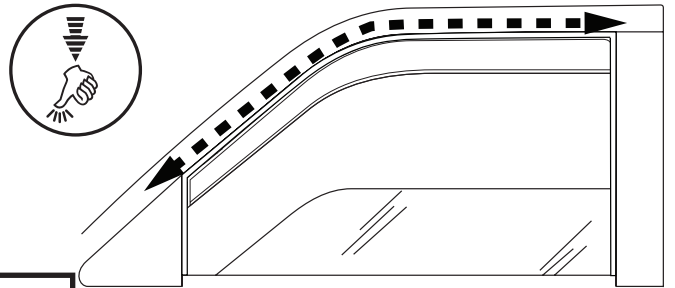

Continúe aplicando presión para asegurarse de que el visor encaje correctamente dentro del canal de la ventana ya que la ventana se cierra lentamente. Suba la ventana durante 72 horas para asegurar el visor en el canal de la ventana.

7

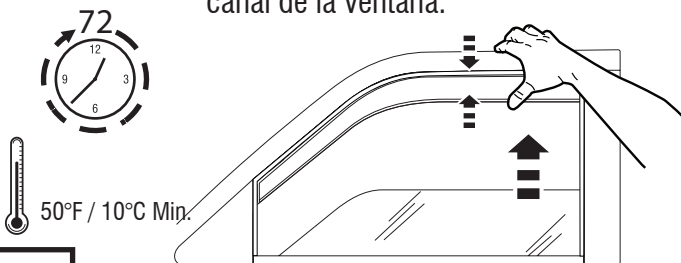

Juego de cuatro piezas

Instale las viseras

traseras con los mismos métodos de preparación e instalación que utilizó para la visera delantera. Tenga en cuenta que el reborde trasero se coloca entre la goma y el poste.

8

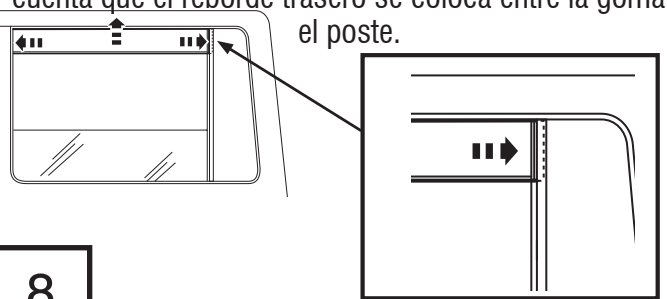

Repita los pasos 1 a 8 en el lado del pasajero.

Cuidado y limpieza

- Limpie solamente con agua jabonosa tibia y seque con un paño limpio.

Felicidades

Usted ha adquirido uno de los tantos productos de calidad de marca Lund[®] que ofrece Lund International, Inc. Nos enorgullecen mucho nuestros productos y deseamos que disfrute años de satisfacción por su inversión. Nos hemos esforzado mucho para asegurarnos de que su producto sea de gran calidad en cuanto a ajuste, durabilidad, acabado y facilidad de instalación.

LUND[®]

Lund International

800-241-7219 • Visite nuestro sitio Web: lundinternational.com

© 2015 Lund International, Inc. Todos los derechos reservados.

Lund[®] y el logo de Lund[®] son marcas registradas de Lund International, Inc.

