

AMP RESEARCH BedStep2™

Toyota Tundra CrewMax
2007-2012

PART NUMBER:
75405-01A

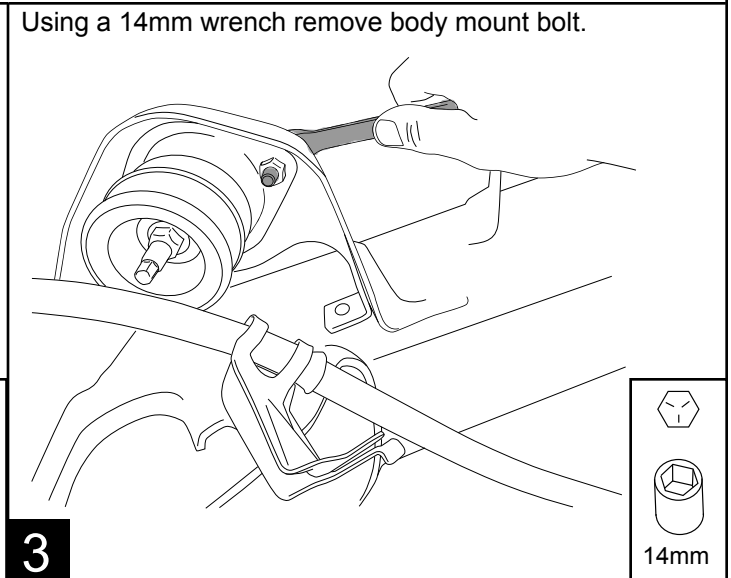
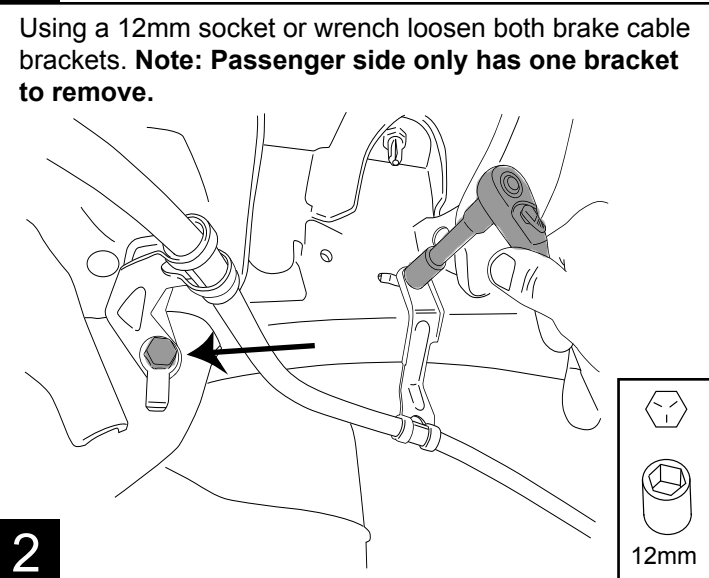
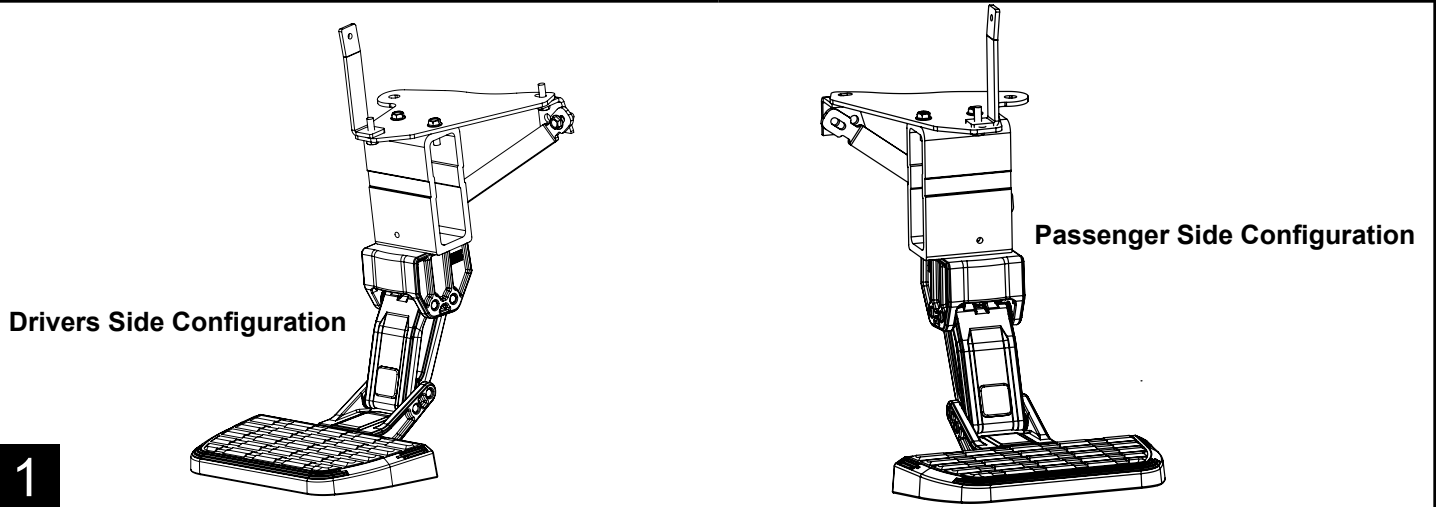
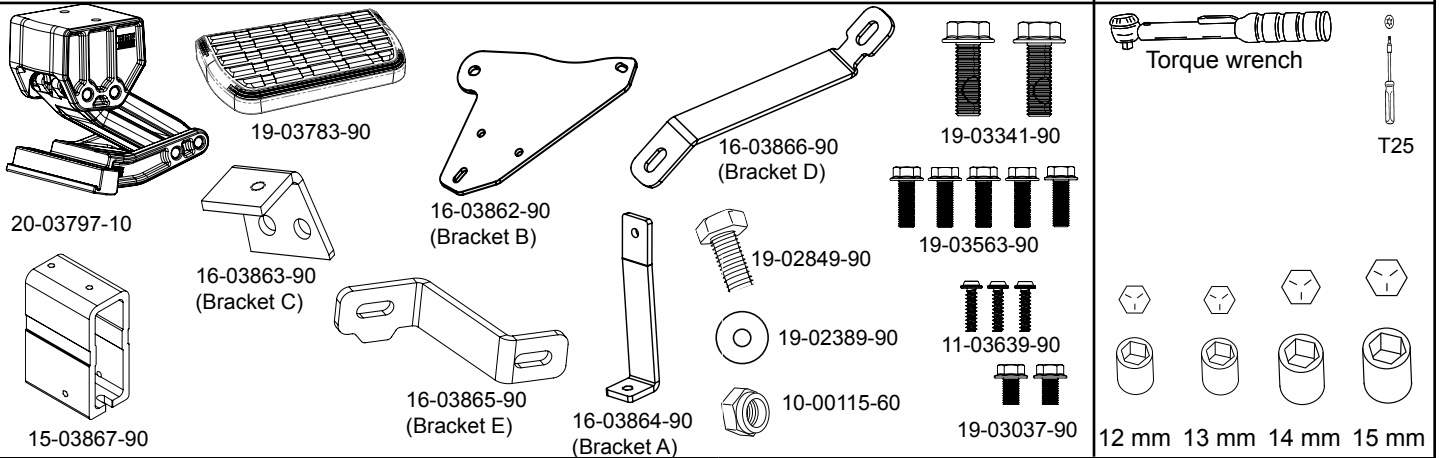

AMP RESEARCH TECH SUPPORT 1-888-983-2204 (Press 2) Monday - Friday, 6:00 AM - 5:00 PM PST

BedStep2™ is invented, designed, engineered and manufactured exclusively by AMP Research and may be covered by one of the following patents: 6,641,158; 6,830,257; 6,938,909; 7,055,839; 7,380,807; 7,398,985; 7,584,975. Made in USA © 2011 AMP Research

Three-year limited warranty. Professional installation is recommended.

(Looking between bed and cab) Using provided hex bolt and fender washer bolt and "Bracket A" to inner bed panel. Do not tighten.



4

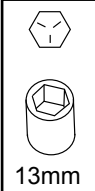

13mm

Reuse body mount bolt from Step 3 with "Bracket B". Do not tighten.

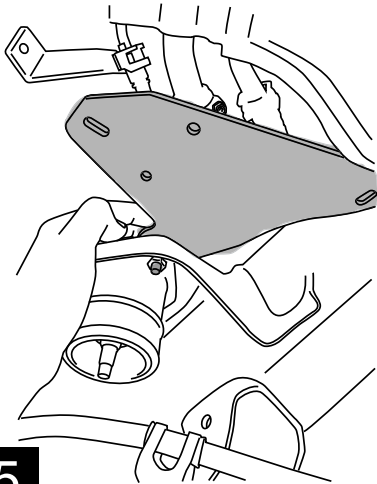

5

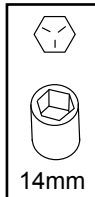

14mm

Using provided flange head bolt slide brake cable bracket onto bolt then "Bracket D" followed by "Bracket C". Do not tighten bolt.

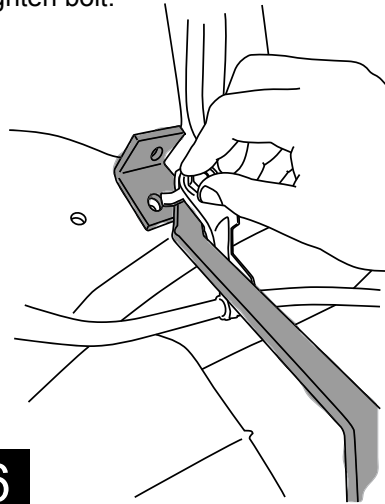

6

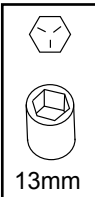

13mm

Using provided shorter flange head bolt tighten "Bracket B" to "Bracket C". Torque bolt to 16 ft-lbs.

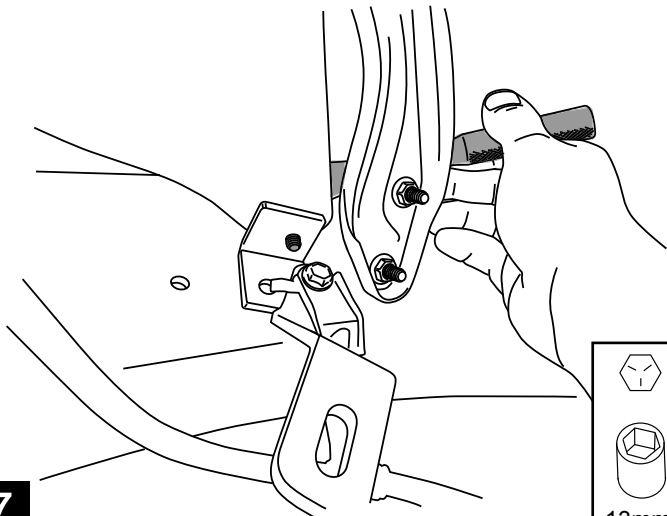

7

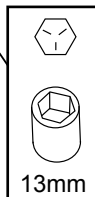

13mm

Use provided shorter flange head bolt and tighten "Bracket A" to "Bracket B". Torque to 16 ft-lbs with 13mm socket. Using a 14mm socket or wrench torque body mount bolt from step 5.

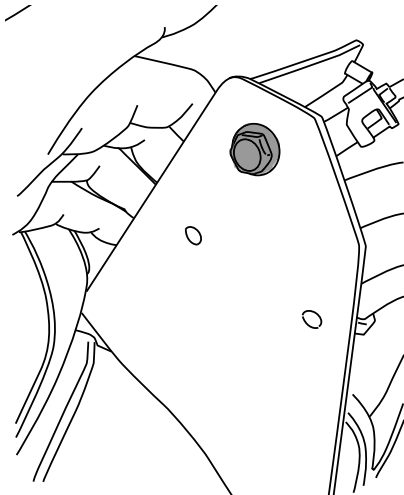

8

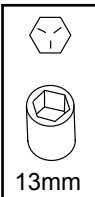

13mm

Using "Bracket E" and provided flange head bolt re attach brake cable bracket. Do not tighten.

Driver Side

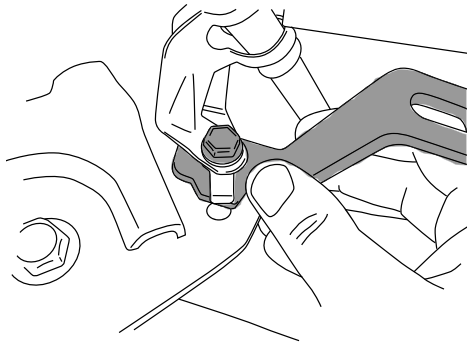

Passenger Side



Note: Passenger side bracket will need supplied nut to tighten bracket into place. Use the upper hole. Do not tighten

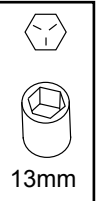

9

Set Flange bolts in through "Bracket B"

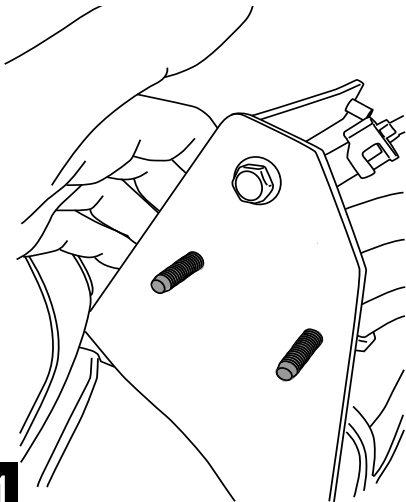

11

Set frame mount into position and tighten two bolts. Torque to 16 ft-lbs. **Note: See step 1 for orientation on passenger side.**

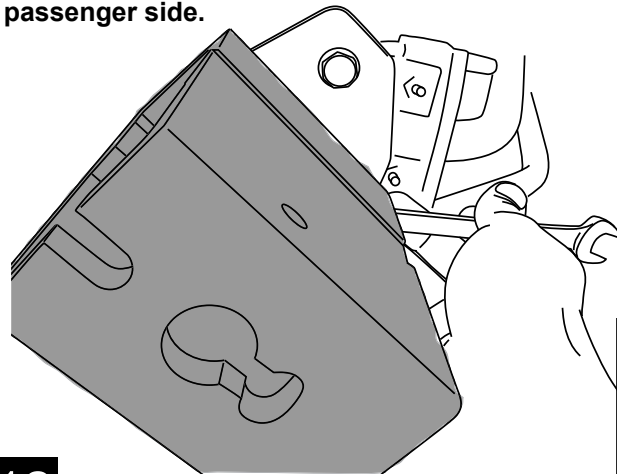

12

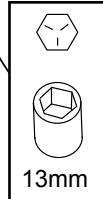

Set "Bracket E" and "Bracket D" together using provided flange head screw tighten bolts. Tighten bolts from Step 6 and 9. Torque to 16ft-lbs.

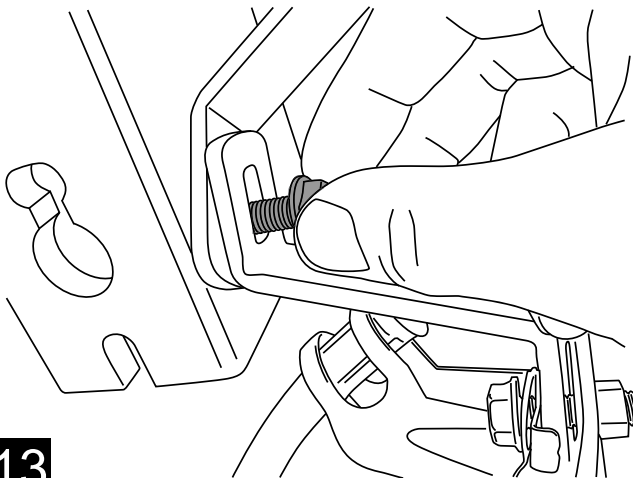

13

Set step pad into center position and tighten screws. Tighten to 5 ft-lbs.



14

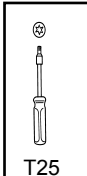

Using 15mm socket or wrench install bolts into linkage assembly. Thread bolts in about half way.

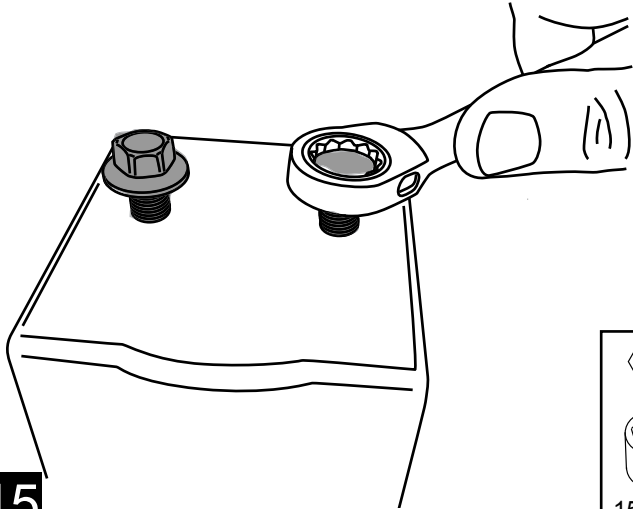

15

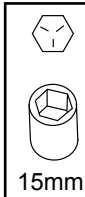

Slide linkage assembly into slot and hole and slide into position.

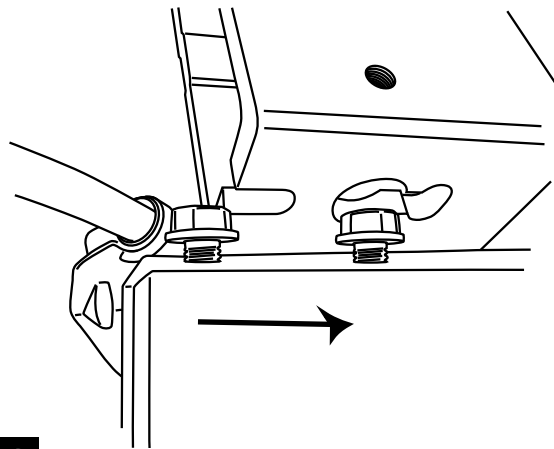

16

Adjust step pad to be in line with body.

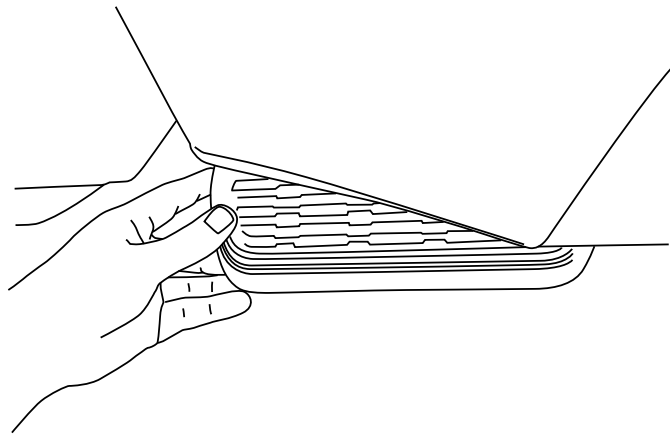

17

Once step pad is in adjusted position tighten bolts. Torque to 20 ft-lbs.



18

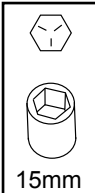



Congratulations on your purchase of the genuine AMP Research BedStep2™. Here's what you should know...

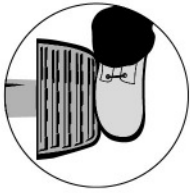

BEDSTEP2™ OPERATION

The AMP Research BedStep2™ is foot operated and deploys and retracts with a nudge of your foot. To deploy, press down using your foot, on the outside edge of the step pad.

Maximum load capacity of the deployed step pad is 300 lbs.

Always use appropriate hand holds when stepping up to or down from your truck's cargo bed.

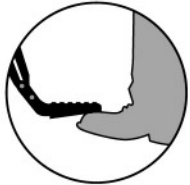

To retract, gently kick up on the underside of the step pad.

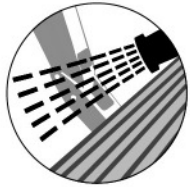

MAINTENANCE TIPS - The stepping surface and linkage should be periodically washed with mild soap and water using a soft brush or sponge to dislodge any mud, dirt or accumulated road grime.

In severe driving conditions, pressure washing the linkage is strongly recommended.

Do not apply silicone spray, waxes or protectants like Armor All® to the stepping surfaces.

CAUTION! BEDSTEP2™ SHOULD ALWAYS BE STOWED IN THE RETRACTED POSITION WHEN DRIVING.

AMP RESEARCH LIMITED WARRANTY

AMP RESEARCH warrants this product to be free from defects in material and workmanship for THREE (3) YEARS FROM DATE OF PURCHASE, provided there has been normal use and proper maintenance. This warranty applies to the original purchaser only. All remedies under this warranty are limited to the repair replacement of the product itself, or the repair or replacement of any component part thereof, found by the factory to be defective within the time period specified. The decision to repair or replace is wholly within the discretion of the manufacturer.

This warranty specifically excludes labor. If you have a warranty claim, first you must call our factory at the number below for instructions. You must retain proof of purchase and submit a copy with any items returned for warranty work. Upon completion of warranty work, if any, we will return the repaired or replaced item or items to you freight prepaid. Damage to our products caused by accidents, fire, vandalism, negligence, misinstallation, misuse, Acts of God, or by defective parts not manufactured by us, is not covered under this warranty.

ANY IMPLIED WARRANTIES OF MERCHANTABILITY AND/OR FITNESS FOR A PARTICULAR PURPOSE CREATED HEREBY ARE LIMITED IN DURATION TO THE SAME DURATION AND SCOPE AS THE EXPRESS WRITTEN WARRANTY. OUR COMPANY SHALL NOT BE LIABLE FOR ANY INCIDENTAL OR CONSEQUENTIAL DAMAGE.

Some states do not allow limitations on how long an implied warranty lasts, or the exclusion or limitation of incidental or consequential damages, so the above limitations or exclusions may not apply to you. This warranty gives you specific legal rights, and you may also have other rights that vary from state to state.

FOR WARRANTY ISSUES WITH THIS PRODUCT PLEASE CALL AMP RESEARCH CUSTOMER SERVICE 1-888-983-2204

WARNING

Be sure to read and precisely follow the provided instructions when installing this product. Failure to do so could place the vehicle occupants in a potentially dangerous situation. After installing or reinstalling, re-check to insure that the product is properly installed.