

**banks**

with Installation Instructions  
**Owner's Manual**

# **Banks Ram-Air® Intake System**

**1999-2008 Chevy/GMC 4.8L, 5.3L, 6.0L V-8 Gas  
Pickups & SUVs**

THIS MANUAL IS FOR USE WITH KIT 41800, 41801, 41802

Gale Banks Engineering  
546 Duggan Avenue • Azusa, CA 91702  
(626) 969-9600 • Fax (626) 334-1743

Product Information & Sales: (888) 635-4565

**bankspower.com**

# General Installation Practices

Dear Customer,

If you have any questions concerning the installation of your Banks Ram-Air System, please call our Technical Service Hotline at (888) 839-2700 between 7:00 am and 5:00 p.m. (PT.). If you have any questions relating to shipping or billing, please contact our Customer Service Department at (888) 839-5600.

Thank you.

1. For ease of installation of your Banks Ram-Air Intake System, familiarize yourself with the procedure by reading the entire manual before starting work. This manual contains 16 pages of copy, illustrations and parts listing. If any pages are missing from this manual please call Gale Banks Engineering immediately for a replacement.
2. The exploded view of the Ram-Air assembly (pages 4-5) provides only general guidance. Refer to each step and section diagram in this manual for proper instruction.
3. Throughout this manual, the left side of the vehicle refers to the driver's side, and the right-side to the passenger's side.
4. Disconnect the negative ground cable from the battery before beginning work. If there are two batteries, disconnect both.

5. Route and tie wires and hoses a minimum of 6 inches away from exhaust heat, moving parts and sharp edges. Clearance of 8 inches or more is recommended where possible.
6. During installation, keep the work area clean. If foreign debris is transferred to any Banks system component, clean it thoroughly before installing.
7. When raising the vehicle, support it on properly weight-rated safety stands, ramps or a commercial hoist. Follow the manufacturer's safety precautions. Take care to balance the vehicle to prevent it from slipping or falling. When using ramps, be sure the front wheels are centered squarely on the topsides; put the transmission in park; set the parking brake; and place blocks behind the rear wheels.

**CAUTION! DO NOT USE FLOOR JACKS TO SUPPORT THE VEHICLE WHILE WORKING UNDER IT. DO NOT RAISE THE VEHICLE ONTO CONCRETE BLOCKS, MASONRY OR ANY OTHER ITEM NOT INTENDED SPECIFICALLY FOR THIS USE.**

## Notification

**The Banks Ram-Air Filter comes pre-oiled and no oiling is necessary for initial installation. Service the filter as specified in the Filter Maintenance Section of this manual.**

## Tools Required:

- 1/4" or 3/8" drive ratchets with metric sockets
- Standard and Phillips head screwdrivers
- Clean shop towels or rags
- 5/16" nut driver

## Table of Contents

<b>Section 1</b> .....	<b>4</b>
General Assembly	
<b>Section 2</b> .....	<b>6</b>
Ram-Air Installation	
<b>Section 3</b> .....	<b>13</b>
Filter Maintenance	

# Section 1

## General Assembly



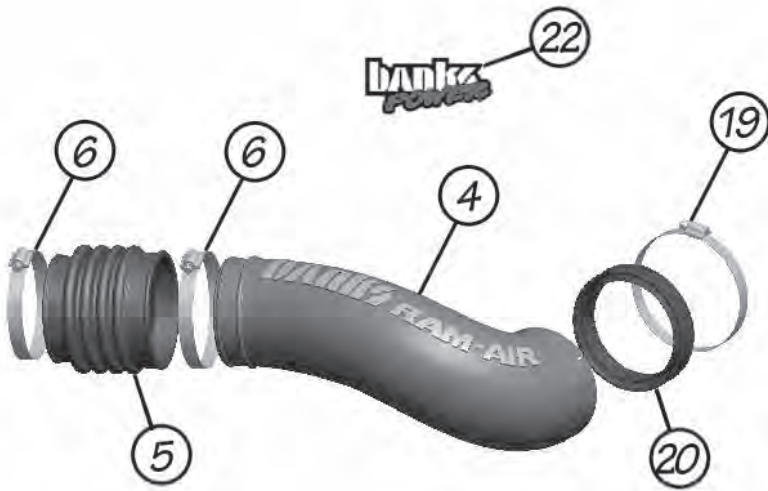

Item	Description	Part#	Qty
1	FILTER HOUSING, Ram-Air	42136	1
2	FILTER HOUSING COVER, Ram-Air	41803	1
3	AIR FILTER ELEMENT	42138	1
4	INTAKE TUBE, RAM-AIR	41804	1
4A*	INTAKE TUBE, RAM-AIR (NOT SHOWN)	41805	1
5	HOSE, BELLOWS	94304	1
6	HOSE CLAMP, #64	92864	2
7	HOSE CLAMP, #128	92928	1
8*	SPRING BAND CLAMP, 5/8" (NOT SHOWN)	92891	1
9	SCREW, #4 TRUSS HEAD, PHILLIPS, 5/16-18 X 3/4"	91226	2
10	SCREW, #4 TRUSS HEAD, PHILLIPS, 5/16-18 X 1 1/4", SS	91242	2
11*	PCV PLUG (NOT SHOWN)	92445	1
12*	PCV HOSE, 3/8" (NOT SHOWN)	94136	1
13	FILTER MINDER PLUG (NOT SHOWN)	92440	1
14	STOCK FILTER MINDER RUBBER GROMMET	/	1
15	STOCK FILTER MINDER	/	1
16	STOCK SEAL GASKET, INLET	/	1
17	STOCK HOSE CLAMP, INLET	/	1
18	STOCK MASS AIR FLOW SENSOR	/	1
19	HOSE CLAMP, THROTTLE BODY	92872	1
20**	SEAL GASKET, THROTTLE BODY	93075	1
21	STOP DO NOT DISCARD, DECAL (NOT SHOWN)	96002	1
22	BANKS POWER UROCAL	96009	2

\* For use with kit 41802. Truck models with electric fans.

\*\* For use with kit 41801 & 41802.

## Section 2

### RAM-AIR INSTALLATION

Use the Bill of Materials Chart and the General Assembly Drawing to reference component nomenclature and location. Use caution when working in the engine compartment. Make sure the engine has been OFF for several hours and cool.

You are about to install the Banks Ram-Air Intake System. Read and follow all steps before working on the vehicle. Some components from the stock air intake system will remain in service. Take care when removing stock air intake components to not damage them.

The images are for general reference only. Your vehicle application may look different.

- 1.** Remove the cover on top of the engine to gain access to the throttle body. Remove the fastener in the center and remove the cover. See **Figure 1**.
- 2.** Loosen the clamp at the inlet of the throttle body and separate the stock

intake tube connecting to the throttle body as shown in **Figure 2**.

- 3.** Loosen the clamp at the inlet of the bellow hose and remove the factory intake tube and bellow hose from the Mass Air Flow (MAF) sensor. See **Figure 3**.

*Note: For truck models with a Positive Crankcase Ventilation (PCV) hose, disconnect and remove the hose from the intake tube.*

- 4.** Disconnect the MAF sensor connector wire harness. Secure the wire harness away from the air box.
- 5.** Remove the stock air box by lifting the air box up and out. The bottom of the stock air box is held in place by rubber grommets. There may be some slight resistance when removing the stock air box.

**Figure 1**

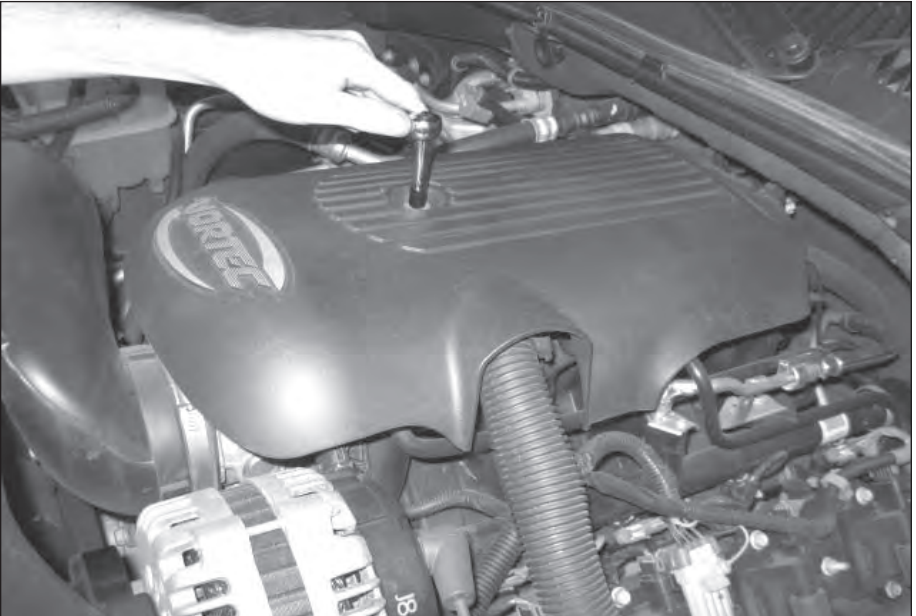

**Figure 2**

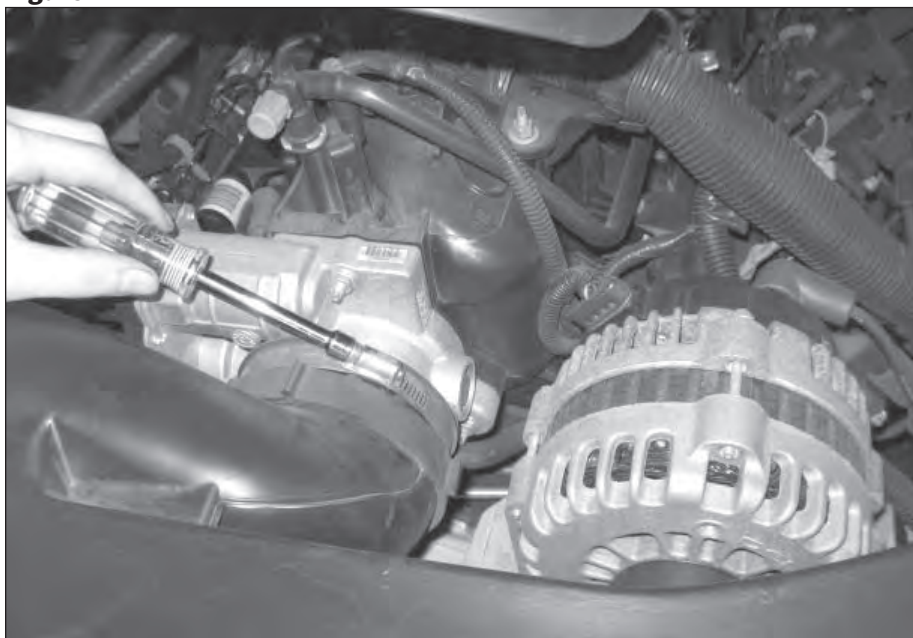

**Figure 3**



**Figure 4**

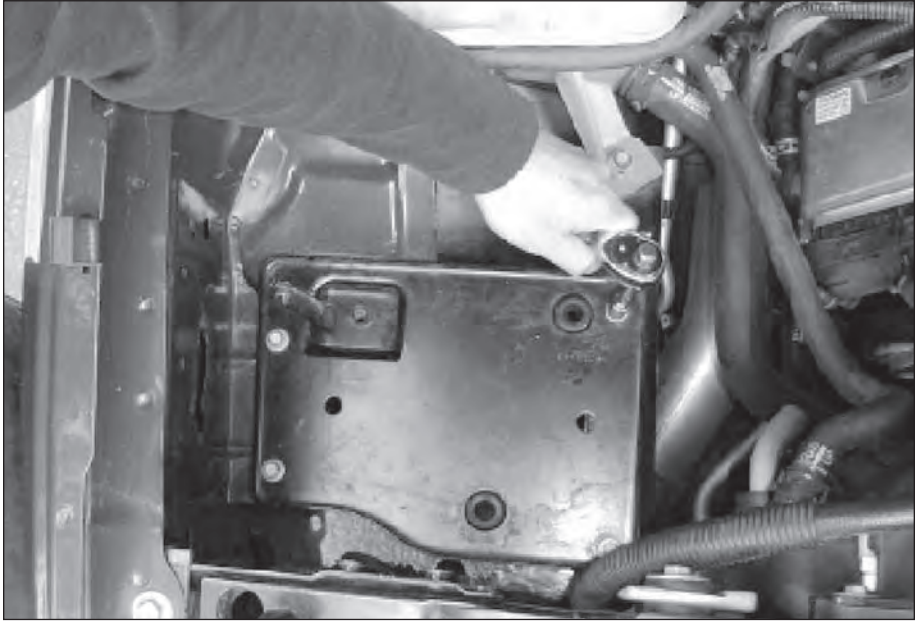

**Figure 5**

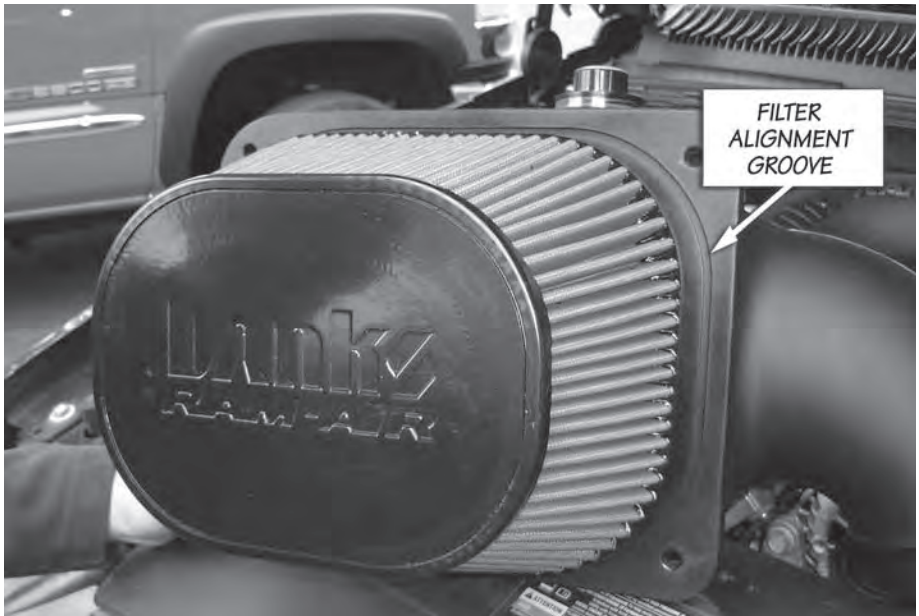



**6.** From the stock air box, remove the stock air Filter Minder. Make sure to remove the stock air filter Minder's rubber grommet as well.

**7.** Next, remove the stock air box tray. Remove the bolts accessible from the top of the engine compartment as shown then remove the stock air box tray. See **Figure 4** . Keep the previously removed bolts for reassembly later in the installation process.

**8.** Locate your Banks Ram-Air Filter Housing from you kit. Align the Banks Ram-Air Filter Housing to fit parallel to fender edge. Install and tighten the previously removed bolts to secure the Banks Ram-Air Filter Housing.

*Note: It may be necessary to adjust the radiator to overflow bottle hose to provide clearance for the Banks Filter Cover Housing. Adjust any other wires or hose as needed.*

**9.** Locate the Banks Ram-Air Filter Housing Cover.

**For vehicle models without a Stock Filter Minder,**

Install the supplied Filter Minder Plug over the filter minder opening on the Banks Ram-Air cover.

**For all truck models with a stock Filter Minder,**

Install the stock air filter Minder's rubber grommet into the Banks Ram-Air Filter Housing Cover. Once the rubber grommet is installed flush into the Banks Ram-Air Cover, then the filter Minder can be inserted into the rubber grommet. Make sure the air filter Minder is installed flush to the rubber grommet.

**10.** Locate the Banks Ram-Air Filter Element and filter hose clamp. Install the filter hose clamp on the filter.

**Figure 6**

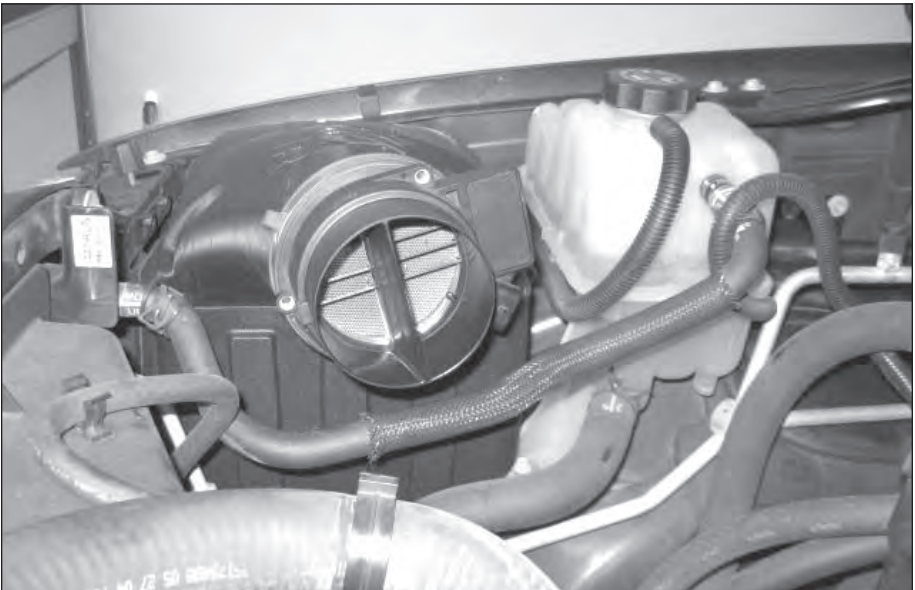

**Figure 7**

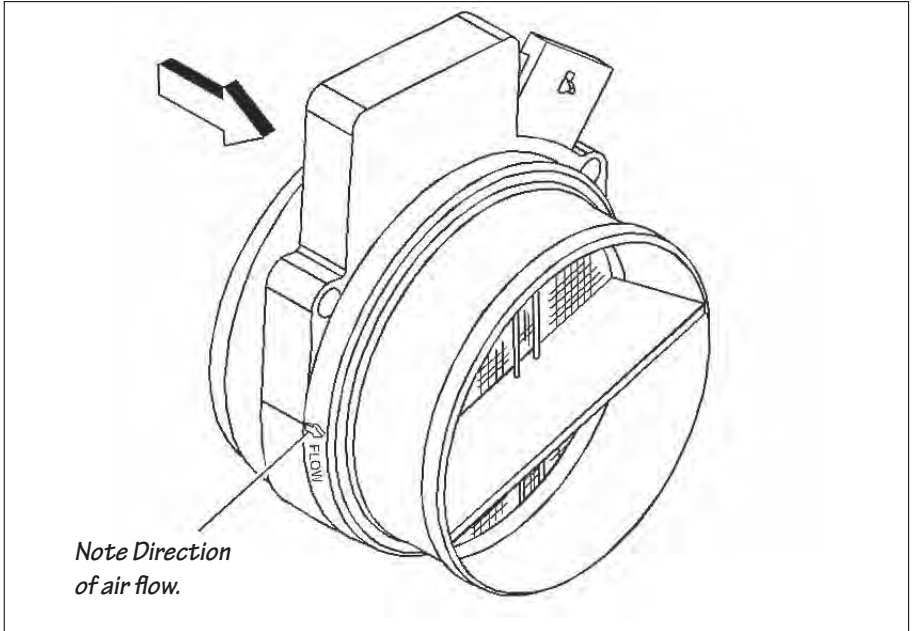

**11.** Install the Banks Filter onto the Banks Ram-Air Filter Cover. Press fit the two pieces together until an audible snap is heard. This process will ensure that a correct seal has been established. Tighten Banks Filter hose clamp.

*Note: see **Figure 5** to reference the correct alignment groove to the Banks Ram-Air filter.*

**12.** Place the Banks Ram-Air filter cover onto the Banks Ram-Air housing. Align and loosely fit the cover onto the housing using the supplied fasteners.

**13.** From the stock air box, remove the MAF sensor by loosening the clamp at the outlet of the stock air box.

*Note: the factory inlet seal gasket and clamp connecting the MAF sensor to the factory air box will be reused.*

**CAUTION: DO NOT TOUCH OR ALLOW ANY SOLVENTS TO ENTER THE SENSING ELEMENT OR DAMAGE MAY RESULT.**

**14.** Install the MAF sensor onto the outlet of the Ram-Air Cover outlet. Use the previously removed factory inlet gasket and hose clamp to secure the sensor to the Ram-Air Cover. Rotate the sensor so that the sensor connection is position as shown in **Figure 6** to provide adequate hood clearance. Tighten the clamp.

*Note: When installing the MAF sensor note the direction of air flow indicated on the side of the sensor. See **Figure 7**.*

**15.** Locate the Banks Ram-Air Intake tube and supplied throttle body seal gasket with hose clamp. Slide rubber grommet and hose clamp over the outlet of the intake tube.

**16.** Install the Banks Ram-Air Intake tube onto the throttle body. Do not tighten the clamp at this time.

**17. For truck models with No PCV hose.**

locate the supplied PCV plug and install over the PCV outlet in the intake tube. Secure the plug using the supplied spring band clamp.

**For all other truck models with a PCV hose connection,**

Locate the supplied PCV hose and spring band clamp. Slide the spring

band clamp over the PCV hose and install the PCV hose over the PCV outlet on the Banks Intake tube. Slide the clamp to secure the hose to the PCV outlet on the Banks Intake Tube. Install the outlet of the Banks PCV hose into the Valve Cover. See **Figure 8.**

**18.** Align the intake tube to the outlet of the MAF sensor outlet. See **Figure 9.**

**19.** Install, but do not tighten, the Banks bellows hose and hose clamp onto the MAF sensor outlet and intake tube inlet. Make sure that the bellow hose is inserted properly into the MAF sensor outlet and the Banks intake tube and tighten the hose clamps.

**Figure 8**

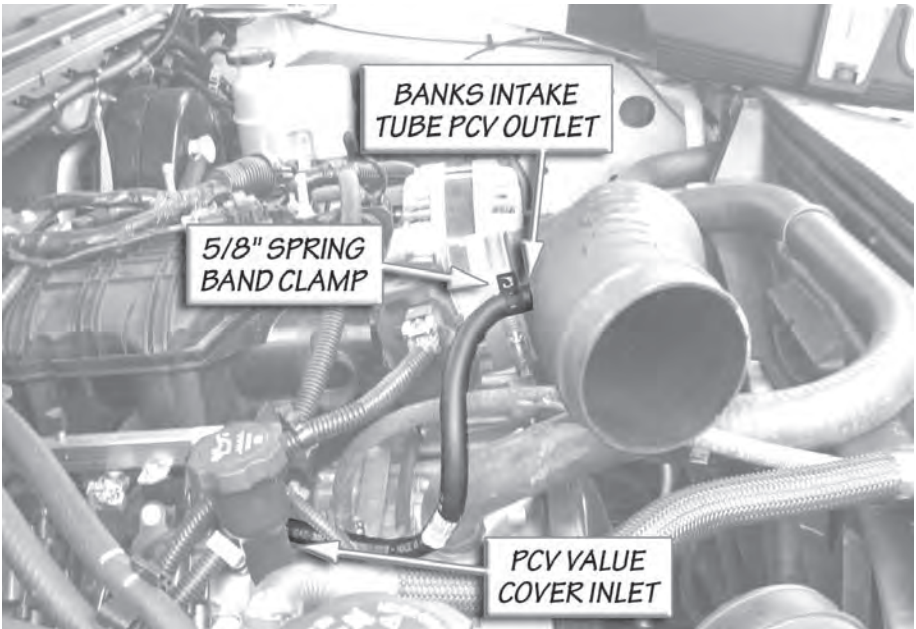

**20.** Re-attach the MAF connector to the MAF sensor.

**21.** Affix the “Do Not Discard” sticker on or near the filter case (included with every Banks replacement element). Make sure you put the sticker in a highly visible place to alert your mechanic not to discard.

**25.** Your system includes two (2) Banks Power decals designed to complement the Chevy emblems on the vehicles front doors.

**22.** Re-install the engine cover with the stock fastener. Make sure to go over all hose clamps for tightness and connectors for a sure fit. Make sure that the intake tube is not touching any engine components. Re-connect battery grounds. You have successfully completed the installation of the Banks Ram-Air Intake system.

**Figure 9**

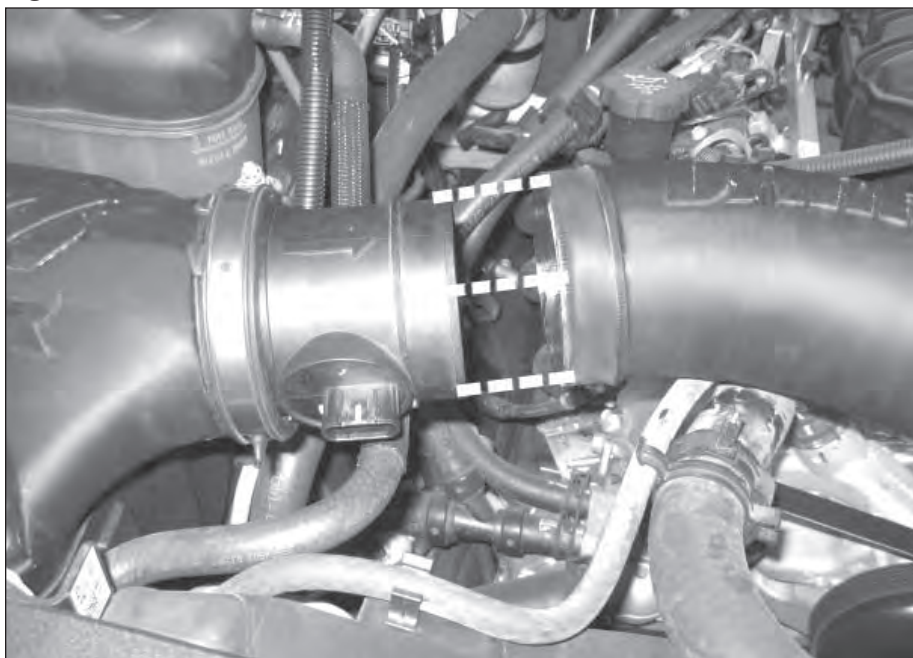

# Section 3

## FILTER MAINTENANCE

### Notification

**The Banks Ram-Air Filter comes pre-oiled and no oiling is necessary for initial installation. Service the filter as specified in this Section of the manual.**

1. Service Banks Ram Air Filter every 50-100,000 miles on street-driven applications. Service more often in off-road or heavy-dust conditions. If an air-filter restriction gauge is installed, then clean the element when the air-filter restriction gauge enters the restrictive red zone. See **Figure 10**.
2. Use Banks Ram Air Filter cleaning system (part # 90094), available from Gale Banks Engineering to service the Air Filter. Follow the instructions included with the cleaning system to clean and re-oil your Banks Ram-Air Filter. No gasoline cleaning, No

steam cleaning, No caustic cleaning solutions, No strong detergents, No high pressure car wash, No parts cleaning solvents. Any of these No's can cause harm to the cotton filter media plus SHRINK and HARDEN the rubber end caps.

**CAUTION! Extremely fine dust from agriculture or off-road use will pull the oil from the element. Frequent re-oiling of the element's clean side might be required. Completely service when practicable. For extra protection use an air-filter sealing grease on rubber ends of the element. Service only with Banks Ram-Air filter cleaner and Banks Ram-Air filter oil.**

**Figure 10** Typical air-filter restriction gauge

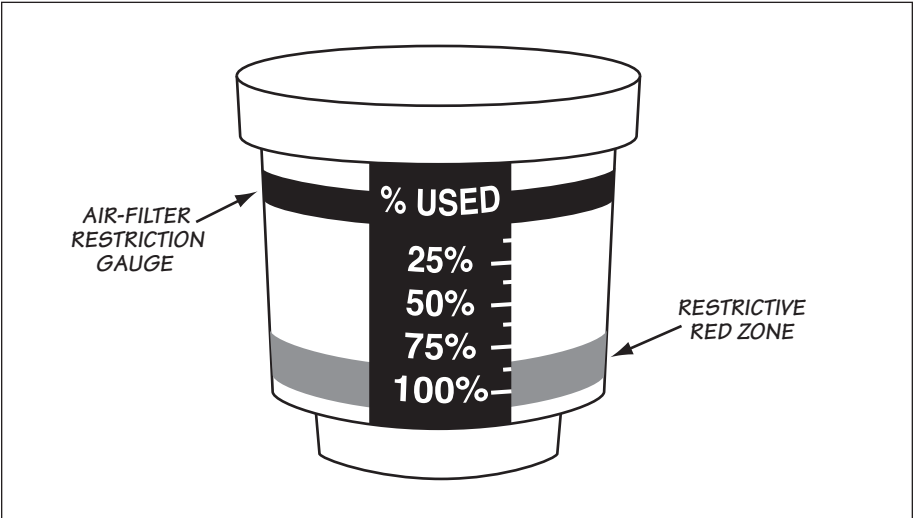

Gale Banks Engineering  
546 Duggan Avenue • Azusa, CA 91702  
(626) 969-9600 • Fax (626) 334-1743

Product Information & Sales: (888) 635-4565

**bankspower.com**