

Chevrolet SmoothBack® Ultimate BedRail Caps

Set Part # 48519

Rev-1 5/14/2014

For complete fitment info visit: www.bushwacker.com

STEP 1 – PRIOR TO INSTALLATION

A) Overview: Bushwacker only approves installing the BedRail Caps according to these written instructions with the hardware provided. **WARNING:** Failure to install according to these instructions will invalidate the warranty. This includes, but is not limited to using alternative installation methods, hardware, or materials. **DO NOT USE:** Loctite®, Super Glue®, or similar products on the BedRail Caps.

B) Fit: Verify the fit of the BedRail Caps to vehicle. *Note: Trimming or modifications to the BedRail Caps may be necessary for use with some Truck Bed Covers or Truck Caps.*

C) Preparing the Work Area: Clean the area of installation with a cloth and rubbing alcohol or prep-solvent to remove any car wax or dirt from vehicle surface.

D) Installation Temperature: During installation on the vehicle, BedRail Caps and tape need to be between 60°F and 110°F for proper adhesion. Failure to maintain proper installation temperature may result in the part not functioning correctly. If not within acceptable range, increase surface temperature using a heat gun or suitable device (hair dryer) to help reach proper range. The warmer the vehicle surface, the better the initial bond, but should not exceed 110°F.

ULTIMATE BEDRAIL & TAILGATE CAPS

TOOLS FOR EASY INSTALLATION:

- Clean Cloth
- Rubbing Alcohol
- #2 Phillips Screwdriver

LIMITED LIFETIME WARRANTY AGAINST ANY MANUFACTURING DEFECTS

- To claim a warranty, you must provide Proof of Purchase.

Included in Hardware Kit:

1.



SW1-0050,
10 x 5/16 Phillips
Truss Screw,
4 pcs

2.



CL1-0006,
Black "S"
Spring Clip,
4 pcs

BedRail Caps Installation Procedures:

STEP 2 – INSTALLATION

- A) Peel the red vinyl backing partially away from tape pads. *Note: Make sure the tabs are folded toward the outside of the part and that the middle tape liner is in front of the outside liner. See Illustration #1.*
- B) Carefully lay the part down on the vehicle bed rail and position properly. **See Illustration #2.**
- C) Maintaining part placement, begin by pulling middle tape tab first. Apply downward pressure to part as you remove tape liner. Remove carefully. Do not break tape liner. Repeat for remaining tape liners. Once all liners are removed, apply firm pressure along all taped areas. *Note: 3M™ recommends 30 PSI to promote full adhesion. Tape reaches maximum adhesive bond after 24 hours of contact.*
- D) Slide a supplied “S” Spring Clip (CL1-0006) onto the vehicle bed rail in the corresponding fastening locations on the inside edge of the BedRail Cap. **See Illustration #3.**
- E) Fasten the BedRail Cap to the clips with the supplied Truss Screws (SW1-0050). **See Illustration #3.**

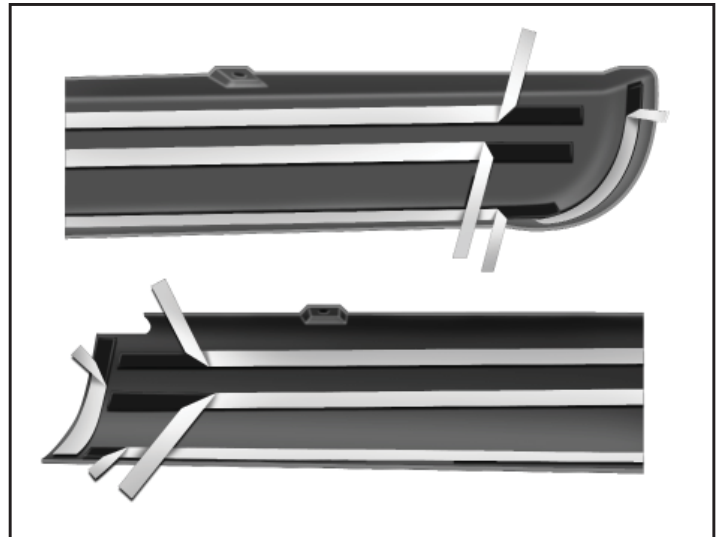

Illustration #1



Illustration #2



Illustration #3