



**BULLY DOG**

**INSTALLATION MANUAL**

**RAPID FLOW**  
*Cold Air Intake*



**Applications**

Ford Power Stroke '11-'15

**RFI Part Number**

51104

Not legal for sale or use in California on pollution-controlled vehicles.



**POWER**



**ECONOMY**



## **TROUBLESHOOTING:**

Technical support is available by calling 1-940-783-9915.

Tech support by phone is available Monday-Friday 8am-5pm Mountain Standard Time.

## **TABLE OF CONTENTS**

<b>INTRODUCTION .....</b>	<b>PG. 1</b>
<b>PARTS INCLUDED .....</b>	<b>PG. 2</b>
<b>PARTS DESCRIPTION .....</b>	<b>PGS. 3-5</b>
<b>INSTALLATION .....</b>	<b>PGS. 6-14</b>
<b>INSTALLATION OVERVIEW.....</b>	<b>PG. 6</b>
<b>REMOVING THE STOCK AIR INTAKE.....</b>	<b>PGS. 7-9</b>
<b>PREPARING TO INSTALL THE RAPID FLOW INTAKE .....</b>	<b>PGS. 10-11</b>
<b>INSTALLING THE RAPID FLOW ON THE VEHICLE .....</b>	<b>PGS. 12-14</b>
<b>FILTER MAINTENANCE .....</b>	<b>PG. 15</b>
<b>PREFILTERS.....</b>	<b>PG. 16</b>

## **INTRODUCTION**

This instruction set outlines the description and installation of the Rapid Flow Cold Air Intake for the Ford 6.7L '11-'15. Installation of this intake takes about 20 minutes and requires only basic tools. This installation can be easily completed using basic tools, mechanical experience is not required.

For additional question or product information visit our website [www.bullydog.com](http://www.bullydog.com) or call Bully Dog technical support at 1-940-783-9915.

## Parts Included and Tools Needed:

This section displays the parts included in the package and the tools needed to properly install the system.

### Parts Included

Rapid Flow Lid .....	Part# 51104-1
Rapid Flow Base.....	Part# 51104-2
Air Filter Tube with MAF Sensor Mount .....	Part# 51104-3
Silicone Coupler .....	Part# 51104-4
Universal Air Intake Latch (4) .....	Part# 5-50000Latch
Air Intake Filter.....	Part# 51106-5
Literature Pack .....	Part# LITPAC
Worm Drive Clamp .....	Part# 51104-7
Black Oxide Phillips Head Screws (2).....	Part# 54100-94
T20 Torx Bit.....	Part# 229120
Flat Nylon Washer .....	Part# 51201-94

### Tools needed

Flat Head Screwdriver  
8mm Socket

Phillips Screwdriver  
Ratchet & Extension

Bit Driver



## **Parts Description:**

This section describes each part and any special features of each part that need to be noted to assist with installation. All parts will be referred to during installation by the names used in this section.

**The RFI base:** The base to the enclosure that holds the filter has a couple of features to note. The first is the circular hole on the back of the base, this hole is where the RFI tube will snap into the base and hold secure the air filter. The second important part of the base to take special notice of are the mounting pegs that are located on the bottom of the filter housing base. The mounting pegs are used to secure the base to the mounting plate within the engine bay.

**The RFI Lid:** The lid is very easy to remove for filter maintenance, be aware that the tongue and groove formed between the housing base and the lid needs to be properly lined up for a good seal. The latch mounts on the lid should always match up



**Air Intake Tube with MAF/Temperature Sensor Mount:** This tube comes with a precisely manufactured mass air flow sensor mount with inset screw mounts. The tube also has a unique interference snap fit feature that will tightly secure the intake tube to the lid.

*RFI base end*

*MAF sensor mount*

*Coolant Hose...*

*Turbo Inlet Side*

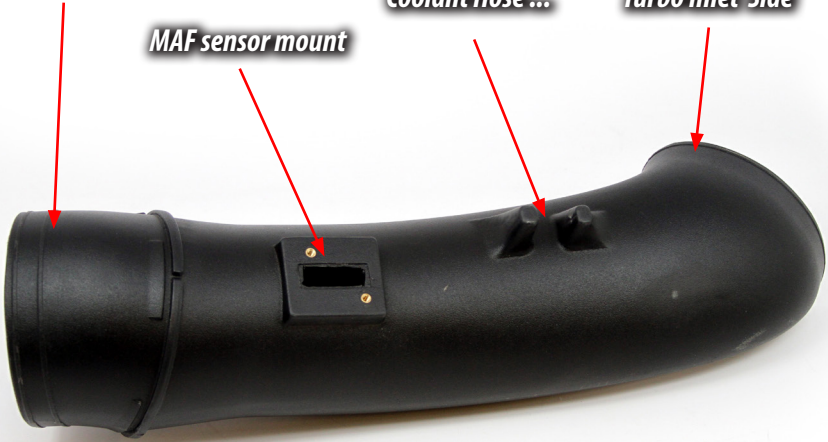

**Silicon Tubing (long and short):** High quality 3 ply silicon tubing.



**Band Clamps:** Connects and holds all tubing in place.

**Stainless Black Oxide Screws & Nylon Washers:** The two Phillips style stainless black oxide screws and Nylon Washers are included with the kit and are used to secure the MAF sensor to the air intake tube.



**Air Filter and Clamp:** The air filter included is an ISO 5011 certified eight layer oil filter. The air filter is secured onto the end of the air intake tube using the filter clamp and a flat-head screwdriver.



**Security Torx Bit:** This bit is included for convenience; the mass air flow sensor is attached to the stock intake tube using security Torx screws. If this bit is lost it can be ordered.



## Installation Overview:

Installation is very simple, it is separated into three parts: Removing the Stock Intake, Preparing the Rapid Flow Cold Air Intake for installation, and Installing the system. The complete installation of the Rapid Flow Cold Air Intake system should total about 20 minutes. The assembly diagram shows how the parts of the intake fit together in sequence.

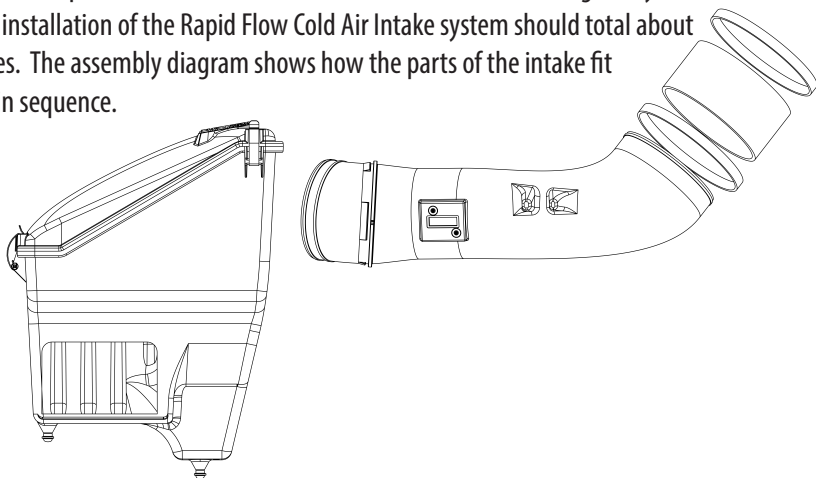

**Stock Intake Overview Diagram:** The stock intake can be seen in the picture below. Notice the important parts of the stock air intake that are labeled in the diagram below. These items are referred to throughout these instructions.

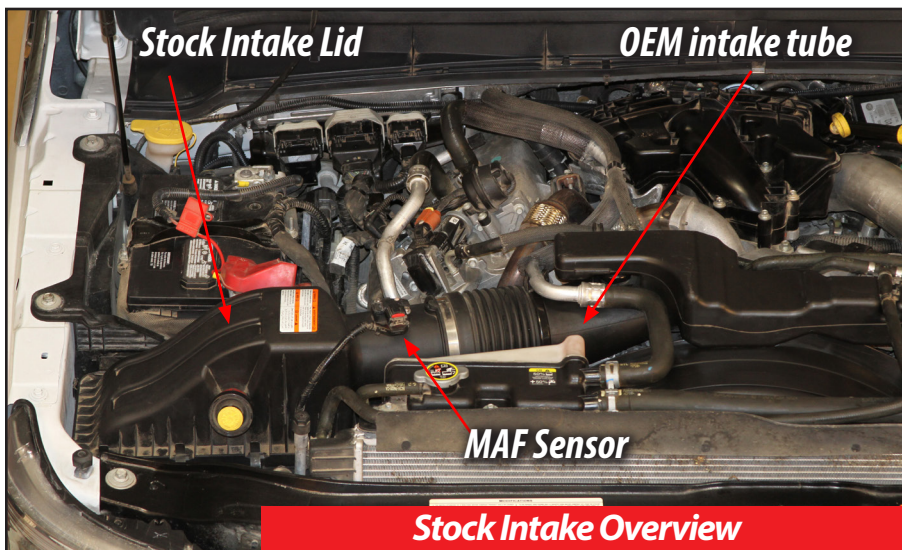

## Removing the Stock Intake:

1. Unplug the Mass Air Flow sensor: to do so properly first pull the red tab located on the bottom side of the sensor outward to release the locking mechanism. Disconnect the sensor plug from the mounted sensor.



2. Disconnect the positive terminal clamp from the battery with an 8mm socket





3. Unscrew and remove bolt from behind the stock intake box with an 8mm socket. An extension will be needed. Set aside bolt for later use.



4. Unscrew and remove bolt from behind the stock intake tube.



5. Loosen both clamps on either end of the stock intake tube. Release lines from stock intake tube and remove.

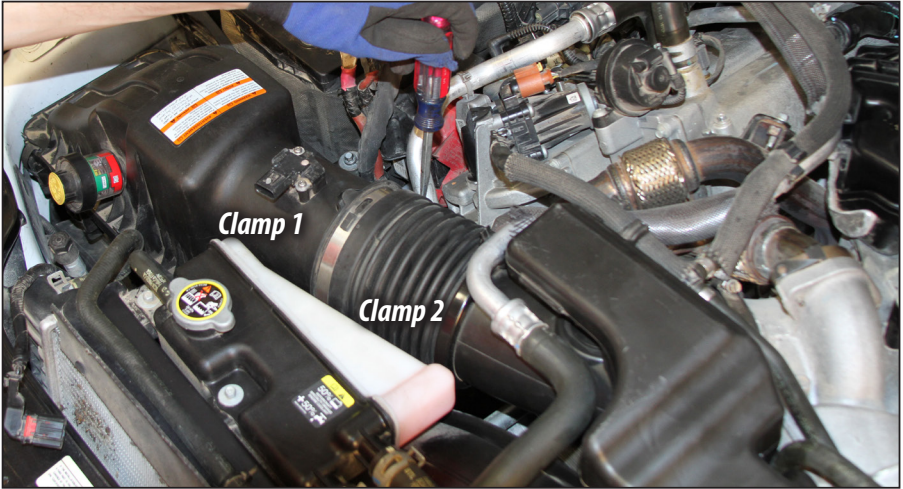

6. Pull straight up to remove stock intake tube and box.



## **Preparing the Intake for Installation:**

The steps in this section will prepare the intake for installation, this section includes steps that are easier to complete with the intake outside of the vehicle.

1. Snap stage 2 tube into bully dog enclosure.



2. Remove grommet assembly from stock intake box and install it on the Bully Dog intake box.



3. Next, remove the stock intake foam gasket and then transfer it onto the Bully Dog intake box.



4. Remove stock intake sensor with t20 security bit and install it on the stage 2 tube with the supplied Phillips screws



5. Slide silicon coupler on the stage 2 tube with both clamps. Slide the silicon coupler so the end is coincident with the end of the tube.

## Intake Installation:

The steps in this section will prepare the intake for installation, this section includes steps that are easier to complete with the intake outside of the vehicle.

1. Install the bully dog box and tube assembly by first guiding the tube under the coolant line then installing the bully dog box into the stock grommets. Place coolant line in the guide on the stage 2 tube.

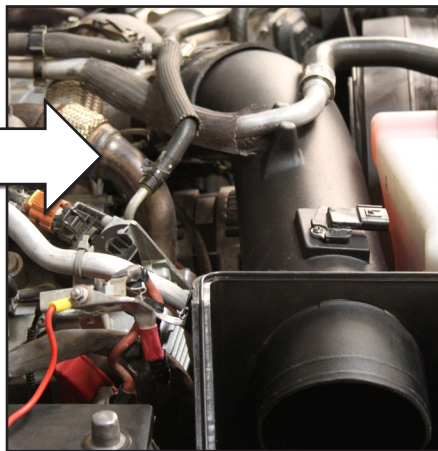

2. After the Bully Dog box is seated properly in the stock grommets secure the box with the stock bolt that held the stock intake in place and then reconnect the positive battery terminal clamp.

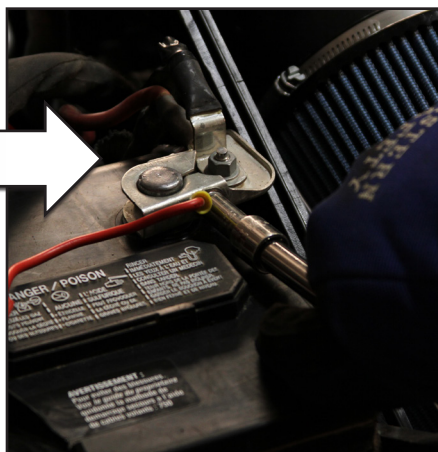
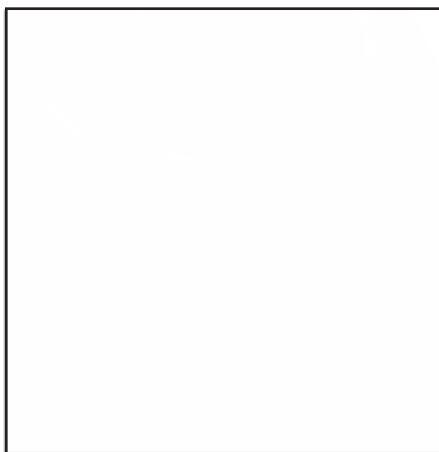

3. Slide the silicon coupler on the stage 2 tube over the turbo inlet. Adjust the tube and coupler for fitment before completely tightening.



4. Install the bully dog filter.

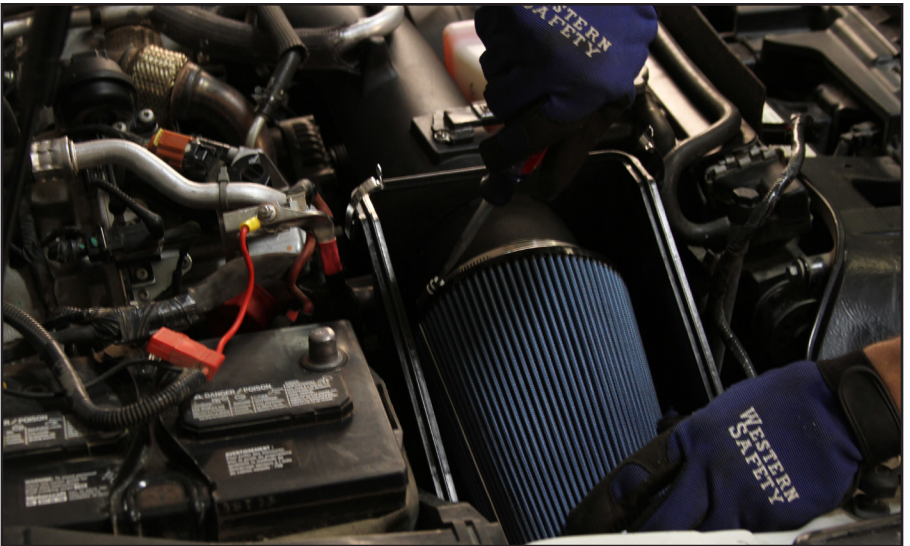

5. Install the lid by latching the lid into place and then reconnect MAF sensor.



## Filter Maintenance:

The intake system should be cleaned at least once every three months; in dusty climates the filter should be cleaned more often. Use a prefilter to extend time between cleaning. Cleaning the intake is a two part process, the first part of the process involves the physical cleaning of the filter with soap and water and the second part involves oiling the filter. To properly clean the filter, a Bully Dog cleaning kit should be used. Cleaning kits are available at any Bully Dog dealer.

### PART 1, CLEANING THE FILTER:

1. Remove filter from filter housing. Clean the filter housing if necessary.
2. Begin the cleaning process by ridding the filter of any dirt by lightly tapping it. Then brush away any loose particles with a soft-bristle brush. This step can usually be avoided with the use of a prefilter.
3. Spray cleaner generously over entire filter and let soak for 10 minutes.
4. Thoroughly rinse the filter with regular tap water (avoid high-pressure hoses). Flush from the inside out or clean side to the dirty side to prevent dirt from entering the filter.
5. Let the filter air dry before oiling, do not use any method to speed up the drying process. Using a blow dryer or compressed air can cause the filter to disfigure which would then allow particles to pass through the filter.



### PART 2, OILING THE FILTER:

1. Apply a small amount of oil to the soft bristle brush and spread the oil over the filter. Be sure to apply a small amount of force so not to damage the filter element.
2. Continue applying oil to the filter using a soft bristle brush until the entire filter is covered in an even amount of oil, just enough to give the filter a solid blue color. Apply enough oil to make the filter a solid and uniform blue, but do not go beyond that.
3. Allow oil to sit for 20 minutes. Re-oil any dry spots that appear. Do not oil filter excessively. Excessive oiling can cause damage to intake sensors.



## ***Bully Dog PreFilter (Part # 51104-8 for your intake)***

The time between scheduled filter maintenance can be extended. Using a prefilter will prevent all large debris from getting into the ribs of the filter. When using the prefilter, only fine dust particles make it through the prefilter and onto the exterior of the filter. Thus when using a prefilter, scheduled cleaning is much easier and filter life is positively effected.

### **AIR FILTER PREFILTER**

- Extend Time Between Cleanings
- Hydrophobic Material Repels Water
- Protects Cone Filter from Large Debris
- Maintains Filter Airflow Between Cleanings



# NOTES

# NOTES

Check out more of our **ADRENALIN PUMPING** products!

Triple Dog GT



Pre Filter



Cleaning Kits



Clothing



GT Diesel is not legal for sale or use in California on pollution-controlled vehicles.



**BULLY DOG**

Free Technical Support at: 1-940-783-9915

See More at: [bullydog.com](http://bullydog.com)