



Equipped with AEM® Dryflow™ Filter
No Oil Required!

INSTALLATION INSTRUCTIONS

PART NUMBER:21-8220

2007 DODGE Nitro V6-4.0L C.A.R.B. E.O. # D-670

* **NOTE:** Legal in California only for racing vehicles which may never be used upon a highway

PARTS LIST

	Description	Qty.	Part Number
A	Air Filter Assy. 3.25 X 9" Dry Ele.	1	21-2109DK
B	Heat Shield	1	20-77070002
C	Inlet Pipe	1	2-77070002
D	Edge Trim, 11"	1	8-4011
E	Edge Trim, 5"	1	8-4005
F	Rubber Edge Trim 7"	1	8-3007
G	1/2" Bnd Hose Clamp, 3.15"-4.00"	1	9456
H	1/2" Bnd. Hose Clamp, 2.90"-3.75"	1	9452
I	Hose, Adapter 3.25/2.75x3" EPDM	1	5-328
J	1/2" Bnd. Hose Clamp, 2.31-3.25"	1	9444
K	Mount, Rubber 1" X 6mm	1	1228599
L	Washer, 6mm Soft Mount	4	08160
M	Nut, M6 Hex Serrated	3	444.460.04
N	Connector, Plastic 1/2" 90 Deg.	1	8-157
O	Grommet, 1/2"	2	784634
P	Nut, 1/4-20 Nylock	1	1-2074
Q	Nut, 1/4-20	1	1-2073
R	Stand, Aluminum	1	2-670
S	Washer, 1/4 SAE Flat	1	1-3028
T	Bolt, Hex 1/4-20 X 1 3/4	1	1-2072

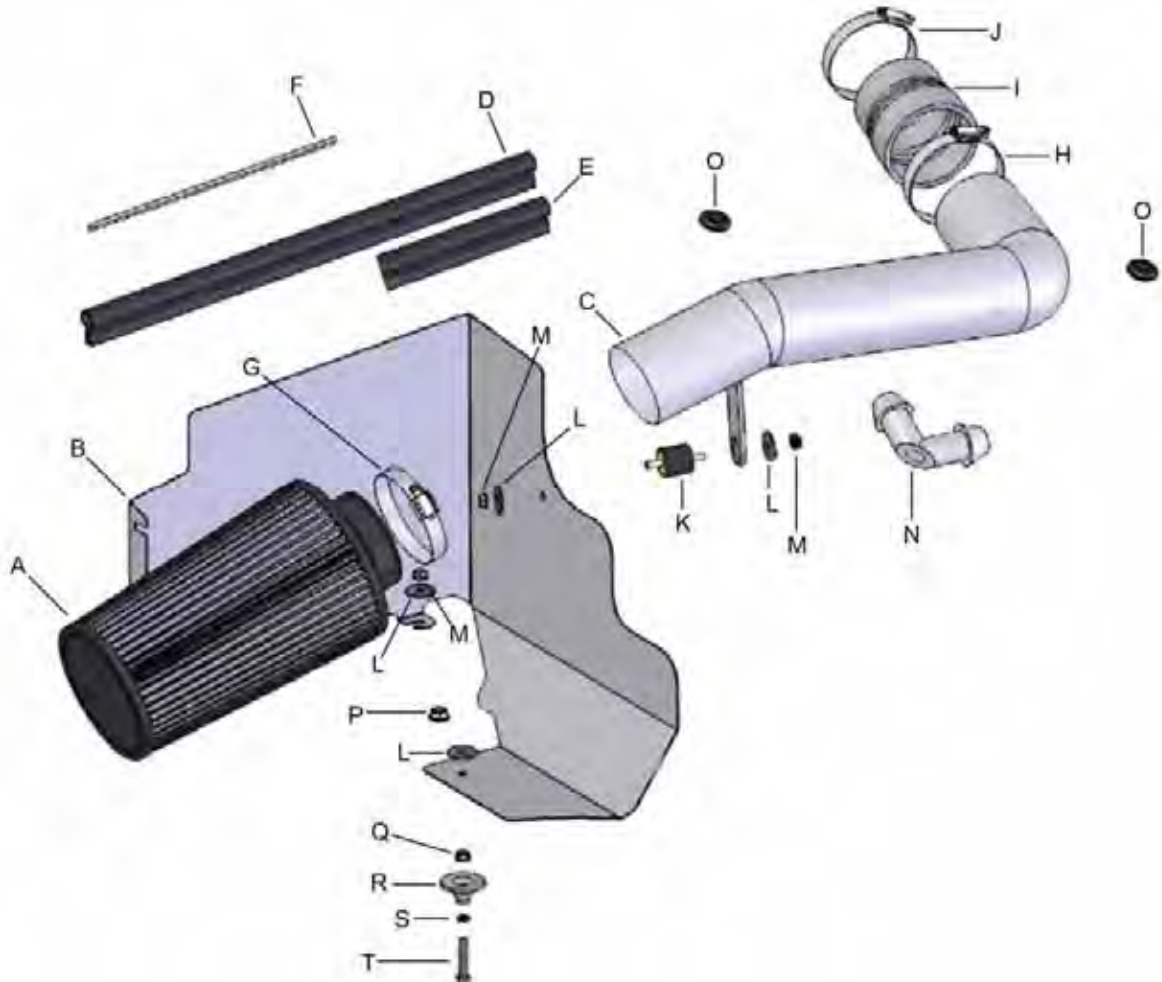

Read and understand these instructions **BEFORE** attempting to install this product. Failure to follow installation instructions and not using the provided hardware may damage the intake tube, throttle body and engine.

1. Preparing Vehicle

- a. Make sure vehicle is parked on level surface.
- b. Set parking brake.
- c. If engine has run in the past two hours, let it cool down.
- d. Disconnect negative battery terminal.
- e. Do not discard stock components after removal of the factory system.

2. Removal of stock system

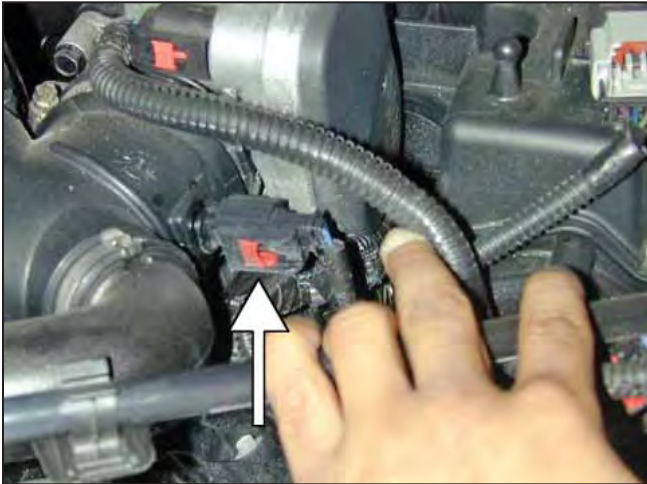

a. Disconnect the Inlet Air Temperature (IAT) sensor connector. Push up the on the release (red) and depress the connector (black).

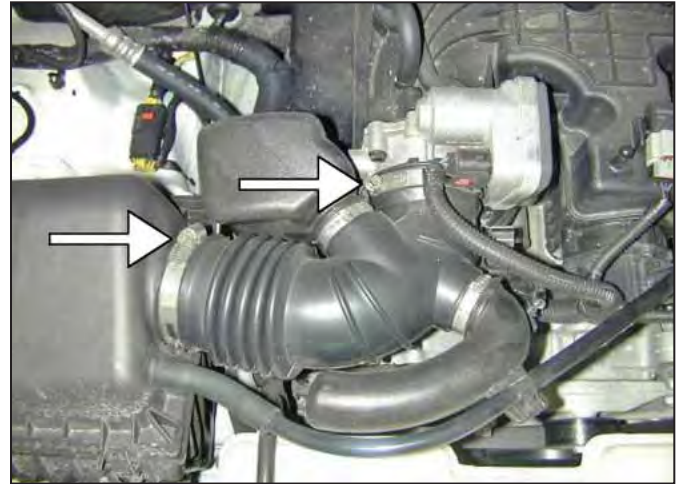

b. Loosen hose clamp at the throttle body and at the air box. Remove air inlet tube.

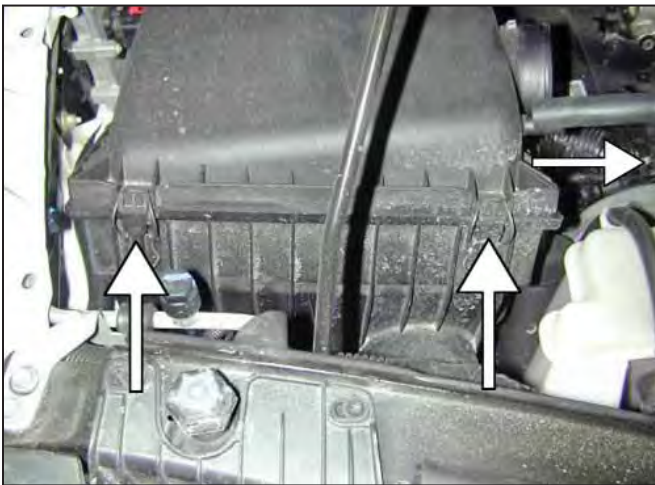

c. Remove the PCV breather tube from the air box. Unclip the air box lid and remove with air filter.

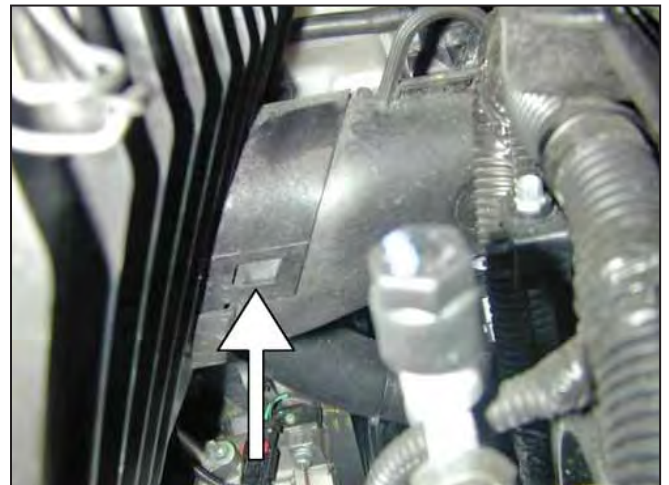

d. Disconnect the lower air box from the fresh air duct by unclipping the connection on both sides of the tube.

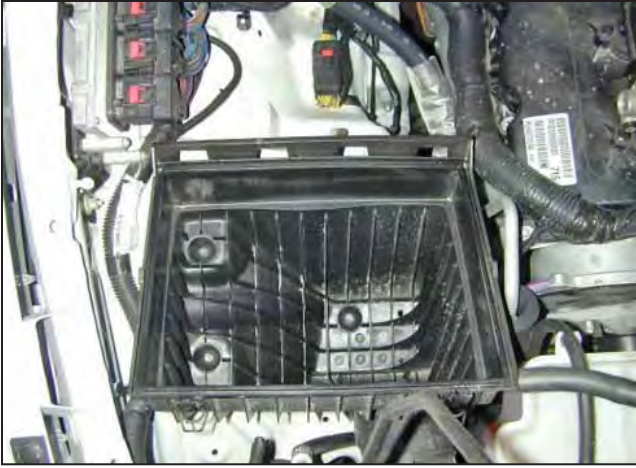

e. Remove the lower section of the air box by pulling straight up.
NOTE: Be careful not to damage the fresh air inlet tube.



f. Remove the push-in tab from the fresh air duct and remove ducting.



g. Loosen and remove the nuts to the ECU mounting bracket. These will be reused later step during the installation process.

3. Installation of AEM® intake system.

a. When installing the intake system, do not completely tighten the hose clamps or mounting hardware until instructed to do so.



b. Insert the 1/4-20 bolt and 1/4" washer from underneath the grommet through the fender well.



c. Install the aluminum stand over the bolt installed in the previous step. Secure the assembly with the 1/4-20 nut and tighten.



d. Insert the heat shield as shown. Align the heat shield with the studs described in step 2(g). The bottom of the heat shield should align with the stud installed during steps 3(b)-3(c).



e. Secure the heat shield with the nuts removed in step 2(g) as shown.



f. Secure the bottom of the heat shield with the fender washer and nylock nut.

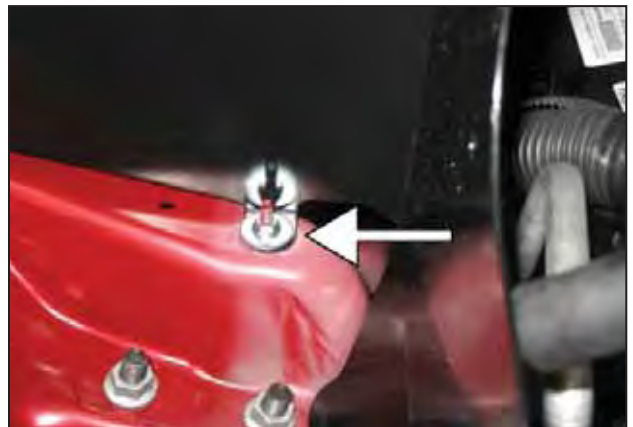

g. Secure the heat shield tab with the fender washer and M6 nut. Check for clearance around the heat shield. Tighten all mounting points.



h. Attach the coupler to the throttle body and secure with #44 (9452) and #52 (9452) hose clamp.

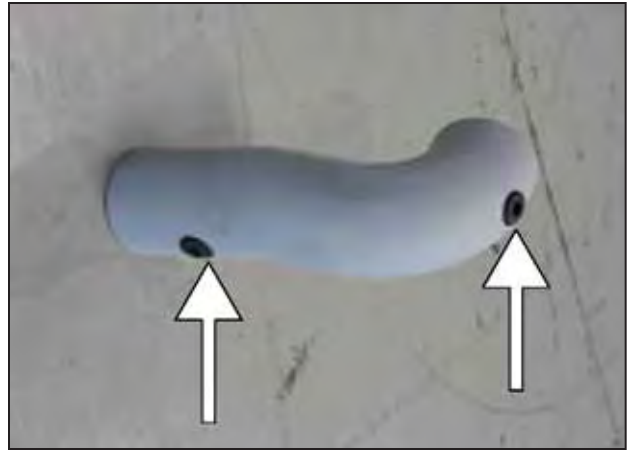

i. Insert both grommets into the pipe. Ensure the grommets are installed properly.

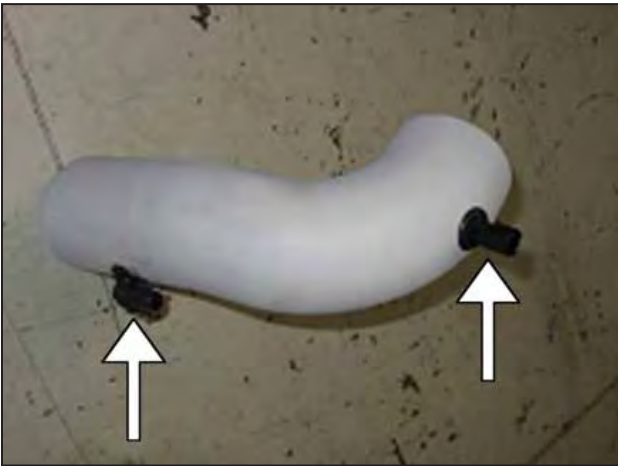

j. Insert the 90 degree fitting into the straight section of the pipe. Insert the IAT sensor into the grommet near the bend.



k. Attach the sponge gasket to the top to the heat shield. Attach the rubber edge trim on the radius.



l. Install the rubber mount, fender washer and M6 nut onto the heat shield.



m. Insert the intake pipe as shown.



n. Align the bracket with the rubber mount. Check for clearance around the heat shield. Secure with a fender washer and M6 nut.



o. Attach the factory breather hose to the nipple.



p. Check and ensure there is clearance around the breather hose around the alternator and connector.



q. Reconnect the IAT sensor harness connector and secure.

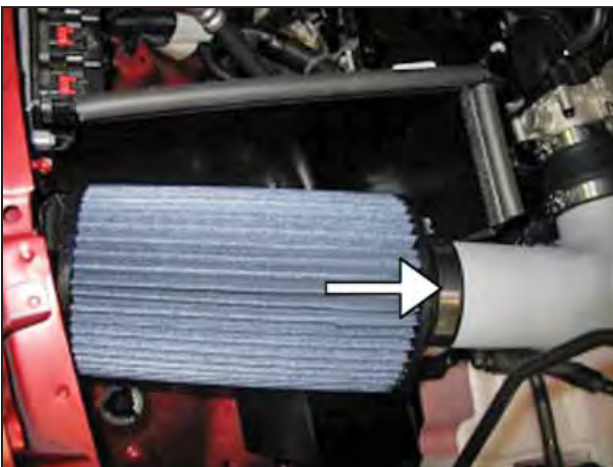

r. Attach the air filter element and secure with the remaining hose clamp (9456).



AEM® intake system installed

4. Reassemble Vehicle

- a. Position the inlet pipes for the best fitment. Be sure that the pipes or any other components do not contact any part of the vehicle. Tighten the rubber mount, all bolts, and hose clamps.
- b. Check for proper hood clearance. Re-adjust pipes if necessary and re-tighten them.
- c. Inspect the engine bay for any loose tools and check that all fasteners that were moved or removed are properly tightened.
- d. Reconnect negative battery terminals and start engine. Let the vehicle idle for 3 minutes. Perform a final inspection before driving the vehicle.

5. CARB Sticker Placement

- a. The C.A.R.B. exemption sticker, (attached), must be visible under the hood so that an emissions inspector can see it when the vehicle is required to be tested for emissions. California requires testing every two years, other states may vary.

6. Service and Maintenance

- a. It is recommended that you service your AEM® Dryflow™ filter every 20,000 miles for optimum performance. Use AEM Dryflow cleaning kit part # 21-110.
- b. Use aluminum polish to clean your polished AEM® intake tube.
- c. Use window cleaner to clean your powder coated AEM® intake tube. **(NOTE: DO NOT USE aluminum polish on powder coated AEM intake tubes).**

For technical inquiries
e-mail us at
sales@aemintakes.com
or
call us at
800.992.3000

AEM Air Intake System Warranty Policy

AEM® warrants that its intake systems will last for the life of your vehicle. AEM will not honor this warranty due to mechanical damage (i.e. improper installation or fitment), damage from misuse, accidents or flying debris. AEM will not warrant its powder coating if the finish has been cleaned with a hydrocarbon-based solvent. The powder coating should only be cleaned with a mild soap and water solution. Proof of purchase of both the vehicle and AEM intake system is required for redemption of a warranty claim.

This warranty is limited to the repair or replacement of the AEM part. In no event shall this warranty exceed the original purchase price of the AEM part nor shall AEM be responsible for special, incidental or consequential damages or cost incurred due to the failure of this product. Warranty claims to AEM must be transportation prepaid and accompanied with dated proof of purchase. This warranty applies only to the original purchaser of product and is nontransferable. Improper use or installation, use for racing, accident, abuse, unauthorized repairs or alterations voids this warranty. AEM disclaims any liability for consequential damages due to breach of any written or implied warranty on all products manufactured by AEM. Warranty returns will only be accepted by AEM when accompanied by a valid Return Merchandise Authorization (RMA) number. Credit for defective products will be issued pending inspection. Product must be received by AEM within 30 days of the date RMA is issued.

If you have a warranty issue, please call (800) 992-3000 and our customer service department will assist you. A proof of purchase is required for all AEM warranty claims.