



LEGAL IN CALIFORNIA ONLY FOR RACING VEHICLES WHICH MAY NEVER BE USED, REGISTERED OR LICENSED FOR USE UPON A HIGHWAY.  
See knfilters.com for CARB status on each part for a specific vehicle

## INSTALLATION INSTRUCTIONS

### 77-9026KP TOYOTA 2005-15 Tacoma L4-2.7L

NOTE: This kit was not designed to fit vehicles with a body lift.

#### TOOLS NEEDED:

9/64" Allen  
2.5mm Allen  
10mm Socket  
12mm Socket  
13mm Socket  
10mm Wrench  
Extension  
Phillips Screwdriver  
Ratchet

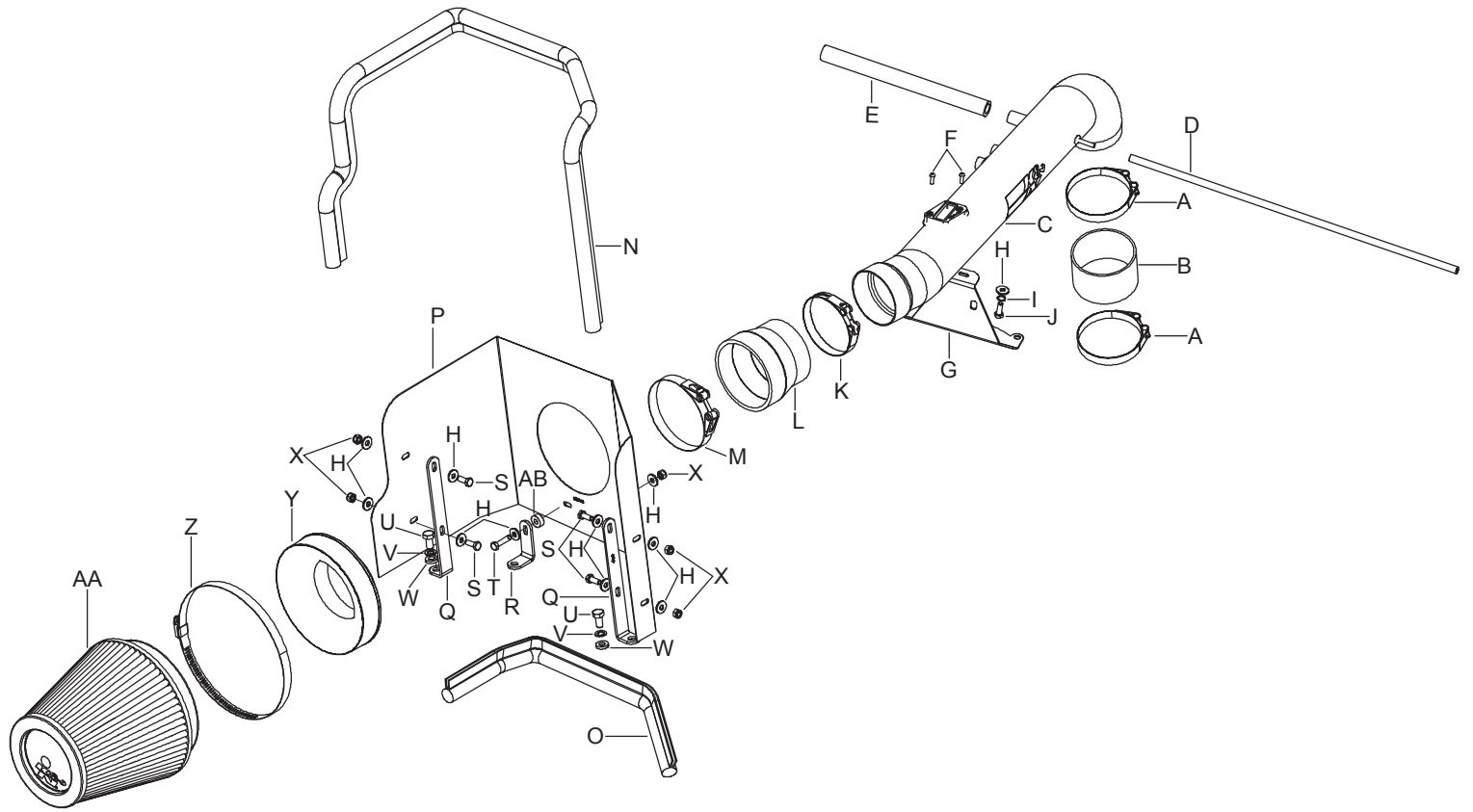

#### PARTS LIST:

Description	Qty.	Part #	Description	Qty.	Part #
A Hose Clamp #40	2	08554	K Hose Clamp #48	1	08601
B Hose; 2.75"ID X 2"L, Black Silicone	1	08440	L Hose; 3.0"ID To 3.5"ID Tprd. Silicone	1	084055
C Intake Tube	1	27358	M Hose Clamp #56	1	08620
D Hose; 4mm X 18"L	1	08153	N Edge Trim 48"	1	102485
E Hose; 1/2"ID X 9"L, Black Silicone	1	08401	O Edge Trim 17"	1	102469
F Bolt; M4-7, B/H/A	2	07793	P Heat Shield	1	074039
G Bracket; Tube Mounting	1	010114	Q Bracket; Lg. "L"	2	07159
H Washer; 1/4"ID X 5/8"OD Flat	11	08275	R Bracket; Sm. "L"	1	070812
I Washer; 1/4" Split Lock	1	08198	S Bolt; 6mm-1.00 X 16mm	4	07703
J Bolt; 6mm-1.00 X 10mm	1	07863	T Bolt; 6mm-1.00 X 25mm	1	07704
			U Bolt; 8mm-1.25 X 16mm	2	07844
			V Washer; 8mm Wave	2	08239
			W Washer; 5/16"ID X 5/8"OD, Flat	2	08276
			X Nut; 6mm Nylock	5	07553
			Y Adapter #380	1	21512-1
			Z Hose Clamp #104	1	08697
			AA Air Filter	1	RF-1042
			AB Spacer	1	06555

**NOTE: FAILURE TO FOLLOW INSTALLATION INSTRUCTIONS AND NOT USING THE PROVIDED HARDWARE MAY DAMAGE THE INTAKE TUBE, THROTTLE BODY AND ENGINE.**

#### TO START:

1. Turn off the ignition and disconnect the negative battery cable.

**NOTE: Disconnecting the negative battery cable erases pre-programmed electronic memories. Write down all memory settings before disconnecting the negative battery cable. Some radios will require an anti-theft code to be entered after the battery is reconnected. The anti-theft code is typically supplied with your owner's manual. In the event your vehicles' anti-theft code cannot be recovered, contact an authorized dealership to obtain your vehicles anti-theft code.**



2. Disconnect the mass air sensor electrical connection and unclip the three wire harness retaining clips from the intake plenum.

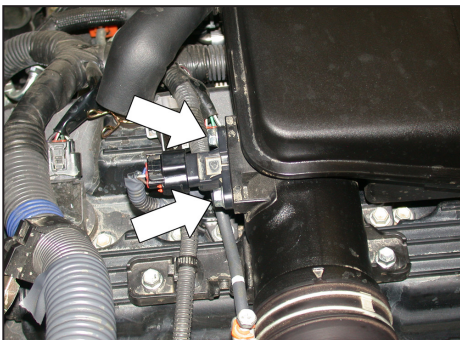

3. Remove the two bolts that secure the pressure sensor to the stock intake tube.  
**NOTE: These bolts will be reused in a later step.**

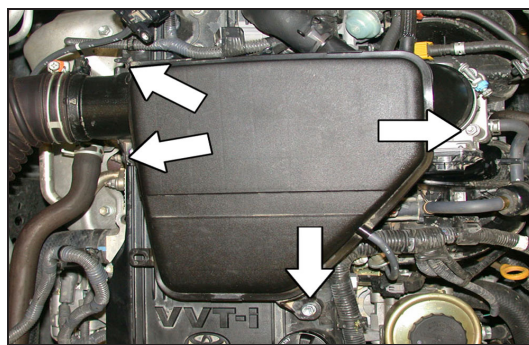

4. Remove the three bolts that secure the intake plenum to the engine and loosen the throttle body hose clamp.



5. Unlatch the upper air box retaining clips, disconnect the fuel pressure regulator and crank case vent hoses and then lift the intake tract off of the throttle body as shown.



6. Disconnect the wire harness-retaining clip shown from the intake plenum.

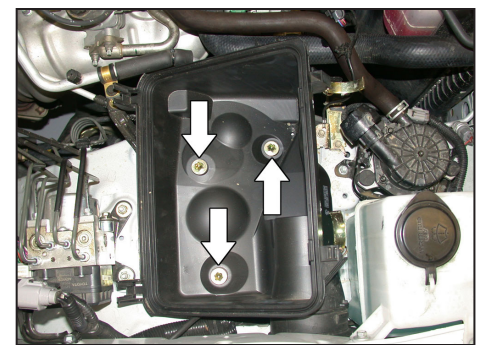

7. Remove the three lower air box retaining bolts shown and then remove the lower air box from the vehicle.

**NOTE: K&N Engineering, Inc., recommends that customers do not discard factory air intake.**

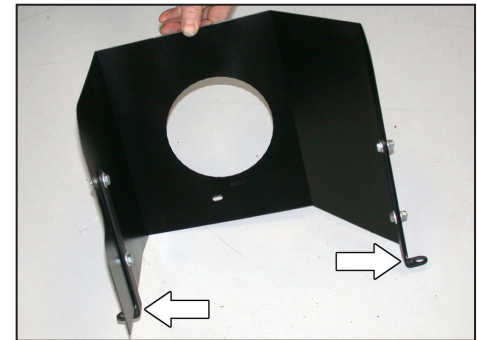

8. Install the two heat shield brackets (07159) onto the heat shield as shown with the provided hardware.



9. Install the small heat shield mounting bracket (070812) with the provided spacer onto the heat shield as shown.

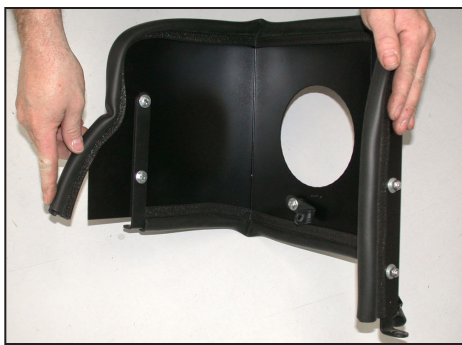

10. Install the provided edge trim onto the heat shield as shown.

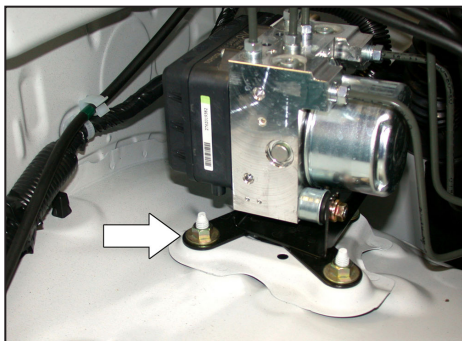

11. Remove the ABS pump mounting nut shown.  
**NOTE: This nut will be reused.**

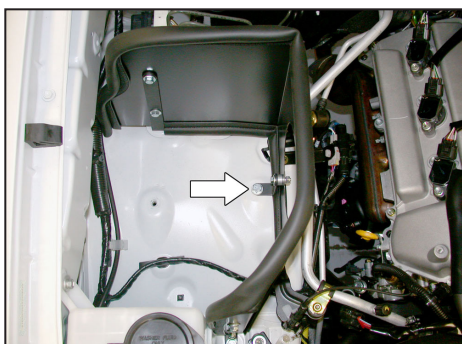

12. Install the heat shield onto the vehicle and secure with the provided hardware and the nut removed in step #11.

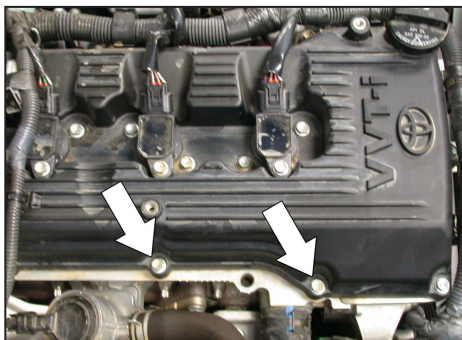

13. Remove the two valve cover bolts shown.  
**NOTE: These bolts will be reused.**

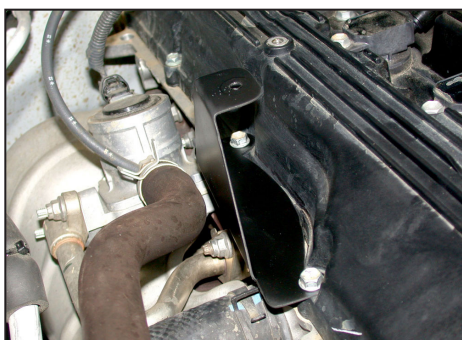

14. Install the tube mounting bracket assembly onto the valve cover using the factory bolts removed in step #13.



15. Install the provided silicone hose (08440) onto the throttle body and secure with the provided hose clamp.



16. Remove the two mass air sensor retaining screws and then remove the mass air sensor from the factory air box.



17. Install the mass air sensor into the K&N® intake tube and secure with the provided M4 button head allen bolts as shown.



18. Install the K&N® intake tube onto the throttle body and align with the tube mounting bracket that was installed in step #14.



19. Secure the K&N® intake tube to the tube mounting bracket with the provided hardware and then tighten the hose clamp at the throttle body.

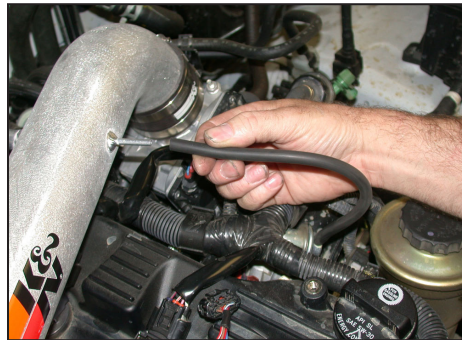

20. Install the provided vacuum hose onto the fuel pressure regulator and then onto the K&N® intake tube as shown.



21. Install the provided crank case vent hose onto the valve cover port and then onto the K&N® intake tube as shown.

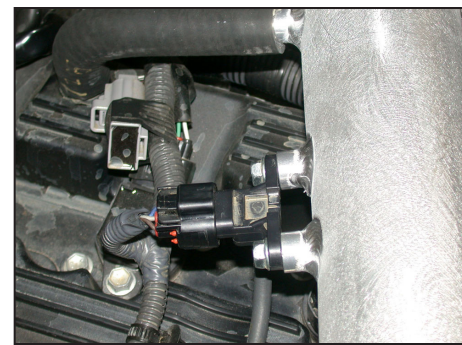

22. Install the pressure sensor onto the K&N® intake tube using the bolts removed in step #3.



23. Install the radius filter adapter into the K&N® air filter and secure with the provided hardware as shown.



24. Install the provided silicone hose (084055) onto the K&N® air filter and secure with the provided hose clamp as shown.



25. Install the air filter assembly onto the intake tube as shown.

**NOTE: Drycharger® air filter wrap; part # RF-1042DK is available to purchase separately. To learn more about Drycharger® filter wraps or look up color availability please visit <http://www.knfilters.com>.**



26. Clip the mass air sensor wire harness retainer into the tube-mounting bracket as shown.



27. Reconnect the mass air sensor electrical connection as shown.

**NOTE: It may be necessary to clip some of the tie wraps securing the ground wire and harness together to prevent the mass air sensor wiring from being too tight.**



28. Reconnect the vehicle's negative battery cable. Double check to make sure everything is tight and properly positioned before starting the vehicle.

29. It will be necessary for all K&N® high flow intake systems to be checked periodically for realignment, clearance and tightening of all connections. Failure to follow the above instructions or proper maintenance may void warranty.

**ROAD TESTING:**

1. Start the engine with the transmission in neutral or park, and the parking brake engaged. Listen for air leaks or odd noises. For air leaks secure hoses and connections. For odd noises, find cause and repair before proceeding. This kit will function identically to the factory system except for being louder and much more responsive.
2. Test drive the vehicle. Listen for odd noises or rattles and fix as necessary.
3. If road test is fine, you can now enjoy the added power and performance from your kit.
4. K&N Engineering, Inc., requires cleaning the intake system's air filter element every 100,000 miles. When used in dusty or off-road environments, our filters will require cleaning more often. We recommend that you visually inspect your filter once every 25,000 miles to determine if the screen is still visible. When the screen is no longer visible some place on the filter element, it is time to clean it. To clean and re-oil, purchase our filter Recharger® service kit, part number 99-5050 or 99-5000 and follow the easy instructions.

**LEGAL IN CALIFORNIA ONLY FOR RACING VEHICLES  
WHICH MAY NEVER BE USED, REGISTERED  
OR LICENSED FOR USE UPON A HIGHWAY.**

See [knfilters.com](http://knfilters.com) for CARB status on each part for a specific vehicle

\* FREE K&N® decal To register your warranty, please see us online at [knfilters.com/register](http://knfilters.com/register). FREE K&N® decal \*