



NOT LEGAL FOR SALE OR USE ON ANY POLLUTION CONTROLLED MOTOR VEHICLE IN CALIFORNIA OR STATES ADOPTING CALIFORNIA EMISSION PROCEDURES.

See knfilters.com for CARB status on each part for a specific vehicle

INSTALLATION INSTRUCTIONS

77-3086KTK

CHEVROLET / GMC

2015 Silverado 2500HD / 3500HD

2015 Sierra 2500HD / 3500HD

V8-6.0L

NOTE: This kit was not designed to fit vehicles with a body lift.

TOOLS NEEDED:

ratchet
extension
10mm socket
flat blade screw driver
phillips screw driver
t15 torx
3mm allen key
4mm allen key

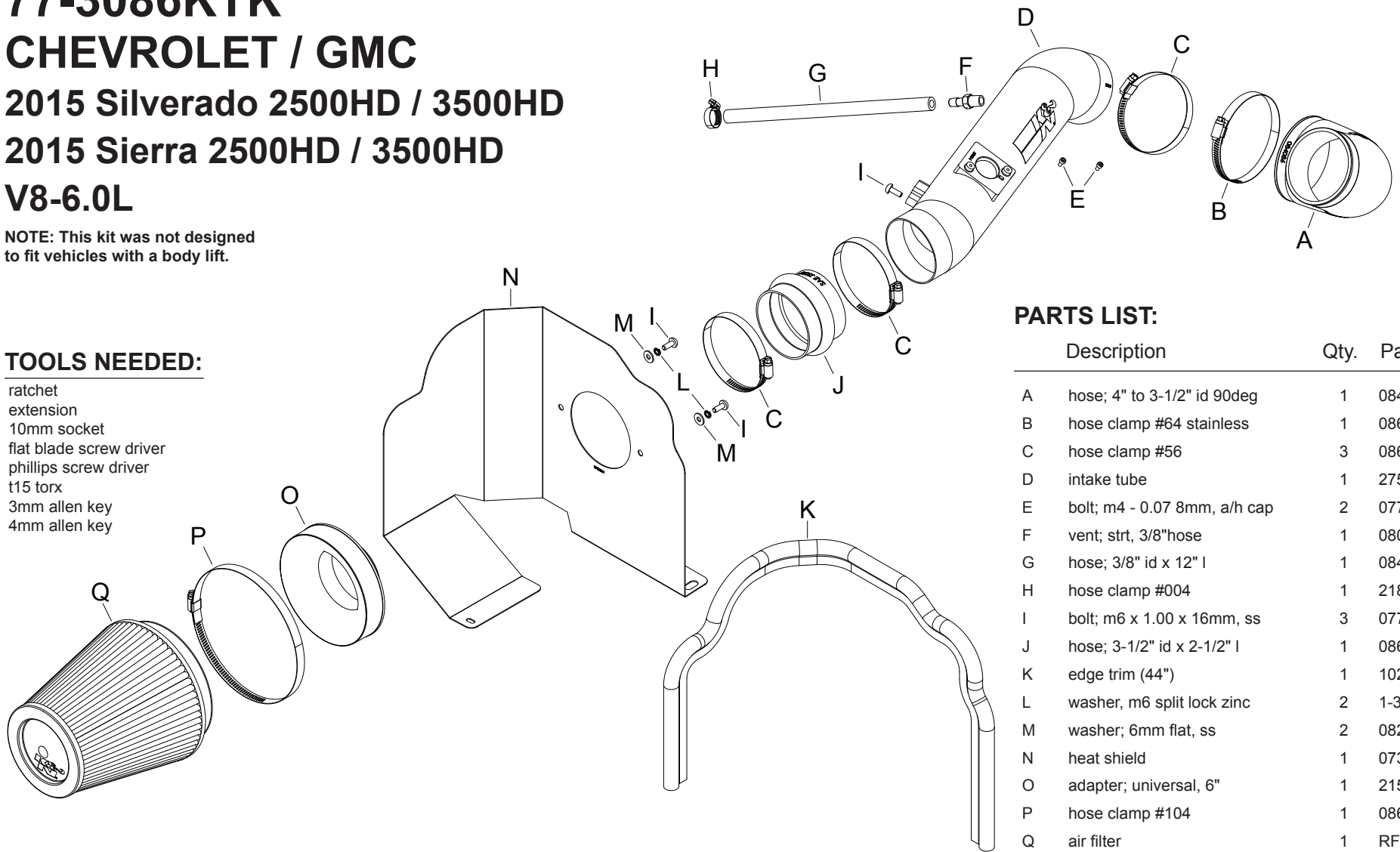

PARTS LIST:

Description	Qty.	Part #
A hose; 4" to 3-1/2" id 90deg	1	084086
B hose clamp #64 stainless	1	08645
C hose clamp #56	3	08620
D intake tube	1	27565TK
E bolt; m4 - 0.07 8mm, a/h cap	2	07733
F vent; str, 3/8" hose	1	08047
G hose; 3/8" id x 12" l	1	08412
H hose clamp #004	1	21850
I bolt; m6 x 1.00 x 16mm, ss	3	07730
J hose; 3-1/2" id x 2-1/2" l	1	08699
K edge trim (44")	1	102486
L washer, m6 split lock zinc	2	1-3025
M washer; 6mm flat, ss	2	08269
N heat shield	1	073155-1
O adapter; universal, 6"	1	21512-1
P hose clamp #104	1	08697
Q air filter	1	RF-1041

NOTE: FAILURE TO FOLLOW INSTALLATION INSTRUCTIONS AND NOT USING THE PROVIDED HARDWARE MAY DAMAGE THE INTAKE TUBE, THROTTLE BODY AND ENGINE.

TO START:

1. Turn off the ignition and disconnect the negative battery cable.

NOTE: Disconnecting the negative battery cable erases pre-programmed electronic memories. Write down all memory settings before disconnecting the negative battery cable. Some radios will require an anti-theft code to be entered after the battery is reconnected. The anti-theft code is typically supplied with your owner's manual. In the event your vehicles anti-theft code cannot be recovered, contact an authorized dealership to obtain your vehicles anti-theft code.

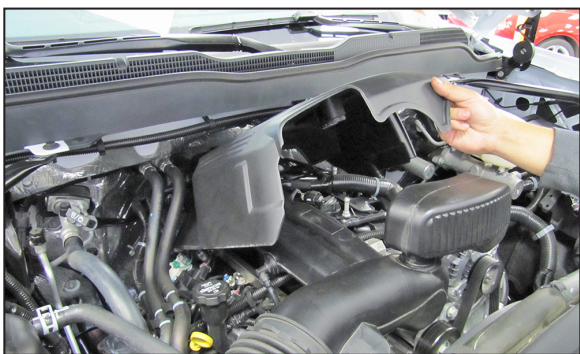

2. Lift up and remove the engine cover from the engine.

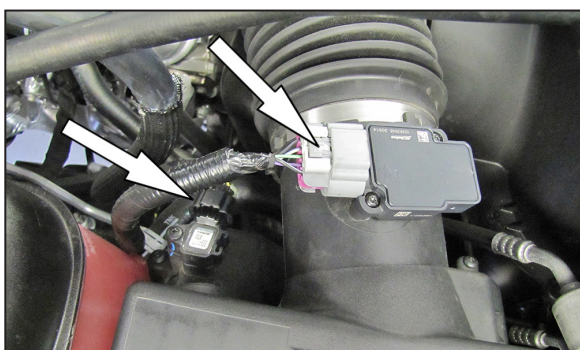

3. Disconnect the mass air sensor and humidity sensor electrical connections.

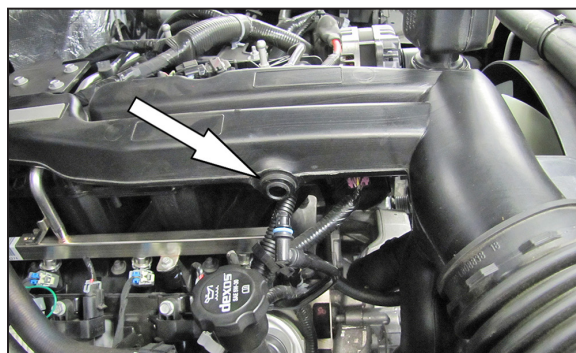

4. Disconnect the crank case vent hose from the intake tube plenum as shown.

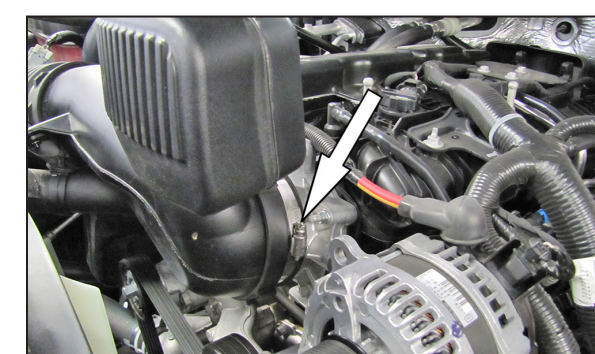
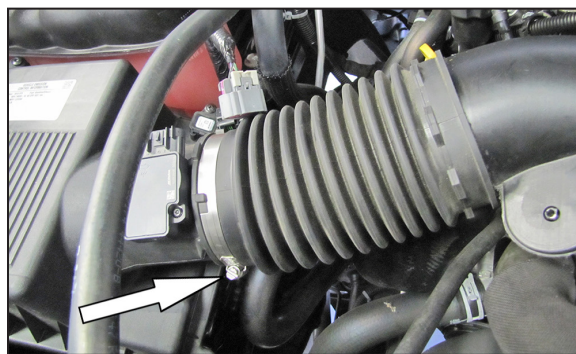

5. Loosen the hose clamps that secure the intake tube to the throttle body and air filter housing. Unhook the radiator hose clip from the intake tube and then remove the intake tube from the vehicle.



6. Lift up the air box to dislodge it from the mounting grommets, and then remove it from the vehicle as shown.

NOTE: K&N Engineering, Inc., recommends that customers do not discard factory air intake.

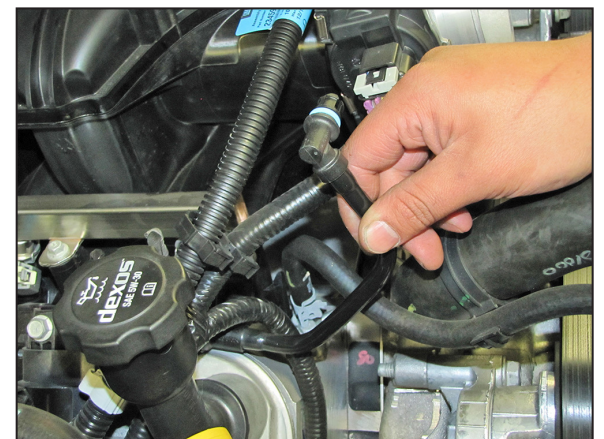

7. Release the locking ring and then disconnect the crank case vent tube from the valve cover vent port.

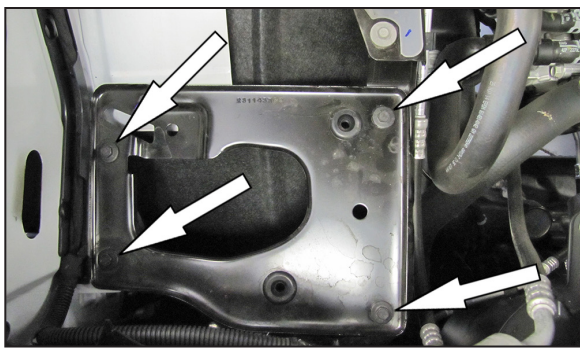

8. Remove the four bolts that secure the air filter mounting tray to the inner fender and then remove the tray.

NOTE: Three of the bolts will be reused in a later step.

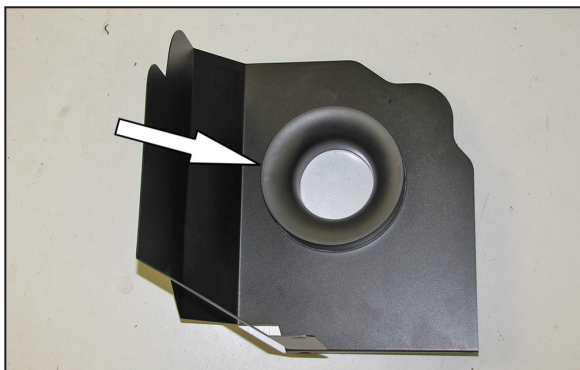

9. Install the provided filter adapter into the heat shield and secure with the provided hardware.



10. Install the provided edge trim onto the heat shield as shown.

NOTE: Some trimming of the edge trim will be necessary.

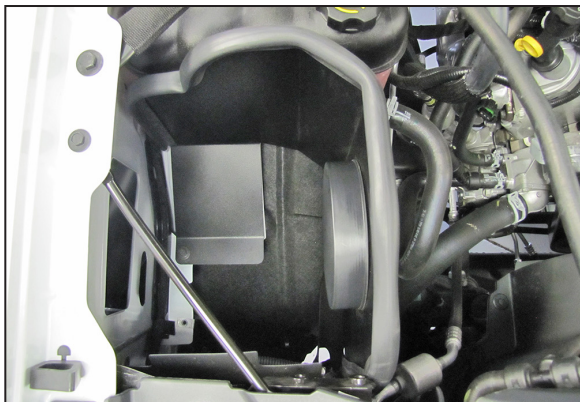

11. Install the heat shield assembly onto the air filter housing mounting plate location and secure with three of the factory bolts from step #8.

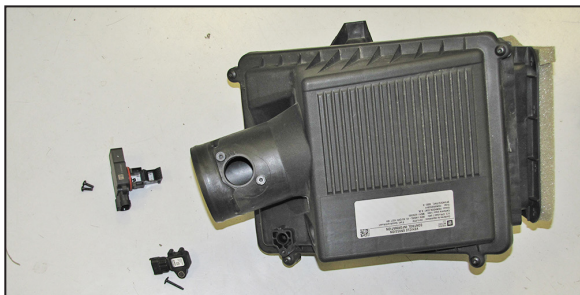

12. Remove the screws securing the mass air sensor and humidity sensors into the air filter housing and then remove the sensors.



13. Install the mass air sensor and humidity sensors into the K&N intake tube and secure with the provided hardware.



14. Install the provided vent fitting into the K&N intake tube as shown.

NOTE: Plastic NPT fittings are easy to cross thread. Install the vent fitting "hand" tight, then turn it two complete turns with a wrench.

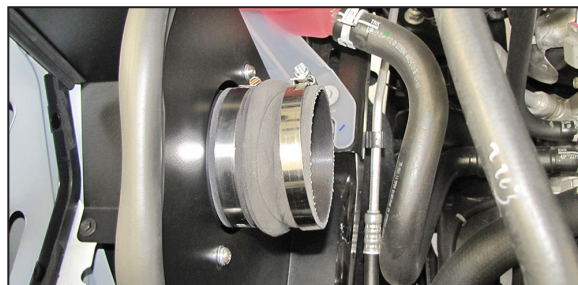

15. Install the provided coupling hose (08699) onto the filter adapter and secure with the provided hose clamp.



16. Install the provided coupler hose (084086) onto the throttle body but do not completely tighten at this time.

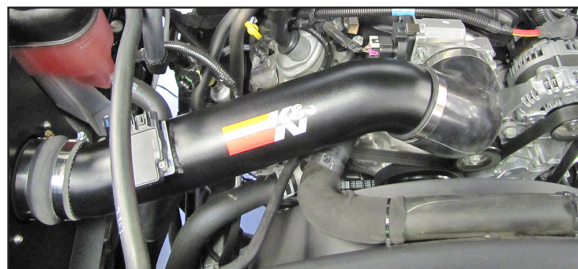

17. Install the K&N intake tube into the coupling hoses and then adjust the tube for best fit. Secure the hoses and tube with the provided hose clamps.

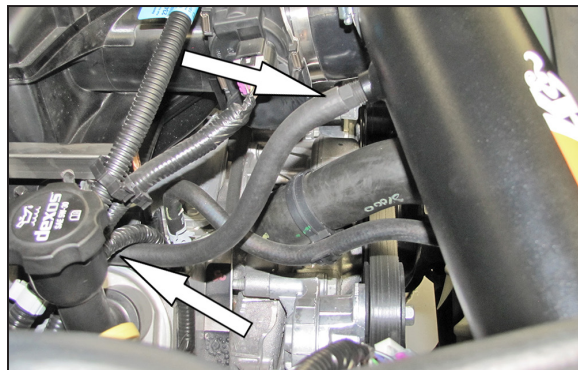

18. Install the provided crank case vent hose onto the fitting installed into the K&N intake tube and then onto the valve cover port. Secure the hose to the valve cover port with the provided hose clamp.

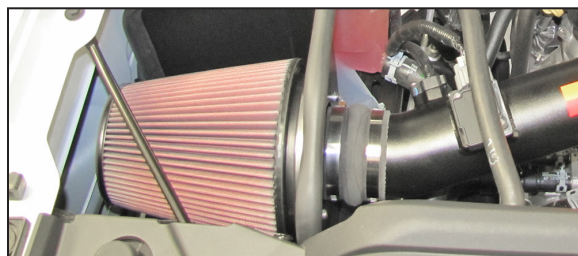

19. Install the K&N air filter and secure with the provided hose clamp.

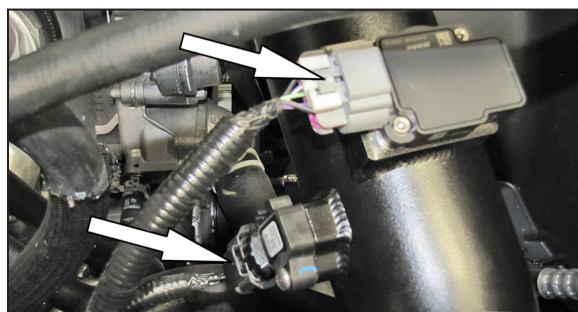

20. Reconnect the mass air sensor and humidity sensor electrical connections.



21. Reinstall the decorative engine cover.



22. Reconnect the vehicle's negative battery cable. Double check to make sure everything is tight and properly positioned before starting the vehicle.

23. **NOTE:** Most General Motors vehicles have the Vehicle Emissions Certification Information (VECI) label affixed to the air filter box. In order to be compliant with California emissions laws, the label **MUST** remain in the engine compartment. If the Vehicle Emission Control Information label is removed during modification, a new replacement label must be obtained and installed in a readily visible position in the engine compartment. The label shall not be affixed to any equipment which is easily detached from the vehicle. We recommend that the label is affixed to the underside of the hood adjacent to the hood latch. The label is Vehicle Identification Number dependent and can be ordered from the vehicle dealership. In order to receive the proper decal please bring your VIN with you. Failure to have the VECI under the hood may result in failure of a pre-registration smog test.

24. It will be necessary for all K&N high flow intake systems to be checked periodically for realignment, clearance and tightening of all connections. Failure to follow the above instructions or proper maintenance may void warranty.

ROAD TESTING:

1. Start the engine with the transmission in neutral or park, and the parking brake engaged. Listen for air leaks or odd noises. For air leaks secure hoses and connections. For odd noises, find cause and repair before proceeding. This kit will function identically to the factory system except for being louder and much more responsive.

2. Test drive the vehicle. Listen for odd noises or rattles and fix as necessary.

3. If road test is fine, you can now enjoy the added power and performance from your kit.

4. K&N Engineering, Inc., requires cleaning the intake system's air filter element every 100,000 miles. When used in dusty or off-road environments, our filters will require cleaning more often. We recommend that you visually inspect your filter once every 25,000 miles to determine if the screen is still visible. When the screen is no longer visible some place on the filter element, it is time to clean it. To clean and re-oil, purchase our filter Recharger service kit, part number 99-5050 or 99-5000 and follow the easy instructions.

NOT LEGAL FOR SALE OR USE ON ANY POLLUTION CONTROLLED MOTOR VEHICLE IN CALIFORNIA OR STATES ADOPTING CALIFORNIA EMISSION PROCEDURES.

See knfilters.com for CARB status on each part for a specific vehicle

* FREE K&N decal To register your warranty, please see us online at knfilters.com/register. FREE K&N decal *